

PROFIBUS

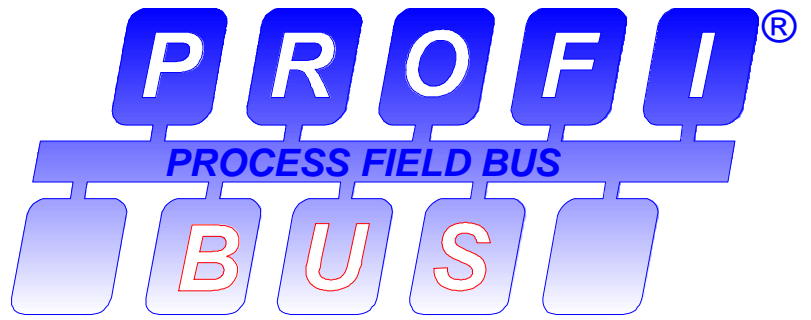

PROFIBUS

Technical Description

September 1999

Technical Description, Order-No. 4.002

September 1999

Published by

PROFIBUS Nutzerorganisation e.V.
Haid-und-Neu-Str. 7
D-76131 Karlsruhe

Phone: ++ 49 721 / 96 58 590
Fax: ++ 49 721 / 96 58 589
e-mail: PROFIBUS_International@compuserve.com
<http://www.profibus.com>

Liability Exclusion

We have tested the contents of this document regarding agreement with the hardware and software described. Nevertheless, deviations can't be excluded, and we are not guaranteeing complete agreement. The data in this document is checked periodically, however. Necessary corrections will be obtained in subsequent versions. We gratefully accept suggestions for improvement. This manual is not a substitute for the PROFIBUS standard EN 50170. In case of doubt, EN 50170 takes precedence.

Contents

1. Industrial Communication	2
2. PROFIBUS Technology	3
2.1 Communication Profiles	3
2.2 Physical Profiles	3
2.3 Application Profiles	4
3. Basic Characteristics	4
3.1 Protocol Architecture	5
3.2 RS-485 Transmission Technology	5
3.3 IEC 1158-2 Transmission Technology	7
3.4 Fiber Optic Transmission	10
3.5 PROFIBUS Medium Access Protocol	10
4. DP Communication Profile	12
4.1 Basic Functions	12
4.1.1 Basic Characteristics	13
4.1.2 System Configuration and Types of Devices	13
4.1.3 System behavior	14
4.1.4 Cyclic Data Transmission between the DPM1 and the Slaves	15
4.1.5 Sync and Freeze Mode	15
4.1.6 Protection Mechanisms	15
4.2 Extended DP Functions	16
4.2.1 Addressing with Slot and Index	16
4.2.2 Acyclic Data Transmission between the DPM1 and the Slaves	16
4.2.3 Acyclic Data Transmission between DPM2 and the Slaves	17
5. FMS Communication Profile	18
5.1 FMS Services	19
5.2 Lower Layer Interface (LLI)	19
5.3 Network Management	20
6. Application Profiles	20
6.1 Process Automation (PA)	20
6.1.1 Communication Aspects	21
6.1.2 Application aspects	22
6.1.3 PA Function Blocks	23
6.2 Failsafe Applications	24
6.3 Building automation	24
6.4 Application Profiles for Special Device Types	25
7. Device Engineering	25
7.1 GSD Files	25
7.2 Ident Number	26
7.3 Electronic Device Description (EDD)	26
7.4 FDT Concept	27
8. Implementation Options	27
8.1 Implementation of Simple Slaves	27
8.2 Implementation of Intelligent Slaves	28
8.3 Implementation of Complex Masters	28
8.4 Implementation of IEC 1158-2 Interfaces	28
9. Device Certification	28
10. Further Technical Developments	30
11. Outlook	32
12. List of Abbreviations	33

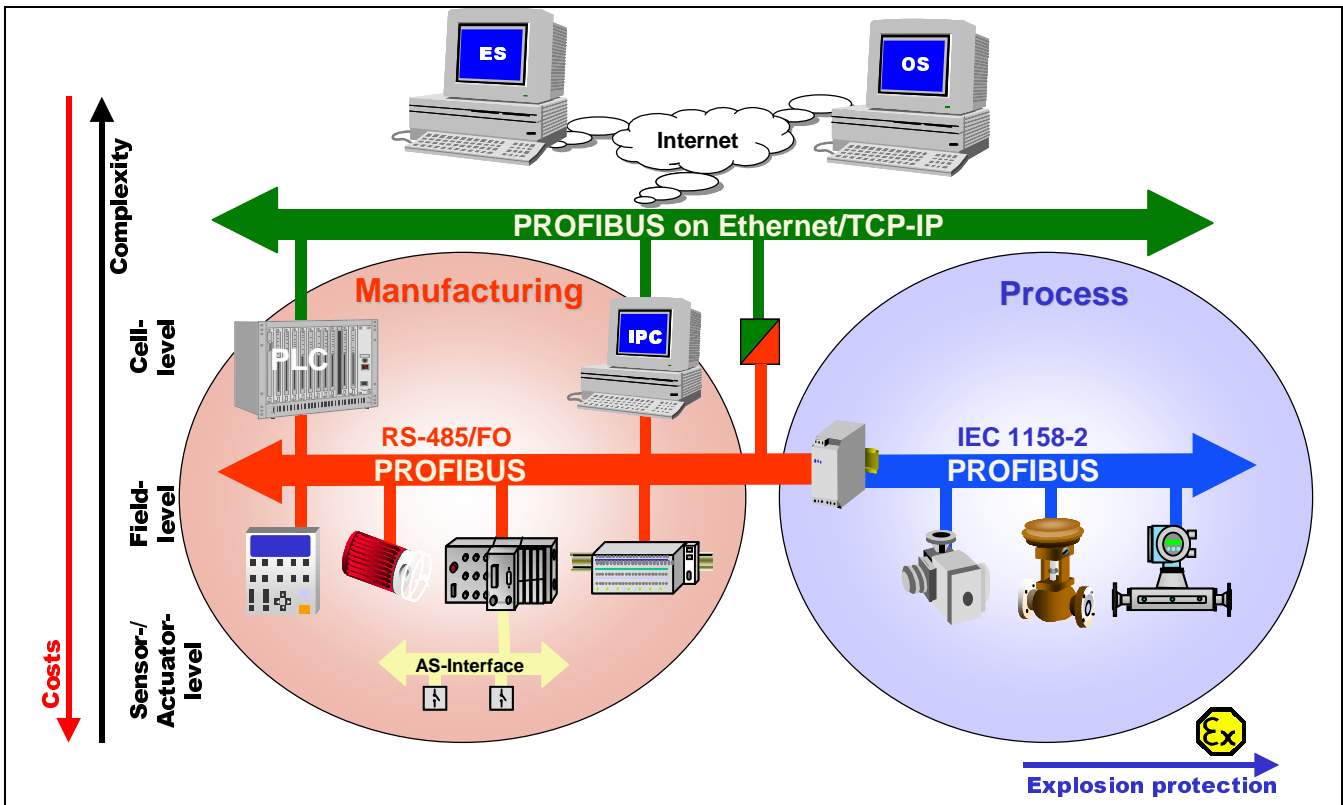

Fig. 1: Industrial Communication

1. Industrial Communication

Information technology (IT) is increasingly determining growth in automation technology. It has changed hierarchies, structures and flows in the entire office world and now covers all sectors – from the process and manufacturing industries to logistics and building automation. The communications capability of devices and continuous, transparent information routes are indispensable components of future-oriented automation concepts. Communication is becoming increasingly direct, horizontally at field level as well as vertically through all hierarchy levels. Depending on the application and the price, graduated, matching industrial communication systems such as Ethernet, PROFIBUS and AS-Interface offer the ideal preconditions for transparent networking in all areas of the production process.

At **actuator/sensor level** the signals of the binary sensors and actuators are transmitted via a sensor/actuator bus. Here, a particularly simple, low-cost installation technique, through which data and a 24-volt power supply for the end devices are transmitted using a common medium, is an important requirement. The data are transmitted purely cyclically. AS-Interface is a suitable bus system for this field of applications.

At **field level** the distributed peripherals, such as I/O modules, measuring transducers, drive units, valves and operator terminals communicate with the automation systems via an efficient, real-time

communication system. The transmission of the process data is effected cyclically, while alarms, parameters and diagnostic data also have to be transmitted acyclically if necessary. PROFIBUS meets these requirements and offers a transparent solution for manufacturing as well as for process automation.

At **cell level**, the programmable controllers such as PLC and IPC communicate with each other. The information flow requires large data packets and a large number of powerful communication functions. Smooth integration into company-wide communication systems, such as Intranet and Internet via TCP/IP and Ethernet are important requirements.

The IT revolution in automation technology is opening up new savings potentials in the optimization of system processes and makes an important contribution towards improved use of resources. Industrial communication systems have assumed a key function in this respect. The following provides a detailed explanation of PROFIBUS as a central link in the flow of information in automation. For a description of AS-Interface, please refer to the relevant literature. The integration of PROFIBUS technology in cross-factory communication networks on the basis of TCP/IP is explained in detail in the chapter "Further Technical Developments".

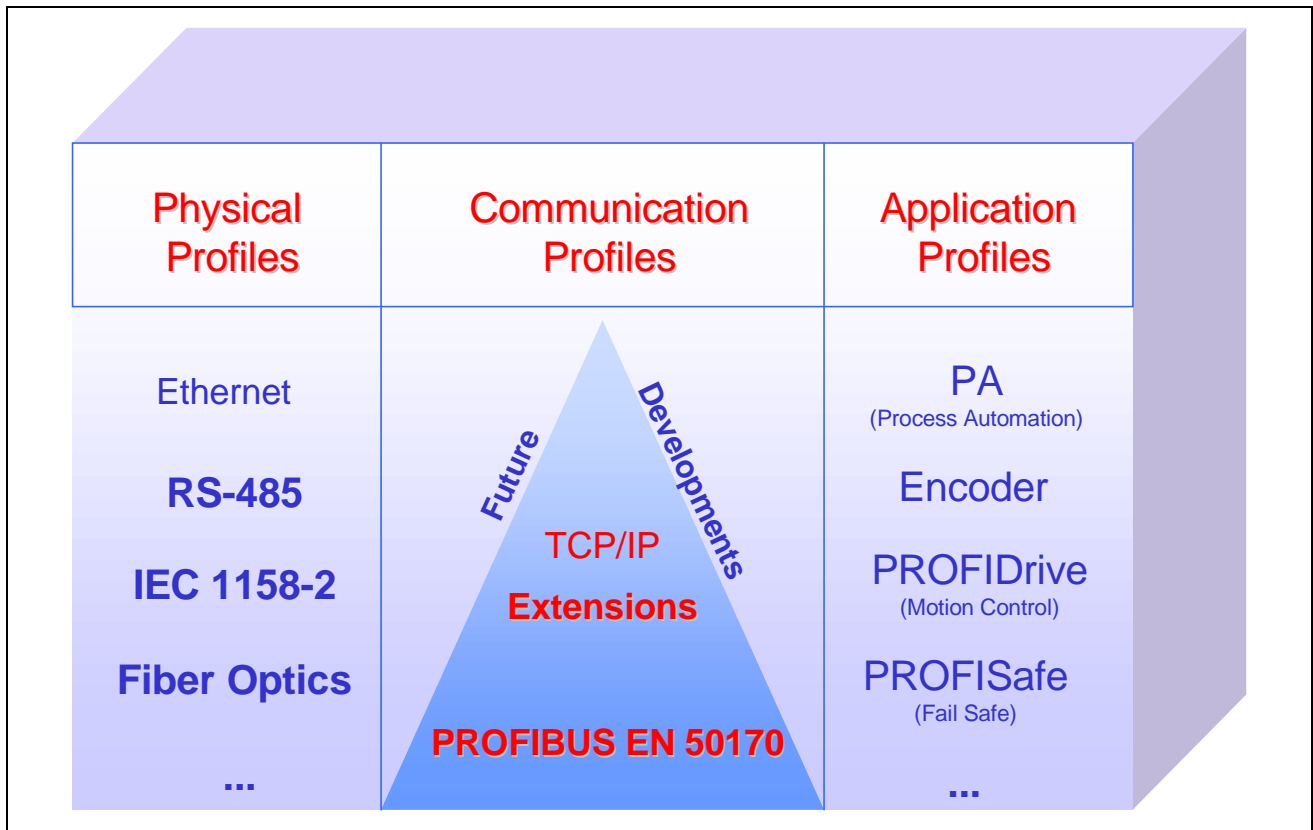

Fig. 2: PROFIBUS & Ethernet

2. PROFIBUS Technology

PROFIBUS is a vendor-independent, open field bus standard for a wide range of applications in manufacturing and process automation. Vendor-independence and openness are ensured by the international standards EN 50170 and EN 50254. PROFIBUS allows communication between devices of different manufacturers without any special interface adjustment. PROFIBUS can be used for both high-speed time critical applications and complex communication tasks. Through its continuing further technical developments, PROFIBUS is still the industrial communication system prepared for the future.

PROFIBUS offers functionally graduated communication protocols (**Communication Profiles**): DP and FMS. Depending on the application, the transmission technologies (**Physical Profiles**) RS-485, IEC 1158-2 or fiber optics are available. In the course of further technical development, the PROFIBUS User Organization is currently working on the implementation of universal concepts for vertical integration on the basis of TCP/IP.

Application Profiles define the options of protocol and transmission technology required in the respective application area for the individual device types. These profiles also define vendor-independent device behavior.

2.1 Communication Profiles

PROFIBUS Communication Profiles define how users transmit their data serially via the common transmission medium.

DP

DP is the most frequently used communication profile. It is optimized for speed, efficiency and low connection costs and is designed especially for communication between automation systems and distributed peripherals. DP is suitable as a replacement for conventional, parallel signal transmission with 24 volts in manufacturing automation as well as for analog signal transmission with 4 ... 20 mA or Hart in process automation.

FMS

This is the universal communication profile for demanding communication tasks. FMS offers many sophisticated application functions for communication between intelligent devices. However, as a result of the further technical development of PROFIBUS and the use of TCP/IP at cell level, FMS will play an increasingly less significant role in the future.

2.2 Physical Profiles

The application area of a field bus system is largely determined by the choice of transmission technology available. As well as the general demands made on bus systems, such as high

transmission reliability, large distances and high transmission speed, in process automation additional requirements must also be satisfied, such as operation in hazardous areas and the transmission of data and energy on a common cable. Since it is not yet possible to satisfy all requirements with a single transmission technology, there are currently three transmission methods (Physical Profiles) available for PROFIBUS:

- RS-485 transmission for universal applications in manufacturing automation.
- IEC 1158-2 transmission for use in process automation.
- Optical fibers for improved interference immunity and large network distances.

In the course of further technical developments, it is intended to use commercial Ethernet components with 10 Mbit/s and 100 Mbit/s as physical layer for PROFIBUS.

Couplers or links are available for the transition between the various transmission technologies. While couplers transparently implement the protocol taking account of physical circumstances, links are intrinsically intelligent and thus offer extended options for the configuration of PROFIBUS networks.

2.3 Application Profiles

PROFIBUS Application Profiles describe the interaction of the communications protocol with the transmission technology being used. They also define the behavior of the field devices during

communication via PROFIBUS. The most important PROFIBUS Application Profile is currently the PA profile, which defines the parameters and function blocks of process automation devices, such as measuring transducers, valves and positioners. Further profiles for variable-speed drives, HMI and encoders define the vendor-independent communication and behavior of the respective device types.

3. Basic Characteristics

PROFIBUS defines the technical characteristics of a serial field bus system with which distributed digital programmable controllers can be networked, from field level to cell level. PROFIBUS is a multi-master system and thus allows the joint operation of several automation, engineering or visualization systems with their distributed peripherals on one bus. PROFIBUS distinguishes between the following types of device:

Master devices determine the data communication on the bus. A master can send messages without an external request when it holds the bus access rights (the token). Masters are also called active stations.

Slave devices are peripherals such as I/O devices, valves, drives and measuring transducers. They do not have bus access rights and they can only acknowledge received messages or send messages to the master when requested to do so. Slaves are called passive stations. Since they only require a small portion of the bus protocol, their implementation is particularly economical.

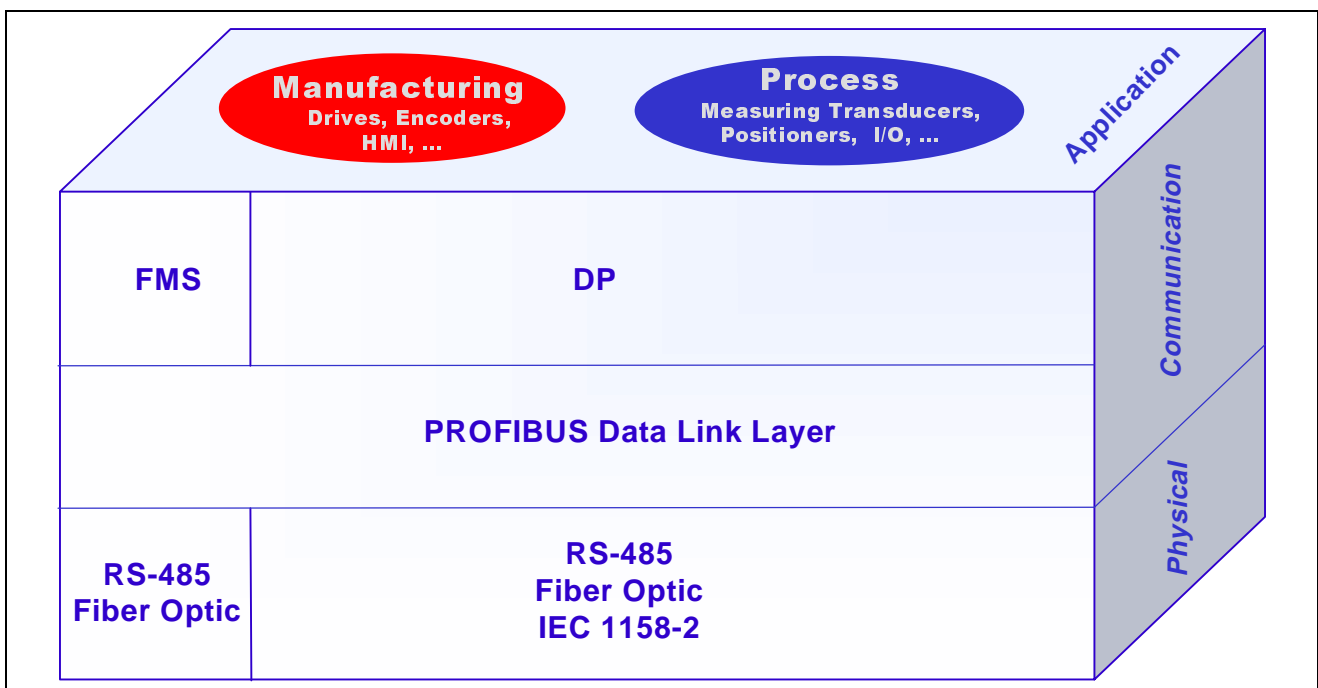

Fig. 3: Overview of PROFIBUS technology

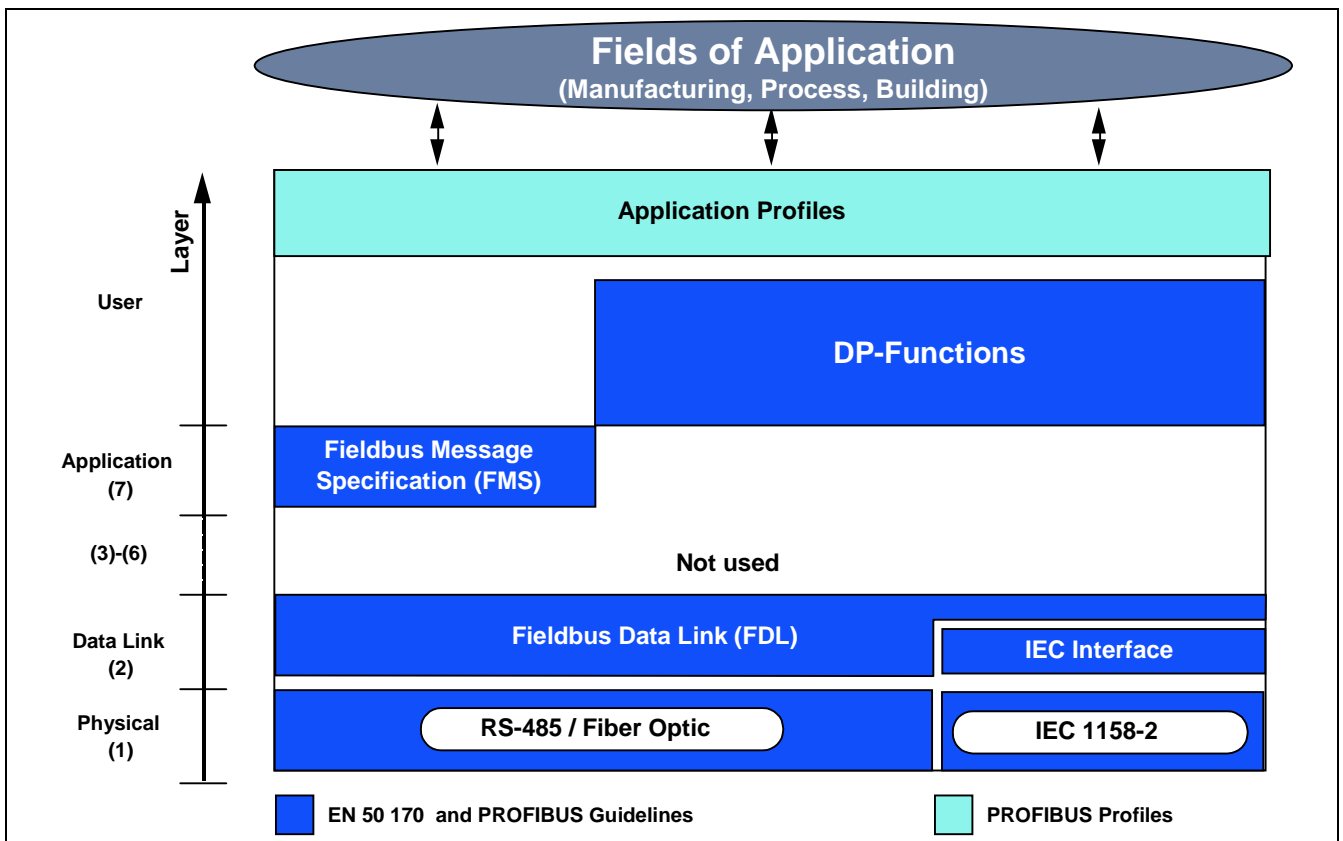

Fig. 4: Protocol architecture

3.1 Protocol Architecture

PROFIBUS is based on recognized international standards. The protocol architecture is oriented to the OSI (Open System Interconnection) reference model in accordance with the international standard ISO 7498. In this model every transmission layer handles precisely defined tasks. Layer 1 (physical layer) defines the physical transmission characteristics. Layer 2 (data link layer) defines the bus access protocol. Layer 7 (application layer) defines the application functions. The architecture of the PROFIBUS protocol is shown in Fig. 4.

DP, the efficient communications protocol, uses layers 1 and 2 as well as the user interface. Layers 3 to 7 are not used. This streamlined architecture ensures fast and efficient data transmission. The Direct Data Link Mapper (DDLMM) provides the user interface easy access to layer 2. The application functions available to the user, as well as the system and device behavior of the various DP device types, are specified in the user interface.

In **FMS**, the universal communications protocol, particular importance is attached to layers 1, 2 and 7. The application layer (7) consists of the Fieldbus Message Specification (FMS) and the Lower Layer Interface (LLI). FMS defines a large number of powerful communication services for master-master and master-slave communication. The LLI defines

the representation of the FMS services on the data transmission protocol of layer 2.

3.2 RS-485 Transmission Technology

RS 485 transmission is the transmission technology most frequently used by PROFIBUS. The application area includes all areas in which high transmission speed and simple, inexpensive installation are required. Twisted pair shielded copper cable with one conductor pair is used.

The RS 485 transmission technology is easy to handle. Installation of the twisted pair cable does not require expert knowledge. The bus structure permits addition and removal of stations or step-by-step commissioning of the system without influencing the other stations. Later expansions have no effect on stations which are already in operation.

Transmission speeds between 9.6 kbit/sec and 12 Mbit/sec are available. One unique transmission speed is selected for all devices on the bus when the system is commissioned.

Installation Instructions for RS 485

All devices are connected in a bus structure (i.e., line). Up to 32 stations (master or slaves) can be connected in one segment.

Basic Characteristics

Medium	Shielded twisted pair cable.
Number of stations	32 stations in each segment without repeater. With repeaters, this can be extended to 126.
Connectors	Preferably 9-pin D-sub connector for IP 20 M12, HAN-BRID or Siemens hybrid connector for IP65/67

Table 1: Basic characteristics of RS-485 transmission technology

The bus is terminated by an active bus terminator at the beginning and end of each segment (see Fig. 6). To ensure error-free operation, both bus terminators must always be powered. The bus terminator can usually be switched in the devices or in the bus terminator connectors.

In the case of more than 32 users, or to enlarge the area of the network, repeaters (line amplifiers) must be used to link up the individual bus segments.

The maximum cable length depends on the transmission speed, see Table 2. Cable length specifications in Table 2 are based on type-A cable with the following parameters:

- Impedance: 135 to 165 Ω
- Capacity: < 30 pf/m
- Loop resistance: 110 Ω /km
- Wire gauge: 0.64 mm
- Conductor area > 0.34 mm²

The use of cables of the previously used type B is generally not recommended. In degree of protection IP20, the use of a 9-pin D sub connector is preferable for PROFIBUS networks using RS 485 transmission technology. The pin assignment of the connector and the wiring are shown in Figure 6. Three alternative connections are possible for RS-485 transmission using degree of protection IP65/67:

- M12 circular connector according to IEC 947-5-2
- HAN-BRID connector according to DESINA recommendations
- Siemens hybrid connector

The HAN-Brid connector system also offers a variant for transmitting data via fiber optic and 24 volt power supply for peripherals via copper cable in a common hybrid cable.

PROFIBUS cables are offered by various well-known manufacturers. A particular feature is the fast-connect system which, thanks to a special cable and special cable stripper, allows fast, reliable and extremely simple wiring.

When connecting the stations, make sure that the data lines are not reversed. Use of shielded data lines is absolutely essential for achieving high

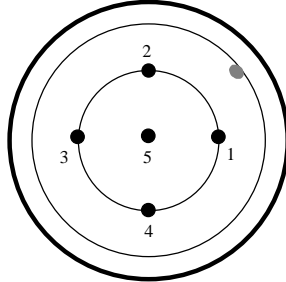

M12 Connector for RS-485 in IP65/67
Pin assignment: 1: VP, 2: RxD/TxD-N
3: DGND; 4: RxD/TxD-P; 5: Shield

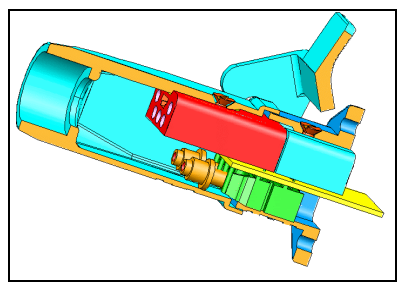

Han-Brid Connector in Cu-Fo Version
for transmission of data via the fibers and 24 volt power supply for the peripherals in a single connector. This connector is also available in Cu/Cu version.

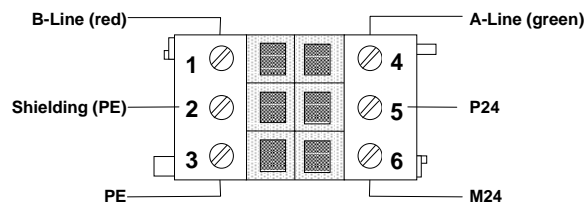

Siemens-Hybrid-Connector for transmission of both 24 volt power supply and PROFIBUS data via copper wires for devices with IP 65 protection.

Fig. 5: Options for PROFIBUS connectors in protection class IP 65/67.

Baud rate (kbit/s)	9.6	19.2	93.75	187.5	500	1500	12000
Range/Segment	1200 m	1200 m	1200 m	1000 m	400 m	200 m	100 m

Table 2: Range based on transmission speed for type-A cable

system immunity against high electromagnetic emissions. The shield should be connected to protective ground on both sides and with good conductivity using large-area shield clamps. In addition, it is recommended that data lines be kept separate from all high-voltage cables. The use of stub lines must be avoided for data transmission speeds of ≥ 1.5 Mbit/s. Commercially available plug connectors permit the incoming data cable and the outgoing data cable to be connected directly in the connector. This means that stub lines do not have to be used, and the bus connector can be connected and disconnected at the bus at all times without interrupting data communication.

Whenever problems occur in PROFIBUS networks, in 90 % of all cases they can be attributed to incorrect wiring and installation. These problems can often be solved using bus testers, which can detect many typical wiring faults even before commissioning. For the addresses of suppliers of the many different connectors, cables, repeaters and bus-testers, please refer to the PROFIBUS Product Guide.

3.3 IEC 1158-2 Transmission Technology

Synchronous transmission in accordance with IEC 1158-2 with a defined baud rate of 31.25 kbit/s is used in process automation. It satisfies important requirements in the chemical and petrochemical industries: intrinsic safety and powering over the bus using two-wire technology. Thus PROFIBUS

can be used in hazardous areas.

The options and limits of PROFIBUS with IEC 1158-2 transmission technology for use in potentially explosive areas are defined by the FISCO model (Fieldbus Intrinsically Safe Concept). The FISCO model was developed in Germany by the Physikalisch Technische Bundesanstalt (PTB) (Federal Physical Technical Institute) and is today internationally recognized as the basic model for fieldbuses in hazardous areas. Transmission in accordance with IEC 1158-2 and FISCO model is based on the following principles:

- Each segment has only one source of power, the power supply unit.
- No power is fed to the bus when a station is sending.
- Every field device consumes a constant basic current at steady-state.
- The field devices function as a passive current sink.
- The passive line termination is performed at both ends of the main bus line.
- Linear, tree and star topologies are allowed.

In steady state, each station consumes a basic current of at least 10 mA. With bus powering, this current serves to supply energy to the field device. Communication signals are generated by the sending device by modulation from ± 9 mA to the basic current.

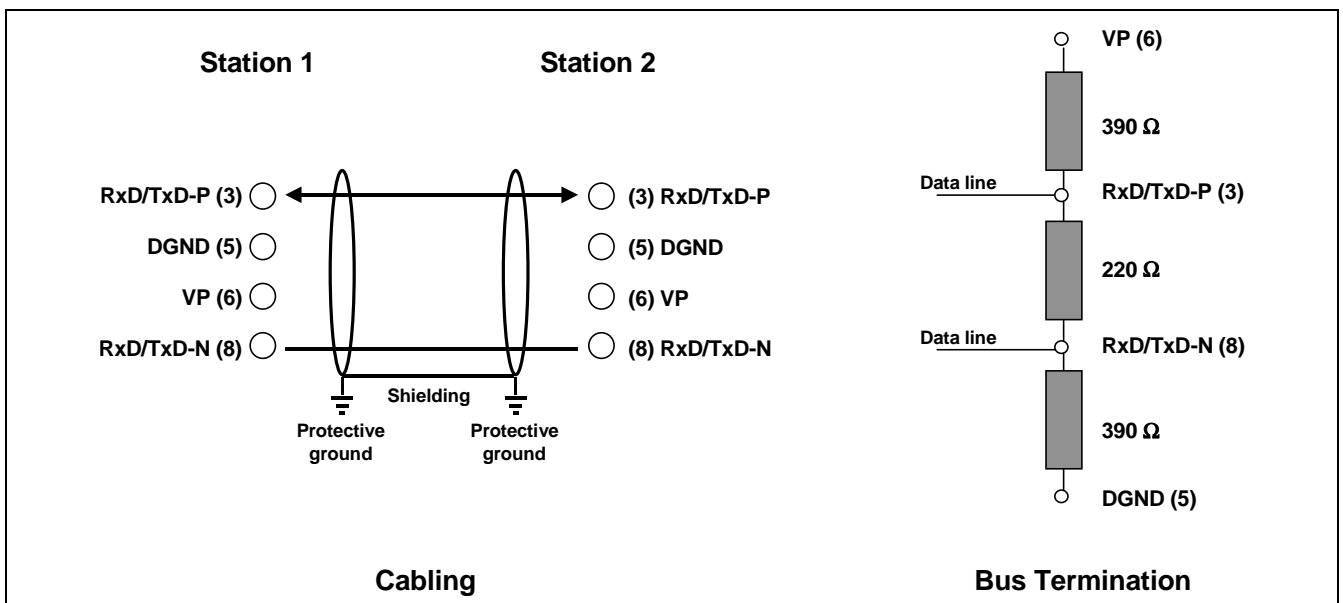

Fig. 6: Wiring and bus termination for RS-485 transmission in PROFIBUS

Basic Characteristics

Data transmission	Digital, bit-synchronous, Manchester coding
Transmission speed	31,25 kbit/s, Voltage Mode
Data security	Preamble, error-proof start and end delimiter
Cable	Two wire shielded twisted pair cable
Remote powering	Optional, via data lines
Explosion protection classes	Intrinsically safe (EEx ia/ib) and encapsulation (EEx d/m/p/q)
Topology	Line and tree topologies, or a combination
Number of stations	Up to 32 stations per line segment, maximum total of 126
Repeater	Can be expanded with up to 4 repeaters

Table 3: Characteristic features of IEC 1158-2 transmission technology

To operate a PROFIBUS network in hazardous areas, it is necessary for all components used in the hazardous areas to be approved and certified in accordance with the FISCO model and IEC 1158-2 by authorized approval agencies such as PTB, BVS (Germany) UL, FM (US). If all of the components used have been certified as required, and if the following rules for selecting the supply unit, line length and bus terminators are complied with, then no further system approval is required for commissioning of the PROFIBUS network.

Installation Instructions for IEC-1158

The control station usually contains the process control system as well as operating and engineering devices which communicate via PROFIBUS and RS-485 transmission. In the field, a segment coupler or a link forms the transition from the RS-485 segment to the IEC 1158-2 segment. At the same

time, the coupler or link is the supply unit for the bus powered field devices.

Segment couplers are signal converters that adapt the RS-485 signals to the IEC 1158-2 signal level. From the point of view of the bus protocol, they are transparent. If segment couplers are used, the baud rate in the RS-485 segment is restricted to a maximum of 93.75 kbit/s.

Links, on the other hand, have their own intrinsic intelligence. They represent all field devices connected in the IEC 1158-2 segment as a single slave in the RS-485 segment. There is no limit to the baud rate in the RS-485 segment when using links. This means that it is also possible to implement fast networks, i.e. for control functions, including field devices with an IEC 1158-2 connection.

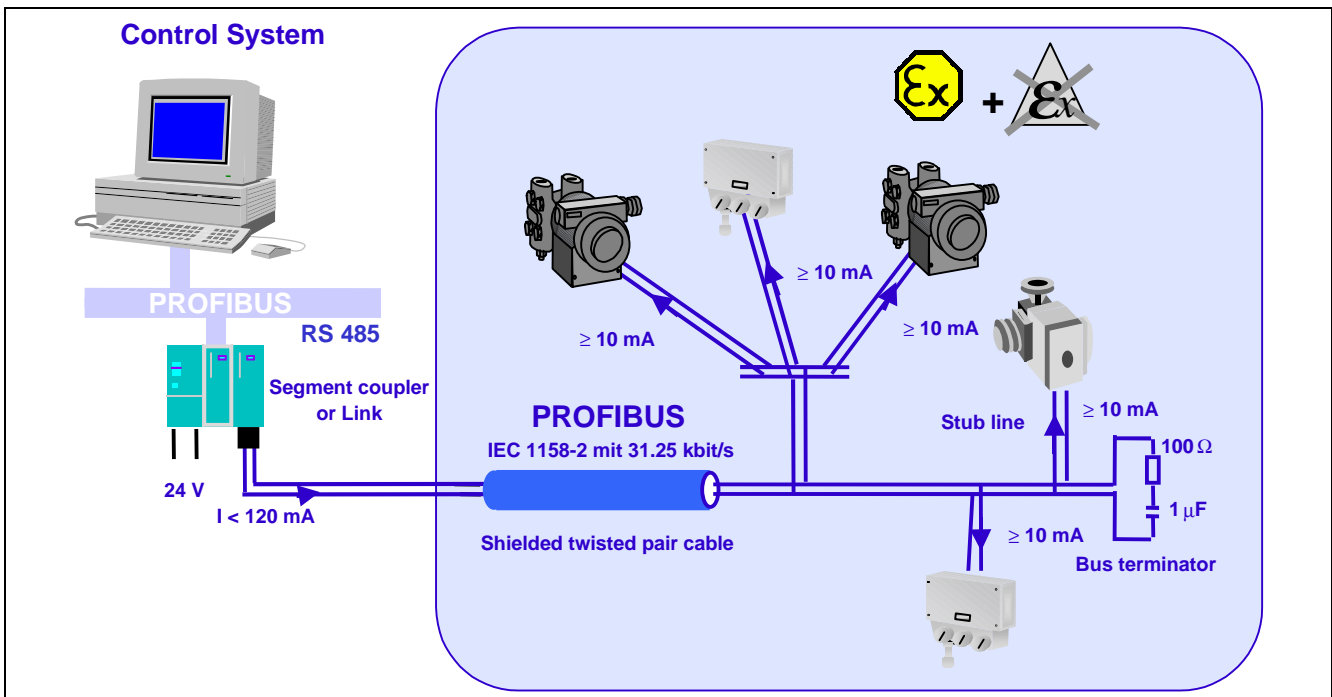

Fig. 7: Bus powering of field devices via PROFIBUS and IEC 1158-2 transmission technology

Cable design	Shielded twisted pair cable
Conductor area (nominal)	0.8 mm ² (AWG 18)
Loop resistance:	44 Ω/km
Impedance at 31.25 kHz	100 Ω ± 20 %
Wave attenuation at 39 kHz	3 dB/km
Capacitive asymmetry	2 nF/km

Table 4: Specification of the reference cable for IEC 1158-2 transmission

Tree or line structures are possible network topologies for PROFIBUS with IEC 1158-2 transmission, as well as any combinations of the two, see Fig. 7.

In a line structure, stations are connected to the main cable using T-connectors. A tree structure can be compared to the classic field installation technique. The multi-core master cable is replaced by the two-wire bus cable. The field distributor continues to be used for connection of the field devices and to house the bus terminating resistor. When a tree structure is used, all field devices connected to the fieldbus segment are wired in parallel in the field distributor.

In all cases, the maximum permissible stub line lengths must be taken into consideration when calculating the total line length. A stub line may not

be longer than 30m in intrinsically safe applications.

A shielded two-wire cable is used as the transmission medium, see Fig.7. The main bus cable is fitted at both ends with a passive line terminator, consisting of an RC element connected in series with $R = 100 \Omega$ and $C = 1 \mu F$. In the segment coupler or link the bus terminator is already permanently integrated. A reversed-polarity connection of a field device using IEC 1158-2 technology has no effect on the correct functioning of the bus, since these field devices are usually fitted with automatic polarity detection.

The number of stations that can be connected to one segment is limited to a maximum of 32. However, this number may be further restricted by the selected type of protection and bus powering. In intrinsically safe networks, the maximum supply voltage as well as the maximum supply current are defined within strict limits. Even when intrinsic safety is not required, the power of the power supply unit is limited.

As a rule of thumb for determining the maximum line length, it is sufficient to calculate the power requirements of the field devices to be connected, to select a supply unit from Table 5 and to read off the line length for the selected type of cable from Table 6. The required current ($=\Sigma$ power requirements) is obtained from the sum of the basic currents of the devices, of the field devices connected in the selected segment, as well as a reserve of 9 mA per segment for the operating current of the FDE (Fault Disconnection Equipment). The FDE

Type	Application	Supply voltage	Maximum supply current	Maximum power	Typical ^{*)} no. of stations
I	EEx ia/ib IIC	13.5 V	110mA	1.8 W	9
II	EEx ib IIC	13.5 V	110mA	1.8 W	9
III	EEx ib IIB	13.5 V	250 mA	4.2 W	22
IV	Not intrinsically safe	24 V	500 mA	12 W	32

*) this is based on power consumption of 10 mA per device. If a device consumes more than 10 mA, the number of devices that can be connected must be reduced accordingly.

Table 5: Standard power supply units (operating values) for PROFIBUS with IEC 1158-2 transmission

Supply unit		Type I	Type II	Type III	Type IV	Type IV	Type IV
Supply voltage	V	13.5	13.5	13.5	24	24	24
Σ Power requirements	mA	≤ 110	≤ 110	≤ 250	≤ 110	≤ 250	≤ 500
Σ Line length for $q=0.8 \text{ mm}^2$ (reference)	m	≤ 900	≤ 900	≤ 400	≤ 1900	≤ 1300	≤ 650
Σ Line length for $q=1.5 \text{ mm}^2$	m	≤ 1000	≤ 1500	≤ 500	≤ 1900	≤ 1900	≤ 1900

Table 6: Line lengths for PROFIBUS with IEC 1158-2 transmission

Type of fiber	Properties
Multimode glass fiber	Medium distance range, 2 – 3 km range
Monomode glass fiber	Long distance range, > 15 km range
Synthetic fiber	Short distance range, > 80 km range
PCS/HCS fiber	Short distance range, > 500 m range

Table 7: Properties of optical fibers

prevents faulty devices from blocking the bus permanently.

Joint operation of bus powered and externally powered devices is permissible. It must be noted that even externally supplied devices consume a basic current via the bus connection, and this must also be taken into account when calculating the maximum available supply current.

3.4 Fiber Optic Transmission

Fiber optic conductors may be used in PROFIBUS for applications in environments with very high electromagnetic interference, for electrical isolation or to increase the maximum network distance for high transmission speeds. Various types of fibers are available, with different characteristics with respect to distance, price and application. For a short overview please refer to Table 7.

PROFIBUS segments using fiber-optic technology are designed using either a star or a ring structure. The PROFIBUS fiber optic components from some manufacturers also allow the creation of redundant fiber optic links with automatic switchover to the alternative physical transmission route in the event of a fault. Many manufacturers also offer couplers between RS-485 transmission links and optical

fibers. This provides a method of switching at any time between RS 485 transmission and fiber optic transmission within one system. See PROFIBUS guideline 2.022 for the specification of the PROFIBUS fiber optic transmission technique. For an overview of the fiber-optic components available for PROFIBUS, please refer to the current PROFIBUS Product Guide.

3.5 PROFIBUS Medium Access Protocol

The PROFIBUS Communication Profiles use a uniform medium access protocol. This protocol is implemented by layer 2 of the OSI reference model. This also includes data security and the handling of the transmission protocols and telegrams. In PROFIBUS, layer 2 is called Fieldbus Data Link (FDL). The Medium Access Control (MAC) specifies the procedure when a station is permitted to transmit data. The MAC must ensure that only one station has the right to transmit data at a time. The PROFIBUS protocol has been designed to meet two primary requirements for the Medium Access Control:

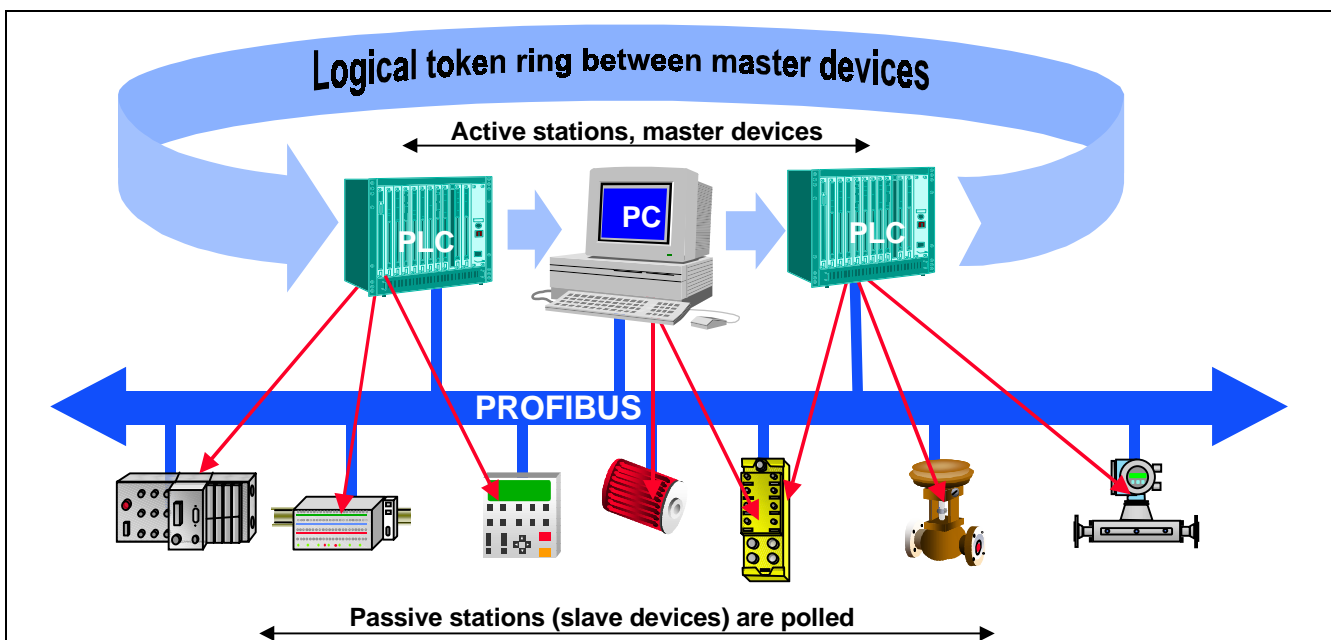

Fig. 8: shows a PROFIBUS configuration with three active stations (masters) and seven passive stations (slaves). The three masters form a logical token ring.

Service	Function	DP	FMS
SDA	Send Data With Acknowledge		•
SRD	Send And Request Data With Reply	•	•
SDN	Send Data With No Acknowledge	•	•
CSRD	Cyclic Send And Request Data With Reply		•

Table 8: Services of the PROFIBUS data link layer (layer 2)

- During communication between complex automation systems (masters), it must be ensured that each of these stations gets sufficient time to perform its communication tasks within a precisely defined time interval.
- On the other hand, for communication between a complex programmable controller and its assigned simple peripherals (slaves), cyclic, real-time data transmission needs to be implemented as fast and as simply as possible.

Therefore, the PROFIBUS medium access protocol (see Figure 8) includes the token passing procedure, which is used by complex bus stations (masters) to communicate with each other, and the master-slave procedure used by complex bus stations to communicate with the simple peripherals (slaves).

The **token passing procedure** ensures that the bus access right (the token) is assigned to each master within a precisely defined timeframe. The token message, a special telegram for passing the token from one master to the next master must be passed around the logical token ring once to all masters within a (configurable) maximum token rotation time. In PROFIBUS the token passing procedure is only used for communication between complex stations (masters).

The **master-slave procedure** permits the master (the active station) which currently owns the token to access the assigned slaves (the passive stations). This enables the master to send messages to, or retrieve them from the slaves. This method of access allows implementation of the following system configurations:

- Pure master-slave system.
- Pure master-master system (token passing)
- A combination of the two

A token ring means the organizational lining up of active stations which form a logical ring through their bus addresses. In this ring, the token, the bus access right, is passed on from one master to the next master in a predefined sequence (increasing

addresses). When an active station receives the token telegram, it can perform the master role for a certain period of time and communicate with all slave stations in a master-slave communication relationship and all master stations in a master-master communication relationship.

The task of the bus access controller (MAC) of the active station is to detect this logical assignment in the startup phase of the bus system and to establish the token ring. During operation, defective or switched-off (active) stations must be removed from the ring and new active stations can be added to the ring. In addition, the bus access control ensures that the token is passed from one master to the next in order of increasing addresses.

The actual token hold time of a master depends on the configured token rotation time. In addition, the detection of defects on the transmission medium and on the line receiver, as well as the detection of errors in station addressing (e.g., multiple addresses assigned) or in token passing (e.g., multiple tokens or token loss) are characteristic features of the PROFIBUS medium access control.

Another important task of layer 2 is **data security**. PROFIBUS layer 2 frame formats ensure high data integrity. All telegrams have a **Hamming Distance of HD=4**. This is achieved through compliance with the international standard IEC 870-5-1, through special telegram start and end delimiters, slip-free synchronization, a parity bit and a check byte.

PROFIBUS layer 2 operates in a connectionless mode. In addition to logical peer-to-peer data transmission, it provides multi-peer communication (broadcast and multicast).

Broadcast communication means that an active station sends an unacknowledged message to all other stations (master and slaves).

Multicast communication means that an active station sends an unacknowledged message to a predetermined group of stations (master and slaves).

The PROFIBUS Communication Profiles each use a specific subset of layer 2 services, see Table 8. The services are called up by the higher-order layers via the service access points (SAPs). In FMS these service access points are used to address the logical communication relationships.

In DP a precisely defined function is assigned to each service access point. Several service access points can be used simultaneously for all active and passive stations. A distinction is made between source (SSAP) and destination service access points (DSAP).

4. DP Communication Profile

The DP Communication Profile is designed for efficient data exchange at the field level. The central automation devices, such as PLC/PC or process control systems, communicate through a fast serial connection with distributed field devices such as I/O, drives and valves, as well as measuring

transducers. Data exchange with the distributed devices is mainly cyclic. The communication functions required for this are defined by the basic DP functions in accordance with EN 50 170. In addition to these basic functions, DP also offers extended acyclic communication services for the parameterization, operation, monitoring and alarm handling of intelligent field devices. They are defined in the PROFIBUS Guideline No. 2.042 and are explained in Chapter 4.2.

4.1 Basic Functions

The central controller (master) cyclically reads the input information from the slaves and cyclically writes the output information to the slaves. The bus cycle time should be shorter than the program cycle time of the central automation system, which for many applications is approximately 10 msec. In addition to cyclic user data transmission, DP provides powerful functions for diagnostics and commissioning. Data communication is monitored by

<p>Bus access:</p> <ul style="list-style-type: none"> • Token passing procedure between masters and master-slave procedure between master and slaves • Mono-master or multi-master systems possible • Master and slave devices, max. 126 stations on one bus
<p>Communication:</p> <ul style="list-style-type: none"> • Peer-to-peer (user data communication) or multicast (control commands) • Cyclic master-slave user data communication
<p>Operating states:</p> <ul style="list-style-type: none"> • Operate: Cyclic transmission of input and output data • Clear: Inputs are read, outputs remain in secure state • Stop: Diagnostics and parameterization, no user data transmission
<p>Synchronization:</p> <ul style="list-style-type: none"> • Control commands allow the synchronization of inputs and outputs • Sync mode: Outputs are synchronized • Freeze mode: Inputs are synchronized
<p>Functions:</p> <ul style="list-style-type: none"> • Cyclic user data transfer between DP master and slave(s) • Dynamic activation or deactivation of individual slaves • Checking the configuration of the slaves • Powerful diagnostic functions, 3 hierarchical levels of diagnostic messages • Synchronization of inputs and/or outputs • Address assignment for slaves optionally possible via the bus • maximum of 244 bytes input and output data possible for each slave
<p>Protective functions:</p> <ul style="list-style-type: none"> • All messages are transmitted at a hamming distance of HD=4 • Watchdog control of DP slave detects failure of the assigned master • Access protection for inputs/outputs of slaves • Monitoring of user data communication with adjustable monitoring timer in the master
<p>Device types:</p> <ul style="list-style-type: none"> • DP master Class 2 (DPM2), e.g. engineering or diagnostics tool • DP master Class 1 (DPM1), e.g. central programmable controllers such as PLC, PC • DP slave e.g. devices with binary or analog inputs/outputs, drives, valves

Table 9: Basic DP functions

monitoring functions on both the master and slave side. Table 9 provides a summary of the basic DP functions.

4.1.1 Basic Characteristics

High data throughput alone is not the sole criteria for successful use of a bus system. Simple handling, good diagnostic capabilities and interference-proof transmission technology are also important to the user. DP represents the optimum combination of these characteristics.

Speed:

DP requires only about 1 msec at 12 Mbit/sec for the transmission of 512 bits of input data and 512 bits of output data distributed over 32 stations. Figure 9 shows the typical DP transmission time, depending on number of stations and transmission speed. Transmitting the input and output data in a single message cycle with DP, results in a significant increase in speed compared to FMS. In DP, user data is transmitted with the SRD service of layer 2.

Diagnostic functions:

The extensive diagnostic functions of DP enable fast location of faults. The diagnostic messages are transmitted over the bus and collected at the master. These messages are divided into three levels:

- **Station-related diagnostics**
These messages concern the general operational status of a station (i.e. overtemperature or low voltage).

- **Module-related diagnostics**
These messages indicate that within a certain I/O range (e.g. 8 bit output module) of a station, diagnostics are pending.
- **Channel-related diagnostics**
In this case, the cause of the fault is specified in relation to an individual input/output bit (channel), e.g. short circuit at output 7.

4.1.2 System Configuration and Types of Devices

DP permits **mono-master or multi-master** systems. This provides a high degree of flexibility during system configuration. A maximum of 126 devices (master or slaves) can be connected to one bus. The system configuration specifications define the number of stations, assignment of station addresses to the I/O addresses, data consistency of the I/O data, format of the diagnostic messages and the bus parameters used. Each DP system consists of different types of devices. A distinction is made between three types of devices:

DP Master Class 1 (DPM1)

This is a central controller which cyclically exchanges information with the distributed stations (slaves) in a defined message cycle. Typical devices are, for example, programmable logic controllers (PLC) or PC.

DP Master Class 2 (DPM2)

Devices of this type are engineering, configuration

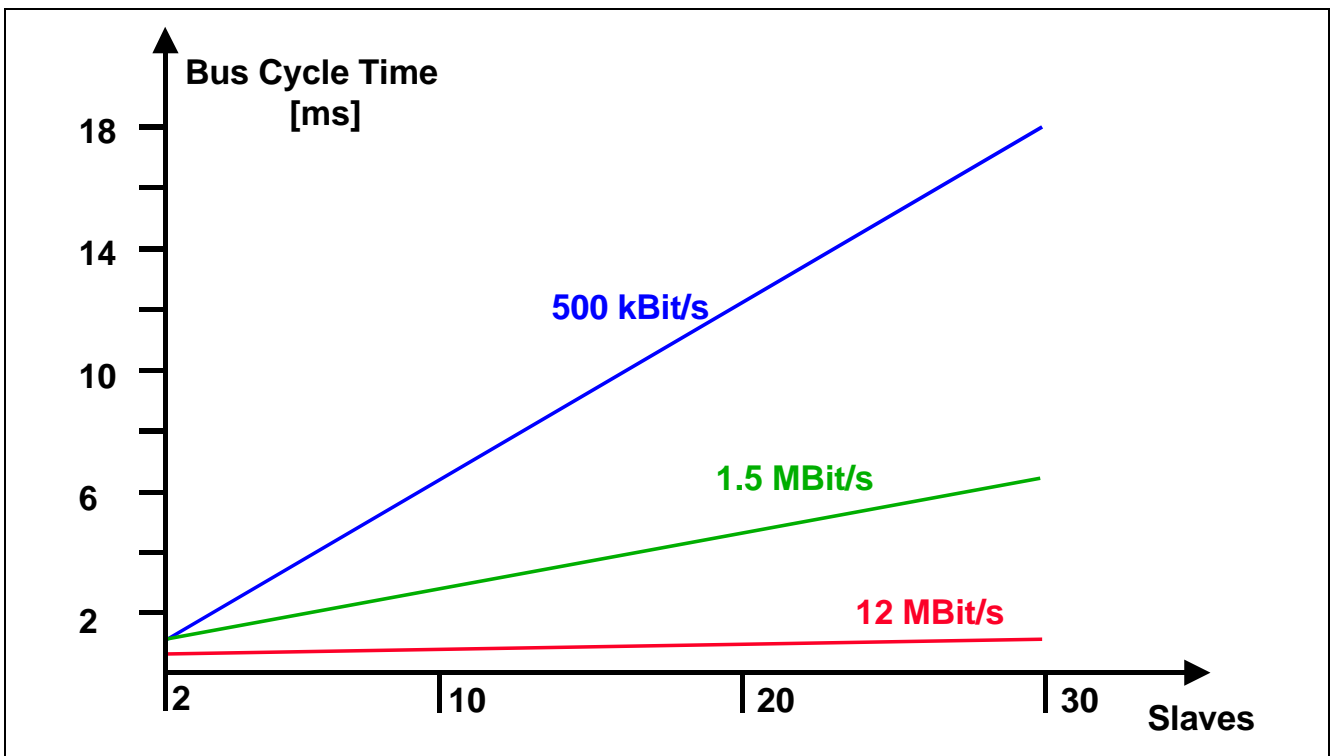

Fig. 9: Bus cycle time of a DP mono-master system

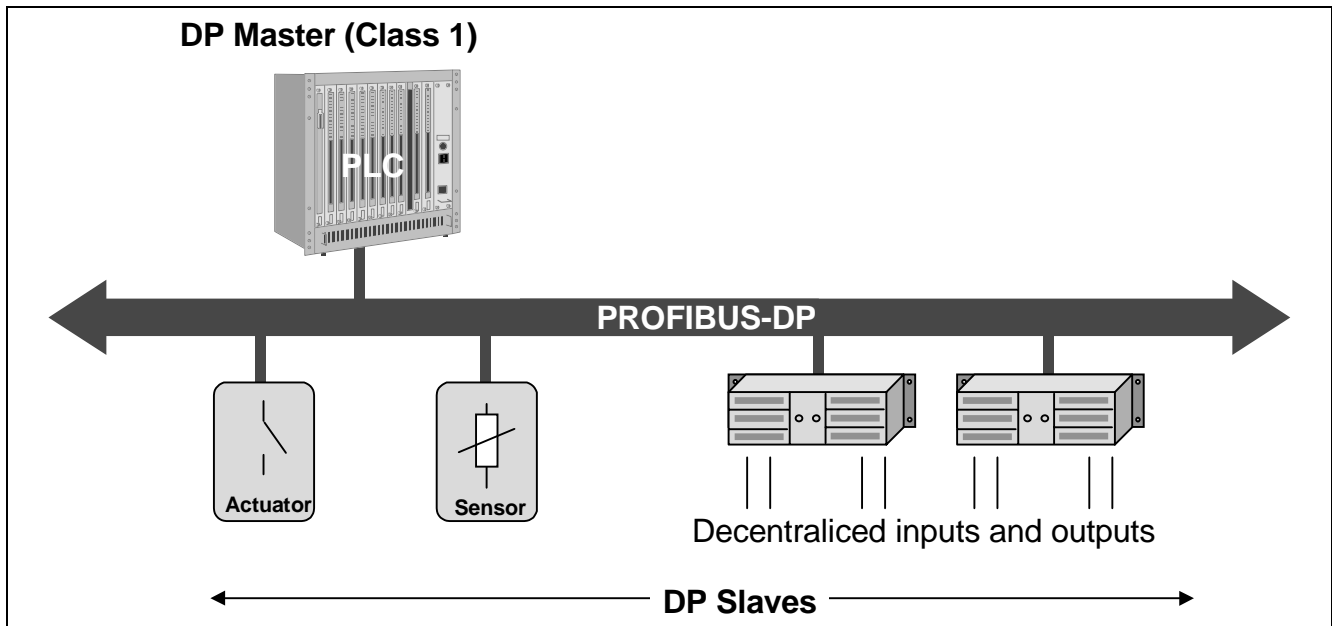

Fig. 10: DP mono-master system

or operating devices. They are used for commissioning and for maintenance and diagnostics, in order to configure the connected devices, evaluate measured values and parameters, and request the device status.

Slave

A slave is a peripheral device (I/O devices, drives, HMI, valves, measuring transducers) which collects input information and sends output information to the peripherals. There are also devices which supply only input or only output information.

The amount of input and output information depends on the device type. A maximum of 246 bytes of input data and 246 bytes of output data is permitted.

In **mono-master systems** only one master is active on the bus during operation of the bus system. Figure 10 shows the system configuration of a mono-master system. The programmable controller is the central control component. The slaves are decentrally linked to the PLC via the transmission medium. Mono-master systems attain the shortest bus cycle time.

In **multi-master configurations** several masters are connected to one bus. These masters represent either independent subsystems, each consisting of one DPM1 master and its assigned slaves, or additional configuration and diagnostic devices. The input and output images of the slaves can be read by all DP masters. However, only one DP master (i.e., the DPM1 assigned during configuration) may write-access the outputs.

4.1.3 System behavior

The DP specification includes a detailed description of system behavior to ensure device interchangeability. System behavior is determined primarily by the operating status of the DPM1.

DPM1 can be controlled either locally or via the bus by the configuration device. There are three main states:

- **Stop**
In this state, no data transmission occurs between the DPM1 and the slaves.
- **Clear**
In this state, the DPM1 reads the input information of the slaves and holds the outputs in fail-safe status.
- **Operate**
In this state, the DPM1 is in the data transfer phase. In cyclic data communication, inputs of the slaves are read, and output information is written to the slaves.

The DPM1 cyclically sends its status to all slaves assigned to it using a multicast command at a configurable time interval.

The system reaction to an error during the data transfer phase of the DPM1 (such as failure of a slave) is determined by the "auto-clear" configuration parameter.

If this parameter is set to true, the DPM1 switches the outputs of all assigned slaves to fail-safe state as soon as a slave is no longer ready for user data

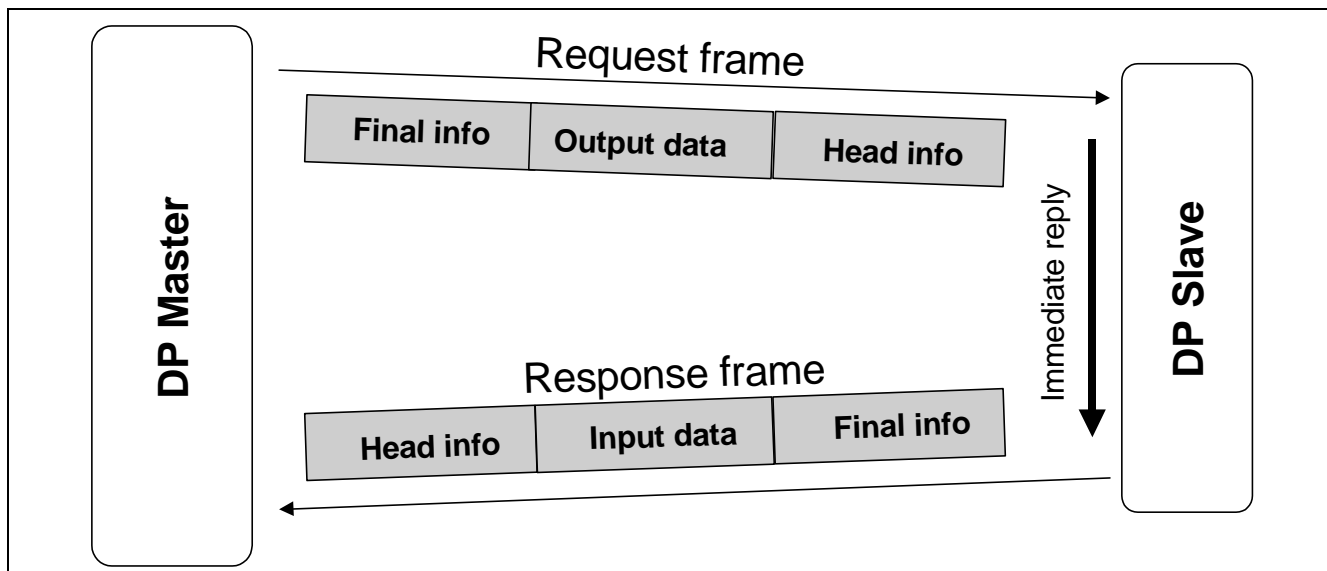

Fig. 11: Cyclic user data transmission in DP

transmission. The DPM1 then changes to the Clear state.

If this parameter is false, the DPM1 remains in operate state even when a fault occurs, and the user can specify the system reaction.

4.1.4 Cyclic Data Transmission between the DPM1 and the Slaves

Data transmission between the DPM1 and the slaves assigned to it is executed automatically by the DPM1 in a defined, recurring order. When configuring the bus system, the user defines the assignment of a slave to the DPM1. He also defines which slaves are to be included in, or excluded from, the cyclic user data communication.

Data transmission between the DPM1 and the slaves is divided into three phases: parameterization, configuration and data transfer. Before a DP slave enters the data transfer phase, in the parameterization and configuration phase it is checked, whether the planned configuration matches the actual device configuration. In the course of this check, the device type, format and length information as well as the number of inputs and outputs must agree. These tests provide the user reliable protection against parameterization errors. In addition to the user data transfer, which is executed automatically by the DPM1, new parameterization data can be sent to the slaves at the request of the user.

4.1.5 Sync and Freeze Mode

In addition to station-related user data transfer, which is executed automatically by the DPM1, the master can send control commands to a single

slave, a group of slaves or all slaves simultaneously. These control commands are transmitted as multicast commands. They permit use of sync and freeze modes for event-controlled synchronization of the slaves.

The slaves begin **sync mode** when they receive a sync command from their assigned master.

The outputs of all addressed slaves are then frozen in their current state. During subsequent user data transmissions, the output data are stored at the slaves, but the output states remain unchanged. The stored output data are not sent to the outputs until the next sync command is received. Sync mode is concluded with the unsync command.

Similarly, a freeze control command causes the addressed slaves to assume **freeze mode**. In this operating mode, the states of the inputs are frozen at the current value. Input data are not updated again until the master sends the next freeze command. Freeze mode is concluded with the unfreeze command.

4.1.6 Protection Mechanisms

Security and reliability make it necessary to provide DP with effective protection functions against parameterization errors or failure of the transmission equipment. To achieve this, monitoring mechanisms are implemented in the DP master and in the slaves in the form of time monitoring. The monitoring interval is defined during configuration.

At the DP master

The DPM1 monitors data transmission of the slaves with the Data_Control_Timer. A separate control timer is used for each slave. The time monitoring is tripped when correct data transmission does not occur within the monitoring interval. The user is informed when this happens. If the automatic error reaction (Auto_Clear = True) has been enabled, the DPM1 exits its OPERATE state, switches the outputs of all assigned slaves to fail-safe status and changes to the CLEAR status.

At the slave

The slave uses the watchdog control to detect failures of the master or the transmission line. If no data communication with the master occurs within the watchdog control interval, the slave automatically switches its outputs to the fail-safe status.

In addition, access protection is required for the inputs and outputs of the slaves operating in multi-master systems. This ensures that only the authorized master has direct access. For all other masters, the slaves offer an image of their inputs and outputs which can be read from any master, even without access rights.

4.2 Extended DP Functions

The extended DP functions make it possible to transmit acyclic read and write functions as well as alarms between master and slaves parallel and independent of cyclic user data communication. This allows the user to use for example an engineering tool (DPM2), to optimize the device parameters of the connected field devices (slaves) or read out the device status without disturbing system operation.

With these extended functions, DP meets the requirements of even complex devices which often have to be parameterized during operation. Nowadays, the extended DP functions are mainly used for the online operation of the PA field devices by means of engineering tools. Transmission of the acyclic required data is performed with a lower priority parallel to the high-speed cyclic user data transfer. The master requires some additional time to carry out the acyclic communication services. This must be taken into account in the parameterization of the overall system. To achieve this, the parameterization tool usually increases the token circulation time somewhat in order to give the master a chance to carry out not only cyclic data transmission, but also acyclic communication tasks.

These extended functions are optional. They are compatible with basic DP functions. Existing devices which do not want or need to use the new functions can continue to be used since the extended functions are only supplements to already existing basic functions. The DP extensions are specified in the technical PROFIBUS guideline No. 2.082.

4.2.1 Addressing with Slot and Index

To address the data, PROFIBUS assumes that the slaves are built up as physical building blocks, or can be structured internally in logical function units, so-called modules. This model is also used in the basic DP functions for cyclic data transmission where each module has a constant number of input and/or output bytes which are transmitted in a fixed position in the user data telegram. The addressing procedure is based on identifiers which characterize the type of a module as input, output or a combination of both. All identifiers together give the configuration of a slave, which is also checked by the DPM1 when the system starts up.

The new acyclic services are also based on this model. All data blocks enabled for read or write accesses are also considered as belonging to the modules. These blocks can be addressed by slot number and index. The slot number addresses the module, and the index addresses data blocks belonging to a module. Each data block can have a size of up to 244 bytes, see Fig. 12. With modular devices, the slot number is assigned to the modules. Beginning with 1, the modules are numbered consecutively in increasing order. Slot number 0 is provided for the device itself. Compact devices are treated as one unit of virtual modules. Addressing with slot number and index is also used here.

Using the length specification in the read or write request, it is also possible to read or write parts of a data block. If access to the data block was successful, the slave responds with a positive read or write response. If not successful, the slave gives a negative response in which the problem is classified.

4.2.2 Acyclic Data Transmission between the DPM1 and the Slaves

The following functions are available for acyclic data communication between the central automation system (DPM1) and the slaves:

MSAC1_Read:

The master reads a data block from the slave

MSAC1_Write:

The master writes a data block to the slave

MSAC1_Alarm:

Transmission of an alarm from the slave to the master. The receipt of an alarm is explicitly acknowledged by the master. Only after the alarm acknowledgement has been received, the slave is able to send a new alarm message. This means that alarms can never be overwritten.

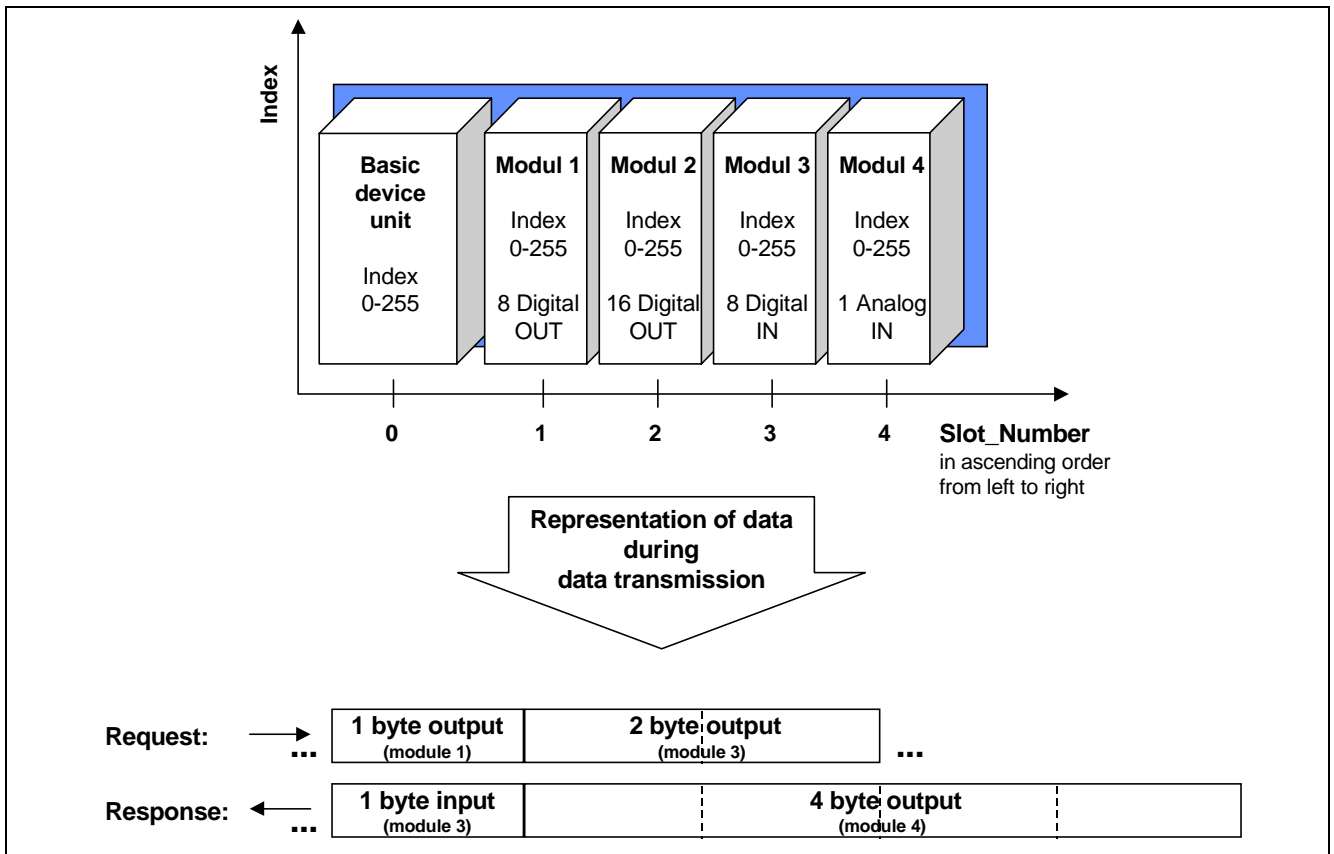

Fig. 12: Addressing in the acyclic read and write services of DP

MSAC1_Alarm_Acknowledge:

The master acknowledges the receipt of an alarm message to the assigned slave

MSAC1_Status:

Transmission of a status message from the slave to the master. The receipt of the status message is not acknowledged. Status messages can therefore be overwritten.

Data is transferred connection-oriented via an MSAC1 connection. This connection is established by the DPM1. It is very closely linked to the connection for cyclic data communication between the DPM1 and the slaves and can only be used by the master that has also parameterized and configured the slave in question.

4.2.3 Acyclic Data Transmission between DPM2 and the Slaves

The following functions are available for acyclic data communication between the engineering and operator tools (DPM2) and the slaves:

MSAC2_Initiate and MSAC2_Abort

Establishment and termination of a connection for acyclic data communication between the DPM2 and the slave.

MSAC2_Read:

The master reads a data block from the slave

MSAC2_Write:

The master writes a data block to the slave

MSAC2_Data_Transport:

With this service, the master can write data acyclically to the slave and if required also read data from the slave in the same service cycle. The meaning of the data is application-specific and defined in profiles.

The communication is performed connection-oriented. The connection is called MSAC_C2. The connection is established before the beginning of acyclic data communication by the DPM2 with the MSAC2_Initiate service. After this, the connection is available for the MSAC2_Read, MSAC2_Write and MSAC2_Data_Transport services. When a connection is no longer needed, it is disconnected by the master with the MSAC2_Abort service. In general it is possible for a slave to maintain several active MSAC2 connections at the same time. The number of connections that can be kept active at the same time is limited by the resources available in the slave and varies depending on the device type. Acyclic data transmission is effected in a predefined sequence, which will be described in the following with the help of the MSAC2_Read service.

First the master sends an MSAC2_Read request to the slave; in this request the required data are addressed using the slot number and index. After this request has been received, the slave has the opportunity to make the required data available. The master now sends regular poll telegrams to collect the requested data from the slave. The slave answers the poll telegrams of the master with a brief acknowledgement without data until it has processed the data. The next poll request by the master is then answered with an MSAC2_Read response, with which the read data are transmitted to the master. Data transmission is time-monitored.

The monitoring interval is specified with the DDLM_Initiate service when the connection is established. If the connection monitor detects a fault, the connection is automatically disconnected on both the master and the slave side. The connection can then be established again or used by another partner. Service access points 40 to 48 on the slave and service point 50 on the DPM2 are reserved for the MSAC_C2 connection.

5. FMS Communication Profile

The FMS Communication Profile is designed for communication at cell level. At this level, programmable controllers (PLCs and PCs) communicate primarily with each other. In this application area a high degree of functionality is more important than fast system reaction times.

The FMS application layer (7) consists of the following parts:

- The **Fieldbus Message Specification (FMS)** and
- the **Lower Layer Interface (LLI)**

The PROFIBUS-FMS communication model permits distributed application processes to be unified into a common process by using communication relationships. That portion of an application process in a field device which can be reached via communication is called a virtual field device (VFD). Figure 13 shows the relationship between the real field device and the virtual field device. In this example, only certain variables (i.e., number of units, rate of failure and downtime) are part of the virtual field device and can be read or written via the two communication relationships. The variables Required Value and Recipe are not available with FMS.

All **communication objects** of an FMS device are entered in the object dictionary (OD). The object dictionary contains description, structure and data type, as well as the relationship between the internal device addresses of the communication objects and their designation on the bus (index/name).

Static communication objects are entered in the static object dictionary. They are configured once and cannot be modified during operation. FMS recognizes five types of communication objects:

- **Simple Variable**
- **Array** (series of simple variables of the same type)

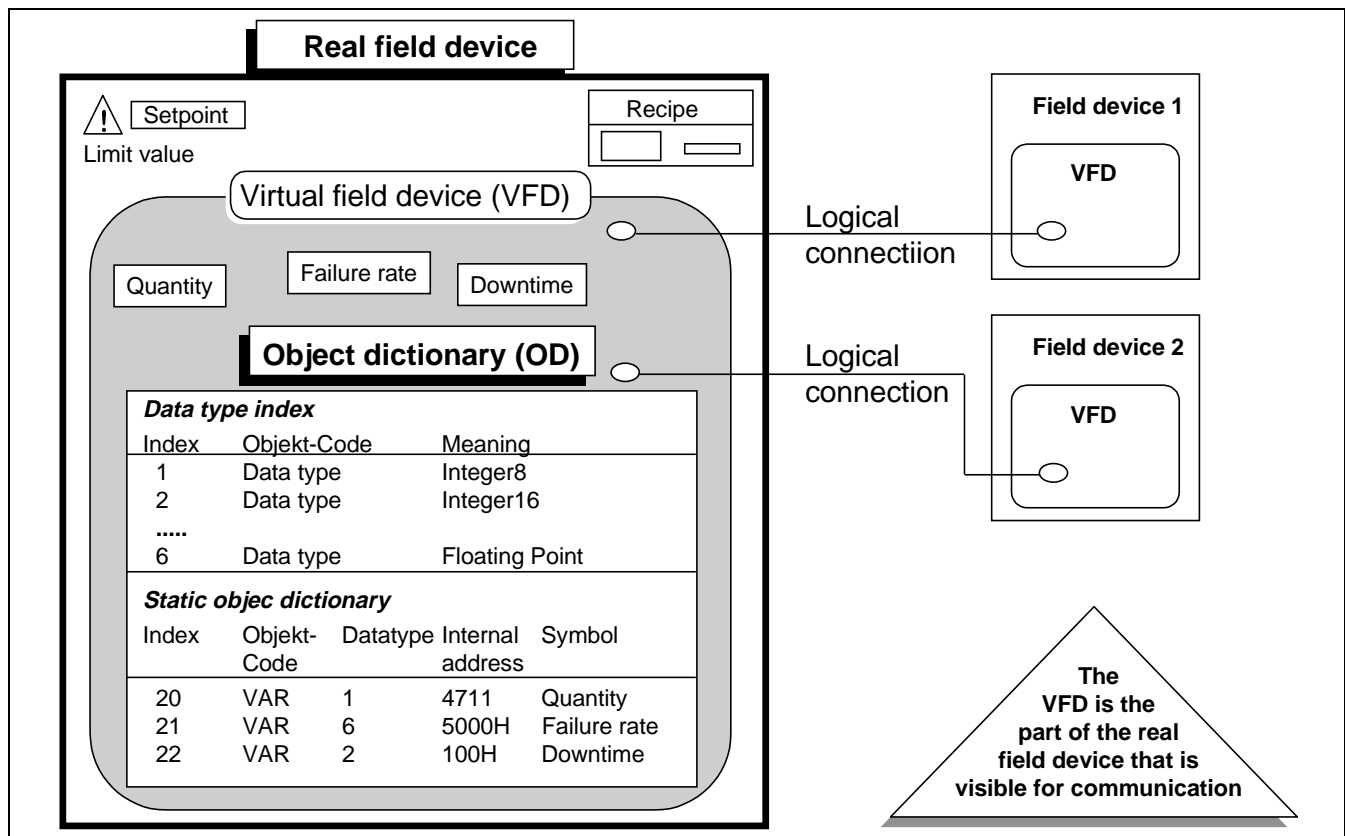

Fig. 13: Virtual field device (VFD) with object dictionary (OD)

- **Record** (series of simple variables of different types)
- **Domain**
- **Event** (event message)

Dynamic communication objects are entered in the dynamic section of the object dictionary. These can be modified during operation.

Logical addressing is the preferred method of addressing for the objects. Accessing is performed with a short address (the index) which is a number of type Unsigned16. Each object has a unique index. An additional option is to address the objects by name.

Communication objects can also be protected from unauthorized access through **access protection**, or the permitted services for accessing an object (e.g. read only) can be restricted.

5.1 FMS Services

FMS services are a subset of the MMS services (MMS = Manufacturing Message Specification, ISO 9506) which have been optimized for field bus applications and which have been expanded by functions for communication object administration and network management. Figure 14 provides an overview of the available PROFIBUS FMS services.

Confirmed services can only be used for connection-oriented communication relationships. The execution of a service is shown in Fig. 15.

Unconfirmed services can also be used on connectionless communication relationships (broadcast and multicast). They can be transmitted with high or low priority.

FMS services are divided into the following groups:

- **Context Management** services are for establishing and terminating logical connections.
- **Variable Access** services are used to access variables, records, arrays or variable lists.
- **Domain Management** services are used to transmit large memory areas. The data must be divided into segments by the user.
- **Program Invocation Management** services are used for program control.
- **Event Management** services are used to transmit alarm messages. These messages can also be sent as broadcast or multicast transmissions.
- **VFD Support** services are used for identification and status polling. They can also be sent spontaneously at the request of a device as multicast or broadcast transmissions.
- **OD Management** services are used for read and write access to the object dictionary.

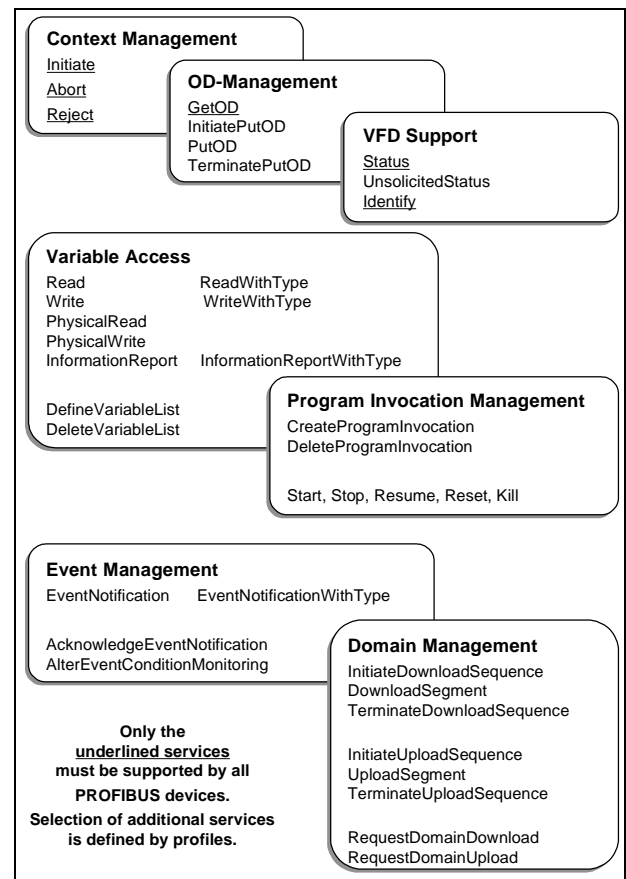

Fig. 14: Overview of FMS services

5.2 Lower Layer Interface (LLI)

The mapping of layer 7 to layer 2 is handled by LLI. Tasks include flow control and connection monitoring. The user communicates with the other processes via logical channels called **communication relationships**. The LLI provides various types of communication relationships for execution of the FMS and management services. The communication relationships have different connection capabilities (i.e., monitoring, transmission and demands on the communication partners).

Connection-oriented communication relationships represent a logical peer-to-peer connection between two application processes. The connection must first be established with an Initiate service before it can be used for data transmission. After being successfully established, the connection is protected against unauthorized access and is available for data transmission. When an established connection is no longer needed, it can be disconnected with the Abort service. The LLI permits time-controlled connection monitoring for connection-oriented communication relationships.

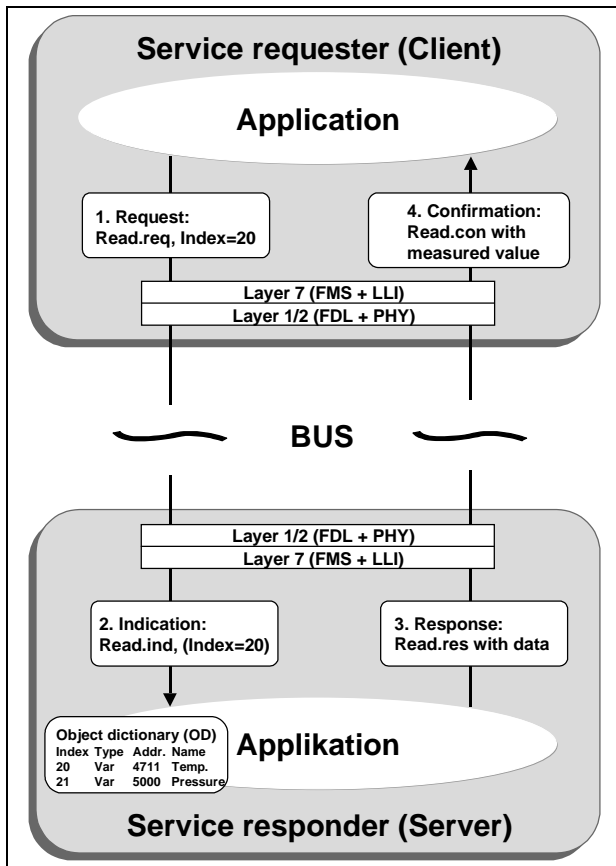

Fig. 15: Sequence of a confirmed FMS service

The connection attributes "open" and "defined" are another characteristic feature of connection-oriented communication relationships.

In **defined connections** the communication partner is specified during configuration. In **open connections** the communication partner is not specified until the connection establishment phase.

Connectionless communication relationships permit one device to communicate simultaneously with several stations using unconfirmed services. In **broadcast** communication relationships, an unconfirmed FMS service is simultaneously sent to all other stations. In **multicast** communication relationships, an unconfirmed FMS service is simultaneously sent to a predefined group of stations.

All communication relationships of an FMS device are entered in the CRL. For simple devices the list is predefined by the manufacturer. In the case of complex devices, the CRL is user-configured. Each communication relationship is addressed by a local short designation, the **communication reference (CREF)**. From the point of view of the bus, a CREF is defined by a station address, layer 2 service access point and LLI service access point. The CRL contains the assignment between CREF and the layer 2 as well as LLI address. In addition, the CRL also specifies which FMS services are supported, telegram lengths, etc., for each CREF.

5.3 Network Management

In addition to the FMS services, network management functions (**Fieldbus Management Layer 7 = FMA7**) are available. The FMA7 functions are optional and allow central configuration. They can be initiated locally or remotely.

Context Management can be used to establish and disconnect an FMA7 connection.

Configuration Management can be used to access CRLs, variables, statistic counters and the parameters of layers 1/2. It can also be used for identification and registration of bus stations.

Fault Management can be used to indicate faults/events and to reset the devices.

A uniform access for the configuration devices is obtained by specification of the default management connection. One default management connection must be entered with CREF = 1 in the CRL for every device which supports FMA7 services as a responder.

6. Application Profiles

PROFIBUS Application Profiles describe the use of PROFIBUS Communication and Physical Profiles for a certain range of applications (process automation, building automation) or for certain device types (encoders, drives).

6.1 Process Automation (PA)

The use of PROFIBUS in typical devices and applications in process automation is defined by the PA profile. The profile can be obtained from the PROFIBUS User Organization under order number 3.042. It is based on the DP Communication Profile, and depending on the field of application, IEC 1158-2, RS-485 or optical fibers are used as transmission technology. The PA profile defines the device parameters and the device behavior of typical field devices such as measuring transducers or positioners independent of the manufacturer, thus facilitating device interchangeability and vendor independent operation. The description of the functions and device behavior is based on the internationally recognized Function Block model. The definitions and options of the PA application profile, make PROFIBUS suitable as a substitute for analog signal transmission with 4 ... 20 mA or Hart.

PROFIBUS also permits measuring and closed-loop control in process engineering applications via a simple two-wire cable. PROFIBUS permits maintenance and connection/disconnection of devices during operation even in hazardous areas. The PROFIBUS PA profile has been developed in close cooperation with users in the processing industry

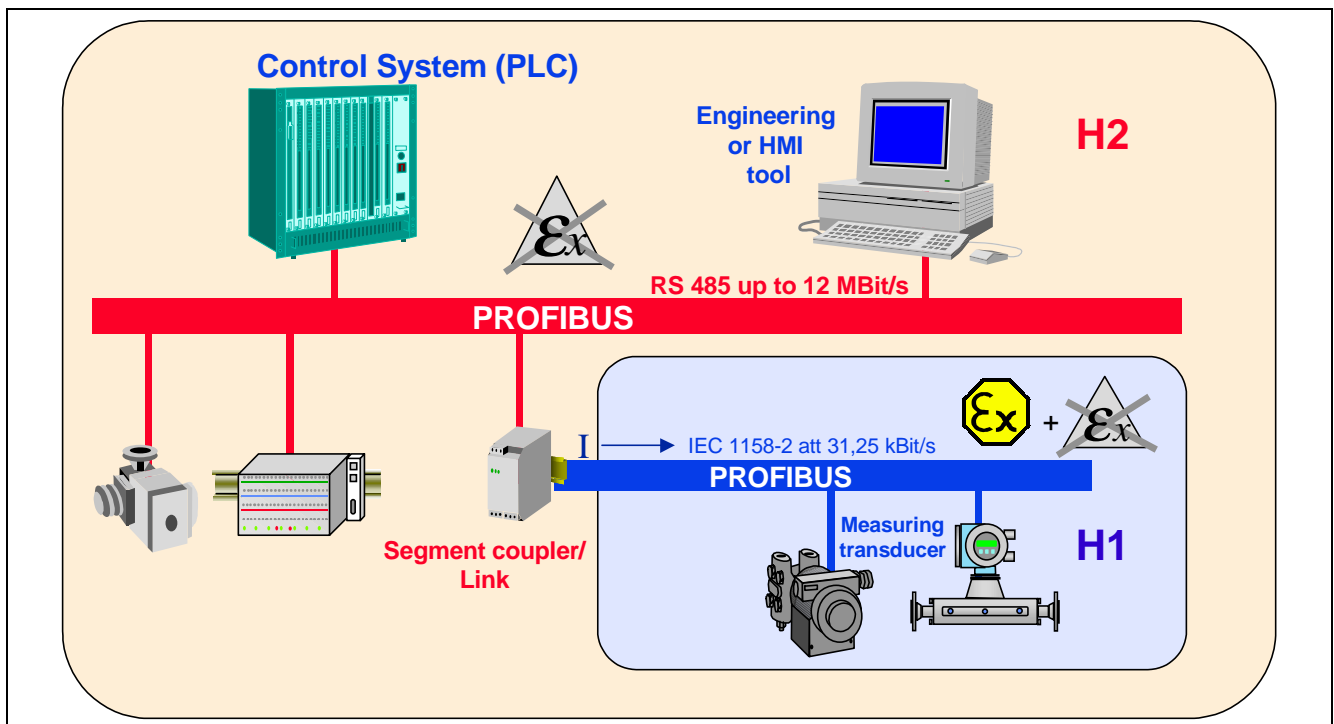

Fig. 16: Typical system configuration in process automation

(NAMUR) and meets the special requirements of this application area:

- Standardized application profiles for process automation and interchangeability of field devices from different vendors
- Addition and removal of bus stations even in intrinsically safe areas without influencing other stations
- Bus supply of measuring transducers using two-wire technology according to IEC 1158-2.
- Use is also possible in potentially explosive areas with protection types “intrinsically safe” (EEx ia/ib) or “encapsulation” (EEx d).

6.1.1 Communication Aspects

The use of PROFIBUS in process engineering systems achieves cost savings of more than 40% in planning, cabling, commissioning and maintenance and offers a significant increase in functionality and security. Figure 17 shows the differences between the wiring of a conventional 4 to 20 mA system and a system based on PROFIBUS.

The field devices in the hazardous area are connected via PROFIBUS using IEC 1158-2 transmission technology. The IEC 1158-2 technology allows the transmission of data and energy for the field device using only two wires. The transition to the non-hazardous area, where PROFIBUS is used with RS-485 technology, is effected by a segment coupler or link. Unlike conventional wiring, where a separate line has to be laid for each signal from the measuring point to the I/O module of the process

control system (DCS), with PROFIBUS the data of several devices are transmitted through one common cable. While a separate power supply (explosion-proof if necessary), is required for each signal with conventional wiring, the segment coupler or link carries out this function commonly for many devices in a PROFIBUS network. Depending on the explosion requirements and energy consumption of the devices, 9 (EEx ia/ib) up to 32 (non-ex) measuring transducers can be connected to one segment coupler/link. This saves not only on wiring, but also on the I/O modules of the DCS. Because these are replaced by the PROFIBUS interface. Since several measuring transducers can be supplied with operating energy from a single supply unit, with PROFIBUS all isolators and barriers can be dropped.

The measured values and status of the PA field devices are transmitted cyclically with high priority between the DCS (DPM1) and the measuring transducers using the fast DP basic functions. This ensures that the current measured value and its associated status are always up to date and available in the automation system (DPM1). On the other hand, the device parameters for visualization, operation, maintenance and diagnostics are transmitted by the engineering tool (DPM2) with the low-priority acyclic DP functions via a C2 connection.

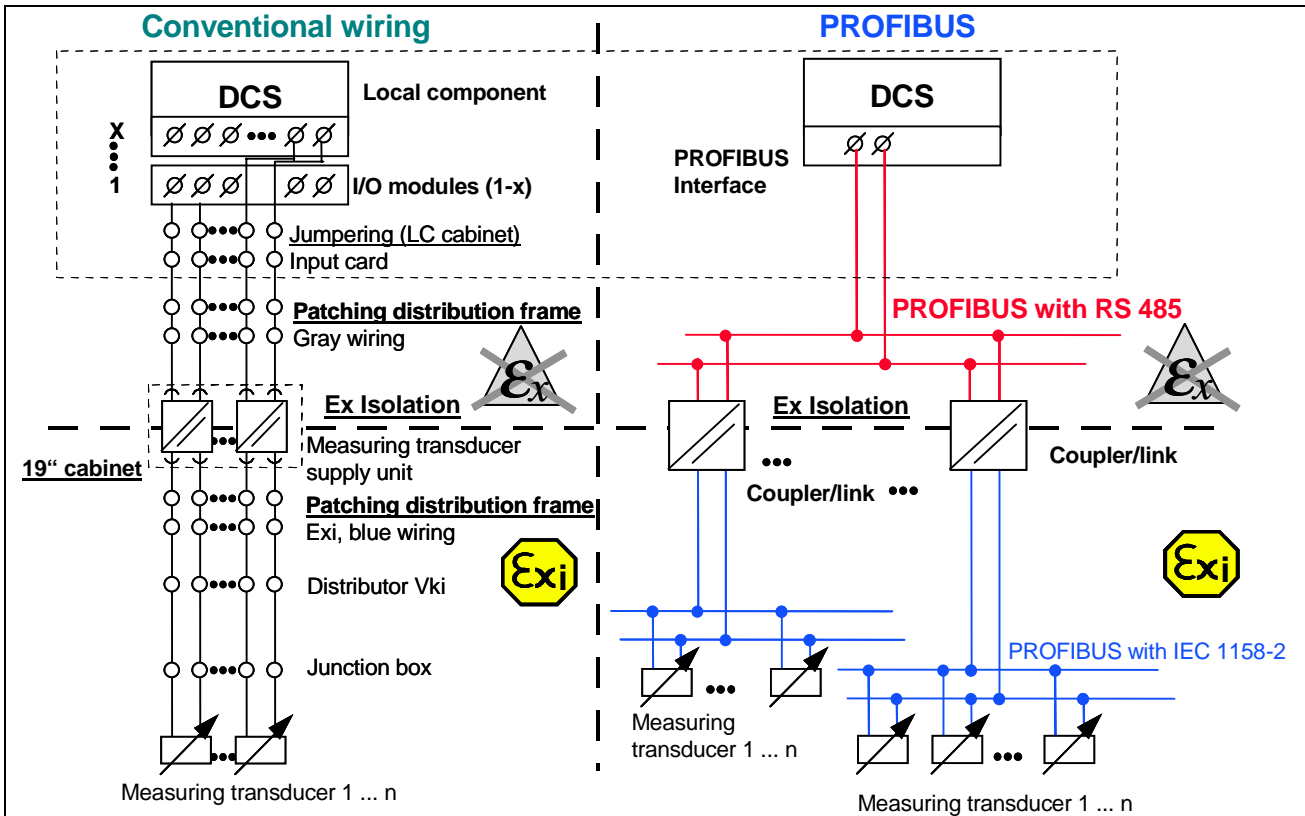

Fig. 17: Comparison of conventional wiring and PROFIBUS

6.1.2 Application aspects

Besides communication-relevant definitions, the PA profile also contains application-relevant definitions, such as data type and unit of the transmitted measured value, as well as the significance of the associated status value. Specifications for the unit and meaning of the device parameters, such as upper/lower measuring range limit, are vendor-independent. To support commissioning, the simu-

lation of values in the measuring transducer is also possible.

Here the user can enter a fictitious measured value using the engineering tool; this is then transmitted from the measuring transducer to the process control system instead of the real measured value. This facilitates the simulation of critical plant states and supports the commissioning personnel during step-by-step commissioning of the plant.

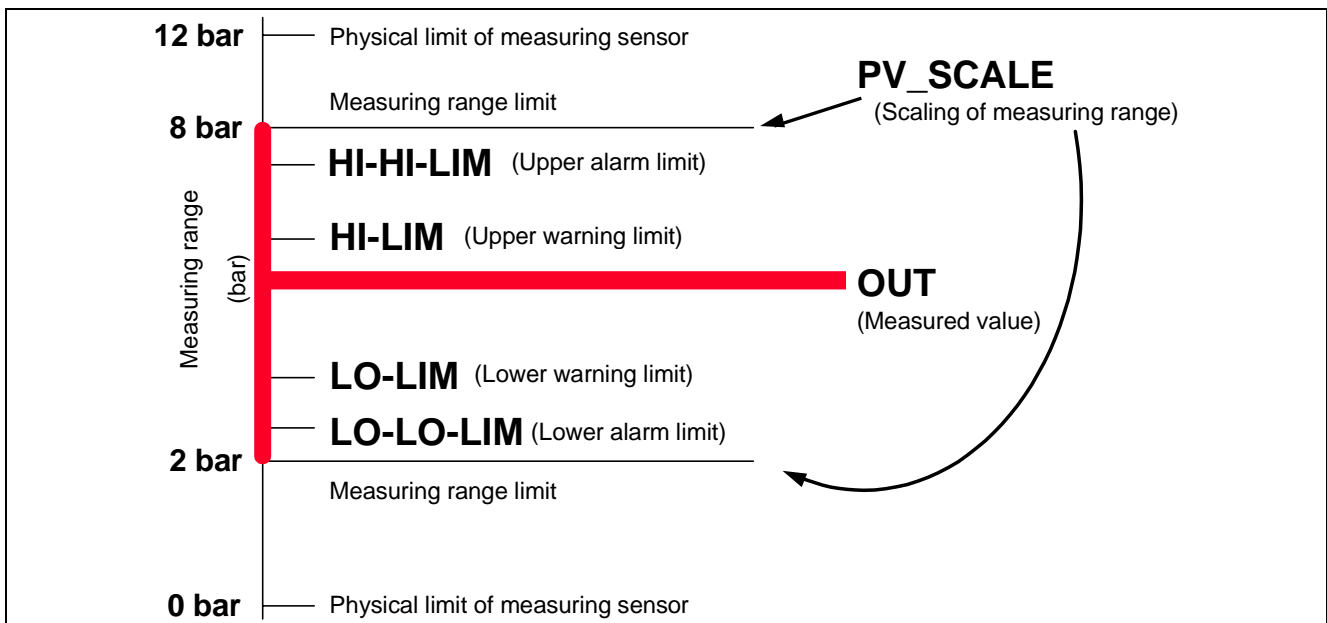

Fig. 18: Illustration of the parameters in the PROFIBUS PA profile

Parameter	Read	Write	Function
OUT	●		Current measured value of the process variable and the status
PV_SCALE	●	●	Scaling of the process variables of the lower and upper measuring range limit, code for units and number of digits after the decimal point
PV_FTIME	●	●	Rise time of the function block output in sec
ALARM_HYS	●	●	Hysteresis of the alarm functions as % of the measuring range
HI_HI_LIM	●	●	Upper alarm limit: If exceeded, alarm and status bit are set to 1
HI_LIM	●	●	Upper warning limit: If exceeded, warning and status bit are set to 1
LO_LIM	●	●	Lower warning limit: If not reached, warning and status bit are set to 1
LO_LO_LIM	●	●	Lower alarm limit: If not reached, alarm and status bit are set to 1
HI_HI_ALM	●		Status of the upper alarm limit with time stamp
HI_ALM	●		Status of the upper warning limit with time stamp
LO_ALM	●		Status of the lower warning limit with time stamp
LO_LO_ALM	●		Status of the lower alarm limit with time stamp

Table 10: Parameters of the analog input function block (AI)

Device behavior is described by specifying standardized variables with which the properties of the measuring transducers are described in detail. Fig. 18 shows the principle of a pressure transmitter, which is described with the "Analog Input" function block.

The PA profile consists of a general data sheet containing the definitions applicable for all device types, and device data sheets containing specific information for the respective device type. The profile is suitable for the description of devices with only one measured variable (single variable) as well as for multifunctional devices with several measured variables (multi-variable). The current PA profile (Version 3.0) defines the device data sheets for all common measuring transducers:

- Pressure and differential pressure
- Level, temperature, flow rate
- Analog and digital inputs and outputs
- Valves, positioners
- Analyzers

6.1.3 PA Function Blocks

The PA profile supports interchangeability and interoperability of PA field devices from different vendors. The profile uses the internationally recognized function block model to describe the device functions and parameters. The function blocks represent different user functions, such as analog input or analog output. In addition to the application-

specific function blocks, two function blocks are available for device-specific characteristics (physical block and transducer block). The input and output parameters of the function blocks can be connected via the bus and linked to a process engineering application.

Physical Block

Contains general device information such as device name, manufacturer, version, serial number

Transducer Block

Contains application-specific data such as correction parameters

Analog Input Block (AI)

Provides the value measured by the sensor, with status and scaling

Analog Output Block (AO)

Provides the analog output with the output value specified by the control system

Digital Input (DI)

Provides the control system with the value of the digital input

Digital Output (DO)

Provides the digital output with the value specified by the control system

An application contains several function blocks. The function blocks are integrated into the field devices

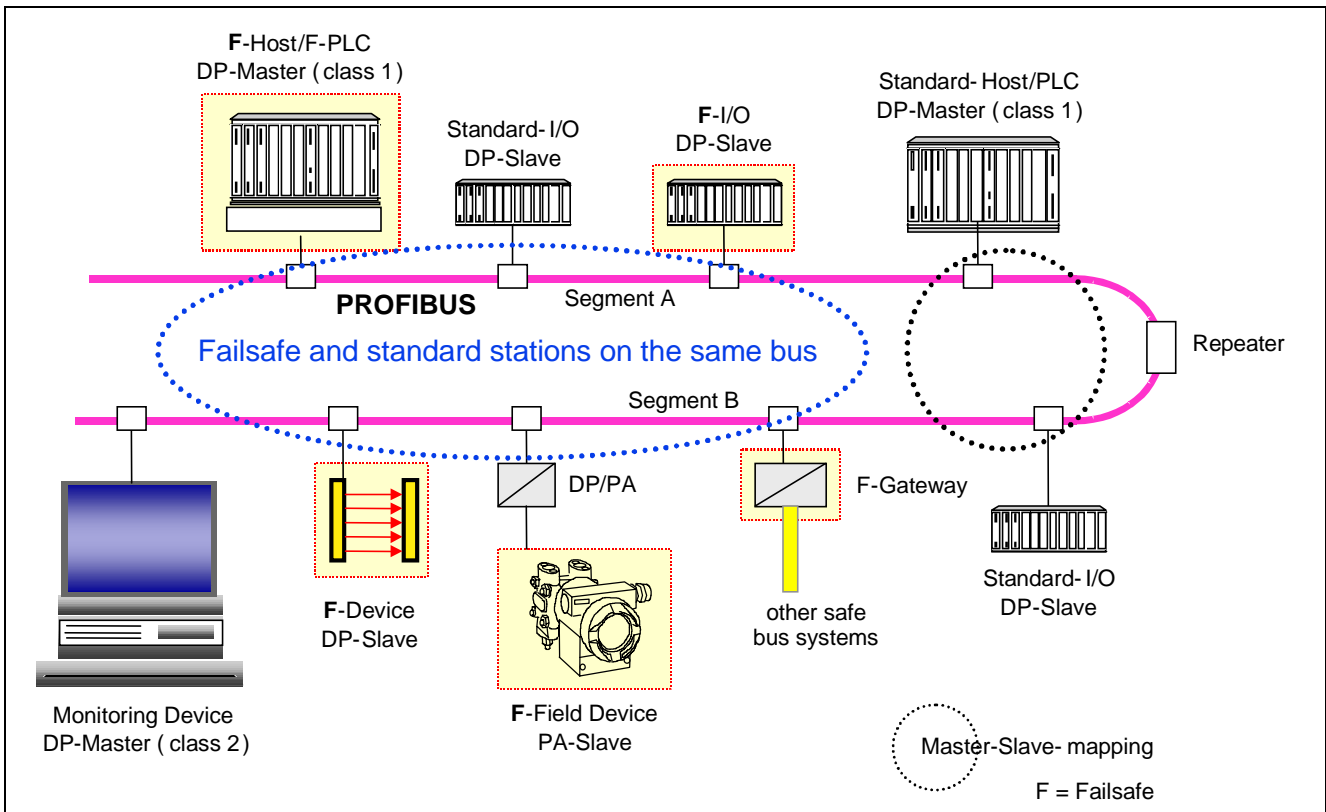

Fig. 19: With the ProfiSafe profile, failsafe devices can communicate via PROFIBUS

by the device manufacturers and can be accessed via communication as well as via the engineering tools.

6.2 Failsafe Applications

The PROFISafe profile (order number 3.092) defines how failsafe devices (emergency stop push-button, light grids, interlocks) are connected to the programmable controllers via PROFIBUS. This means that the advantages of open bus communication with PROFIBUS can also be used in this special area where, until now, almost all devices were wired conventionally.

While developing the concept for the safe transmission of data via PROFIBUS, the focus was not only on the reduction of wiring costs, but also the wide range of applications in the manufacturing and processing industry. As a result, devices with PROFISafe profile can be operated without restrictions and in harmonious coexistence with standard devices using one and the same cable. ProfiSafe is based on the DP Communication Profile and can be operated with RS-485, fiber optics or IEC 1158-2 technology.

At the same time, very fast reaction times can be achieved with DP in the manufacturing sector, and in the processing sector no additional power consumption is needed for PA field devices. ProfiSafe is a single-channel software solution that does not require any further bus cables.

ProfiSafe takes account of all known possible errors that can occur during serial bus communication (repetition, loss, insertion, incorrect sequence, delay, masquerade, corrupted process data and erroneous addressing) and defines further security mechanisms which extend beyond the standard error detection and elimination mechanisms of the PROFIBUS bus access protocol.

Through skilful selection and combination of the available recovery measures, such as consecutive numbering, time monitoring with acknowledgement, source-target identification and CRC control, as well as a patented "SIL Monitor", it was possible to achieve the required fail probability class up to SIL3, or AK6, or category 4. Furthermore, the PROFISafe profile has been given extra weight by favorable reports from TÜV and BIA. For the manufacturers of failsafe devices there is a special software driver available, that implements all definitions of the PROFISafe profile.

6.3 Building automation

This profile (order number 3.011) is dedicated to a specific branch and serves as basis for many public procurements in building automation. On the basis of the FMS Communication Profile it defines how the monitoring, control, regulation, operation, alarm handling and archiving of building automation systems is to be effected.

6.4 Application Profiles for Special Device Types

On the basis of the DP Communication Profile, application profiles are defined for the following device types:

NC/RC (3.052):

This profile describes how handling and assembly robots are controlled. Flow charts show the motion and program control of the robots from the point of view of the higher-level automation system.

Encoders (3.062):

This profile describes the linking to DP of rotary encoders, angle encoders and linear encoders with single-turn or multi-turn resolution. Two classes of devices define basic functions and additional functions such as scaling, alarm handling and diagnostics.

Variable-speed drives (3.072)

The profile specifies how the drives are to be parameterized and how the setpoints and actual values are to be transmitted. This enables interchangeability of drives from different vendors. The profile contains specifications for speed control and positioning modes. It specifies the basic drive functions while leaving sufficient freedom for application-specific extensions and further developments.

Human machine interface (3.082):

This profile for the human machine interface (HMI) specifies the linking of these devices via DP to higher-level automation components. The profile uses the extended DP functions for communication.

7. Device Engineering

PROFIBUS devices have different performance characteristics. Features differ in regard to available functionality (i.e., number of I/O signals and diagnostic messages) or possible bus parameters such as baud rate and time monitoring. These parameters vary individually for each device type and vendor and are usually documented in the technical manual. In order to achieve a simple Plug and Play configuration for PROFIBUS, electronic device data sheets (GSD files) were defined for the communication features of the devices.

Powerful configuration tools are available for the configuration of a PROFIBUS network. Based on the GSD files, these allow easy configuration of PROFIBUS networks with devices from different manufacturers.

7.1 GSD Files

The characteristic communication features of a PROFIBUS device are defined in the form of an electronic device data sheet (GSD). GSD files must be provided by the manufacturer for all PROFIBUS devices.

GSD files expand open communication up to operator control level. GSD files can be loaded during configuration using any modern configuration tool. This means that integration of devices from different manufacturers into the PROFIBUS system is simple and user-friendly.

The GSD files provide a clear and comprehensive description of the characteristics of a device type in a precisely defined format. GSD files are prepared individually by the vendor for each type of device and made available to the user in the form of a file. The defined file format permits the configuration system to simply read in the GSD files of any PROFIBUS device and automatically use this information when configuring the bus system. Project engineers are spared the time-consuming job of looking up this information in technical manuals. Even during the configuration phase, the configuration system can automatically perform checks for input errors and the consistency of data entered in relation to the overall system. The GSD file is divided into three sections:

- **General specifications**

This section contains information on vendor and device names, hardware and software release states, baud rates supported, possible time intervals for monitoring times and the signal assignment on the bus connector.

- **Master-related specifications**

This section contains all master-related parameters, such as: the maximum number of slaves that can be connected, or upload and download options. This section does not exist for slave devices.

- **Slave-related specifications**

This section contains all slave-related specifications, such as the number and type of I/O channels, specification of diagnostic texts and information on the available modules with modular devices.

In the individual sections, the parameters are separated by key words. A distinction is made between mandatory parameters (i.e., Vendor_Name) and optional parameters (i.e., Sync_Mode_supported). The definition of parameter groups allows selection of options. In addition, bit map files with the symbols of the devices can be integrated. The format of the GSD is designed for flexibility. It contains both lists (such as the baud rates supported by the

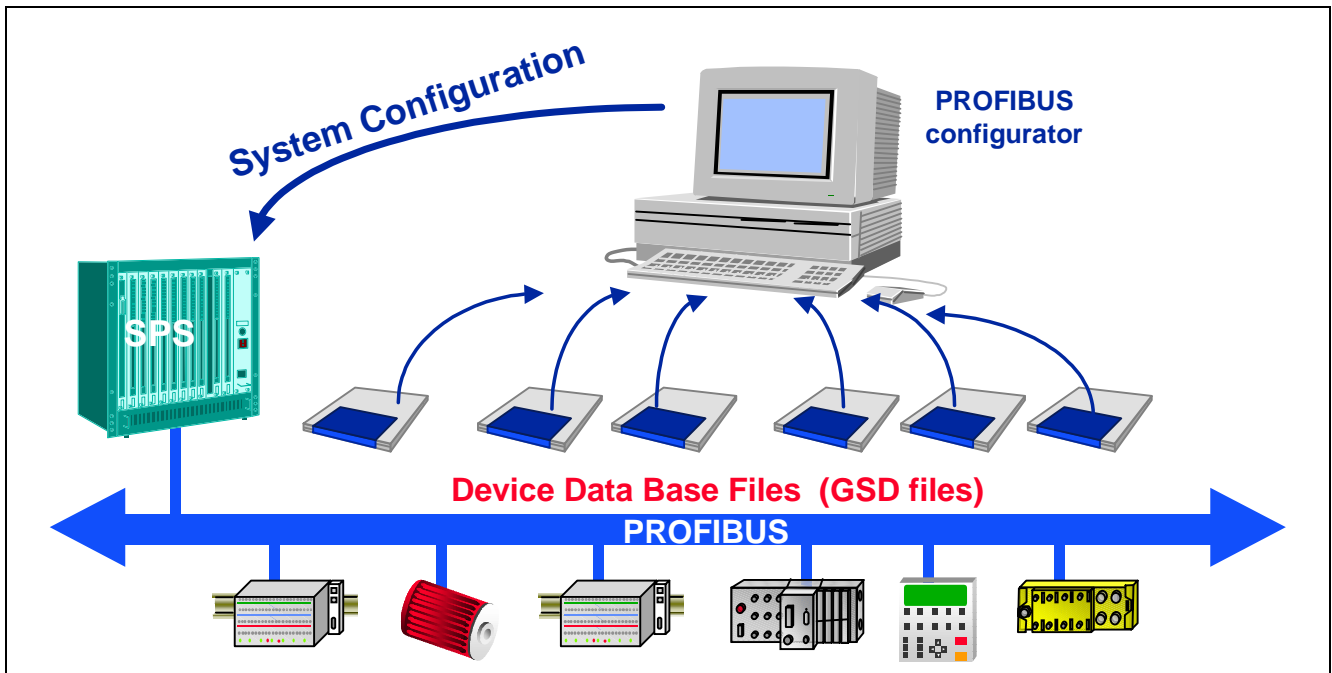

Fig. 20: GSD files permit open configuration

device) as well as space to describe the modules available in a modular device. Plain text can also be assigned to the diagnostic messages.

To support device manufacturers, the PROFIBUS homepage contains a special GSD editor and checker ready for download, which facilitate the generation and checking of GSD files. The specification of the GSD file formats is described in binding form in the following PROFIBUS guidelines:

For DP Communication No. 2.122
 For FMS Communication No. 2.102

GSD files for PROFIBUS devices, conforming to the PROFIBUS standard, can be downloaded free of charge from the GSD library on the PROFIBUS homepage (<http://www.profibus.com>)

7.2 Ident Number

Every PROFIBUS slave and every Class 1-type master must have an ID number. Masters require this number to be able to identify the types of devices connected without significant protocol overheads. The master compares the ID number of the connected devices with the ID number specified by the configuring tool in the configuration data. Transfer of user data is not started until the correct device types with the correct station addresses have been connected on the bus. This provides a high degree of security against configuration errors.

Device manufacturers must apply to the PROFIBUS User Organization for an ID number for each device type; the organization also handles administration of the ID numbers. Application forms can be ob-

tained from all regional associations or on the PROFIBUS website.

A special range of ID numbers (generic ID numbers) has been reserved for PA field devices: 9700H – 977FH. All PA field devices corresponding exactly to the definitions of the PA profile version 3.0 or higher may use ID numbers from this special ID number range. The definition of these generic ID numbers increases the interchangeability of PA field devices. The selection of the ID number to be used for the device in question depends on the type and number of existing function blocks. The ID number 9760H is reserved for PA field devices providing several different function blocks (multi-variable devices). Special conventions also apply for the designation of the GSD files for these PA field devices. These conventions are described in detail in the profile for PA field devices.

7.3 Electronic Device Description (EDD)

The Electronic Device Description (EDD) outlines the device properties of PROFIBUS field devices. The language can be used universally and allows vendor-independent descriptions for simple field devices (sensors and actuators) as well as for complex automation systems. The device descriptions are provided in electronic form by the device manufacturer for the respective devices. The EDD files are read in by the engineering tools and simplify the configuration, commissioning and maintenance of PROFIBUS systems. On one hand, the EDD files describe variables and functions of a device, and on the other hand they contain elements for operation and visualization. For the complete specification of the EDD files, refer to the PROFIBUS guideline No. 2.152.

7.4 FDT Concept

Within the framework of further technical developments, the technical committee "Process Automation" of the PROFIBUS User Organization is currently working on a concept for system-wide device engineering. The Fieldbus Device Tool (FDT) works on the basis of Microsoft COM/DCOM technology, providing a manufacturer-independent basis to access all communication and application features of a device for system-wide configuration, operation and diagnostics in future. In this concept, all parameters and options of a field device are provided by the device manufacturer in the form of a DTM (Device Type Manager). The GSD files, which already exist today, and the EDD device descriptions, are integral components of the DTM.

8. Implementation Options

A wide range of standard components (basic technology) is available for the implementation of the PROFIBUS protocol, which saves the device manufacturer time-consuming and expensive development of his own protocol software.

Complete PROFIBUS interface modules are available for low to medium quantities. These credit card-sized modules can implement the entire bus protocol. They are mounted on the master board of the device as piggy pack modules.

For large quantities, a practical solution is individual implementation on the basis of PROFIBUS protocol chips. Table 11 gives an overview of the available components. The decision in favor of a certain protocol chip depends primarily on the complexity of

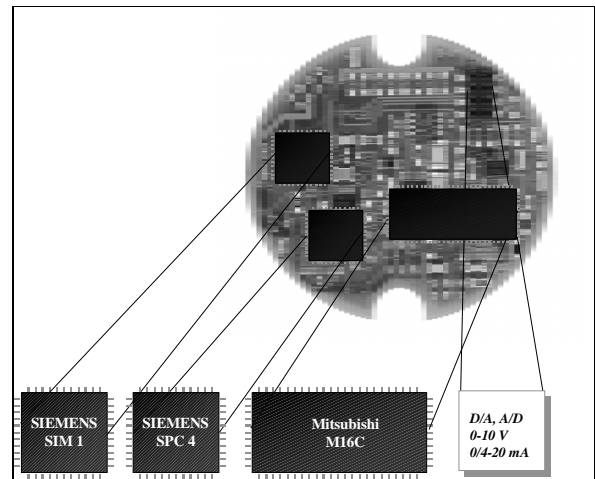

Fig. 21 Example of the implementation of a PROFIBUS slave with IEC 1158-2 Interface

the field device, the performance required and the required functionality.

For all implementation variations described, the required hardware/software components are available on the market from several manufacturers, see Table 11. A complete overview of the basic technology components is contained in the PROFIBUS Product Guide.

8.1 Implementation of Simple Slaves

For simple I/O devices, a practical solution is implementation with single-chip ASICs. All protocol functions are already integrated in the ASIC. No microprocessor or software is required. Only the bus interface driver, the quartz crystal and the

Vendor	Chip	Type	Characteristics	FMS	DP	add. micro-controller	Additional Protocol SW	Max. Baudrate
AGE	Agent-PB	Master/Slave	FPGA-based, universal protocol chip	●	●	●	●	12 MBit/s
IAM	PBM	Master	Peripheral protocol chip	●	●	●	●	3 MBit/s
M2C	IX1	Master/Slave	Single chip or peripheral protocol chip	●	●	— / ●	— / ●	3 MBit/s
Siemens	SPC4	Slave	Peripheral protocol chip	●	●	●	●	12 MBit/s
Siemens	SPC3	Slave	Peripheral protocol chip	—	●	●	●	12 MBit/s
Siemens	DPC31	Slave	Protocol chip with integrated microcontroller	—	●	— / ●	●	12 MBit/s
Siemens	ASPC2	Master	Peripheral protocol chip	●	●	●	●	12 MBit/s
Siemens	SPM2	Slave	Single Chip, 64 I/O bits directly connectable to chip	—	●	—	—	12 MBit/s
Siemens	LSPM2	Slave	Low Cost, Single Chip, 32 I/O bits directly connectable to chip	—	●	—	—	12 MBit/s
PROFICHIP	VPC3+	Slave	Peripheral protocol chip	—	●	●	●	12 MBit/s
PROFICHIP	VPC LS	Slave	Low Cost, Single Chip, 32 I/O bits directly connectable to chip	—	●	—	—	12 MBit/s

Table 11: Available PROFIBUS protocol chips

power electronics are required as external components. Examples include the SPM2 ASIC from Siemens, the IX1 Chip from M2C and the VPCLS-ASIC from PROFICHIP.

8.2 Implementation of Intelligent Slaves

In this form of implementation the time critical parts of the PROFIBUS protocol are implemented on a protocol chip and the remaining protocol parts are implemented as software on a microcontroller. The DPC31 chip from Siemens represents a combination of protocol chip and microcontroller. As pure protocol chips, the ASICs SPC3 (Siemens), VPC3+ (PROFICHIP) and IX1 (M2C) are currently available. These ASICs offer a general purpose interface that can be used together with common microcontrollers. Microprocessors with an integrated PROFIBUS core are another possibility.

8.3 Implementation of Complex Masters

Here too, the time-critical parts of the PROFIBUS protocol are implemented on a protocol chip and the remaining protocol parts as software on a microcontroller. The ASICs ASPC2 (Siemens), IX1 (M2C) and PBM (IAM) are currently available for the implementation of complex master devices. They can be operated in conjunction with many current microprocessors.

8.4 Implementation of IEC 1158-2 Interfaces

In the implementation of buspowered field device with IEC 1158-2 interface, particular attention must be paid to low power consumption. As a rule, only a supply current of 10 mA is available for these devices. This has to supply the entire device including the bus interface and the measuring electronics.

To be able to meet these requirements, special modem chips are available from Siemens and Smar. These modems take the required operating energy for the entire device from the IEC 1158-2 bus connection and make it available as supply voltage for the other electronic components of the PA device. The SIM1 chip by Siemens is frequently used, since it works optimally with the SPC4 protocol chip. Fig. 21 shows a typical configuration with a standard round board.

For detailed notes on the implementation of the bus connection for PROFIBUS devices with IEC 1158-2 interface, please refer to technical guideline No. 2.092.

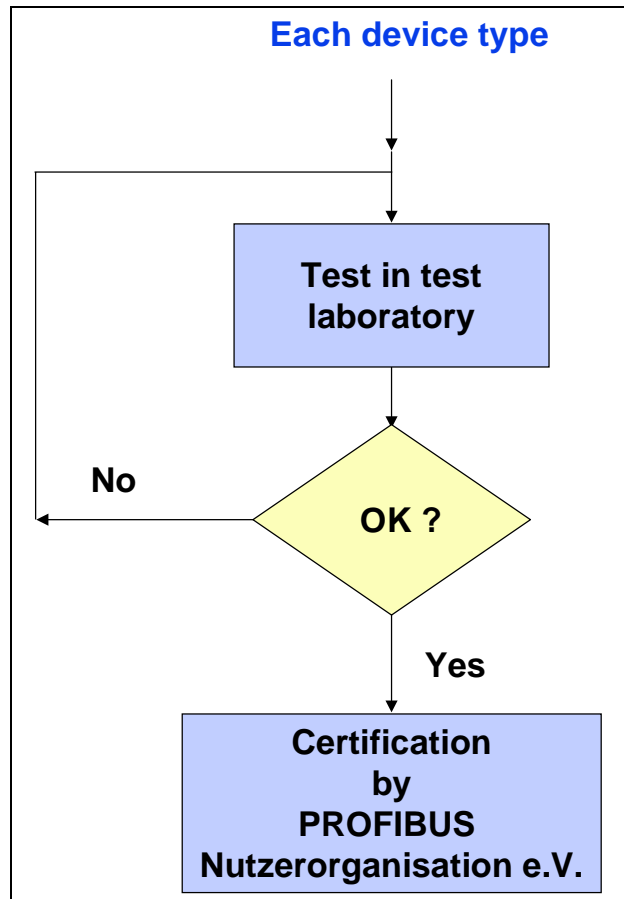

Fig. 22: Certification procedure

9. Device Certification

The PROFIBUS standard EN 50 170 is the basis on which devices can communicate together. To ensure that PROFIBUS devices from different manufacturers can communicate easily with each other, the PROFIBUS User Organization has established a comprehensive quality assurance procedure, under which certificates are issued for tested devices based on the test reports of accredited test laboratories.

The objective of certification is to give users the necessary security for the common operation of devices from different manufacturers. To achieve this, it is necessary to subject the various devices to a comprehensive test in test laboratories. Errors due to misinterpretation of the standard by development engineers are detected and corrected before the device is used in real applications. Interoperability of the device with other certified devices is also tested. It is important that the device test is performed by independent test experts. On successful completion of the test, a certificate can be requested from the PROFIBUS User Organization.

Certification is based on EN 45000. As specified in this standard, the PROFIBUS User Organization has accredited test laboratories as neutral, manufacturer-independent testing sites. The device test is performed at these facilities, which is the basis for the certification. Test and certification procedures are defined in the following PROFIBUS guidelines:

Test specifications for slaves: No. 2.032
 Test specifications for PA field devices: No. 2.061
 Test specifications for DP masters: No. 2.071

Different test procedures are defined for master and slave devices depending on the complexity of the protocol. The tests consist of conformity and interoperability tests, which have proven themselves many times in actual practice. The certification procedure (see Fig. 22) is described in the following using a DP device as an example. Prior to the test the manufacturer must apply for an Ident number from the PROFIBUS User Organization and prepare a GSD file for the device. All test laboratories use a uniform testing procedure. The test is documented in detail. The records are available to the manufacturer and the PROFIBUS User Organization. The test report is the basis for the award of the certificate.

The **hardware test** examines the electronics of the PROFIBUS interface. The interface is checked for compliance with the RS 485 specification. The electrical characteristics (i.e., terminating resistors, bus interface and line level) are tested. In addition, technical documentation and entries in the GSD file are checked against the parameters of the device.

The **function test** examines the bus access and transmission protocol, as well as the functionality of the device. The GSD is used to parameterize and adapt the test system. The black box test procedure is used. This procedure requires no knowledge of the internal structure of the implementation. The reactions generated by the device under test can be monitored on the bus and recorded via the bus monitor. If necessary, the outputs of the device are also monitored and recorded. During test sequences which are dedicated to the time relationships on the bus, test personnel analyze the recorded data with a bus monitor and compare them with the standard values.

The **conformity test** is the main part of the test. Protocol implementation is checked for conformity with the PROFIBUS standard. The desired behavior is combined to form test sequences which can be adapted to the device under test. Actual behavior is analyzed and compared with the desired behavior, and the results are recorded in a protocol file.

- **Behavior in case of fault:** Bus faults (i.e., bus interruption, short circuit of the bus line and failure of the supply voltage) are simulated.
- **Addressability:** The device is addressed under any three addresses within the address range and tested for correct functioning.
- **Diagnostic data:** The diagnostic data must correspond to the entry in the GSD and to the standard. This requires external triggering of the diagnostic.
- **Mixed operation:** Combination slaves are checked for operation with an FMS and DP master.

During the **interoperability and load test**, interoperability with several PROFIBUS devices of other vendors is tested in a multi-vendor environment.

A check is made to determine whether the functionality of the total system continues to be maintained when the device is added to the system. In addition, operation with various masters is tested.

After a device has passed all tests successfully, the vendor can apply for a certificate from the PROFIBUS User Organization. Every certified device receives a certification number as reference. The certificate is valid for 3 years but can be prolonged after an additional check. For addresses of the PROFIBUS testing laboratories see the PROFIBUS product guide or the PROFIBUS homepage on the Internet at: <http://www.profibus.com>.

10. Further Technical Developments

At the time of publication of this brochure, the PROFIBUS User Organization has initiated some further technical developments. The aim is to provide PROFIBUS with new functions in order to open up additional fields of application. This is to establish PROFIBUS as the standard fieldbus for practically all industrial applications.

Only a few years ago savings of 40 % for wiring costs through the use of fieldbus technology in a system were regarded as sensational, these days, it is simply taken for granted.

Now it is a question of reducing engineering costs even further and extending the range of applications in order to be able to use a uniform, transparent communication system where special buses are still currently required. This will lead to further significant savings in spare parts storage, commissioning, training and maintenance, at the same time significantly increase the competitiveness of machines and systems on the world market.

In view of the installed base of more than 3 million devices, great importance is being attached to compatibility with existing devices in the further development of PROFIBUS.

PROFIBUS & Ethernet

This PROFIBUS innovation concerns the open, transparent coupling of PROFIBUS and Ethernet. PROFIBUS thus takes account of the trend towards company-wide data communication from control systems down to the level of distributed field de-

VICES. The PROFIBUS User Organization intends to implement this in three stages:

- Mapping of engineering services from PROFIBUS to TCP/IP, access to the process image, parameterization and diagnostic data as well as the definition of the relevant software interface on the basis of OPC. This means that the user can configure and monitor PROFIBUS devices worldwide via Ethernet and Internet. Process, parameterization and diagnostic data of field devices are thus also available for the software familiar in office environments.
- Direct routing from TCP/IP to PROFIBUS. Internet technology and the Microsoft world are arriving on the field level. For example, web servers will now be possible in field devices. Microsoft-based operating systems in complex field devices can access well-known services.
- Complex field devices are represented as distributed, object-oriented systems. Simple field devices can be integrated into this world via proxy server concepts. This vision – the co-existence of simple distributed field devices with complex systems – is supported even more actively in this phase. Standardized access operations permit the services required for this, and thus the merging of PROFIBUS and Ethernet.

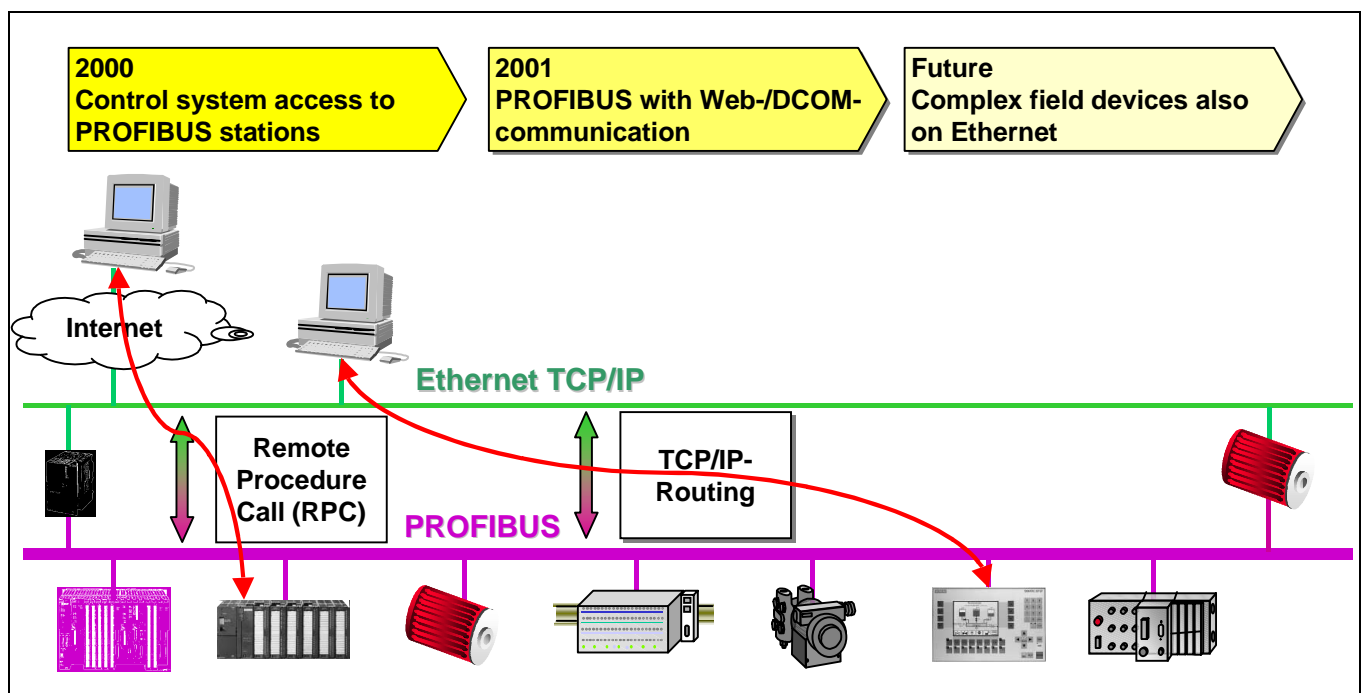

Fig.23: Integration of Ethernet in the communication with PROFIBUS

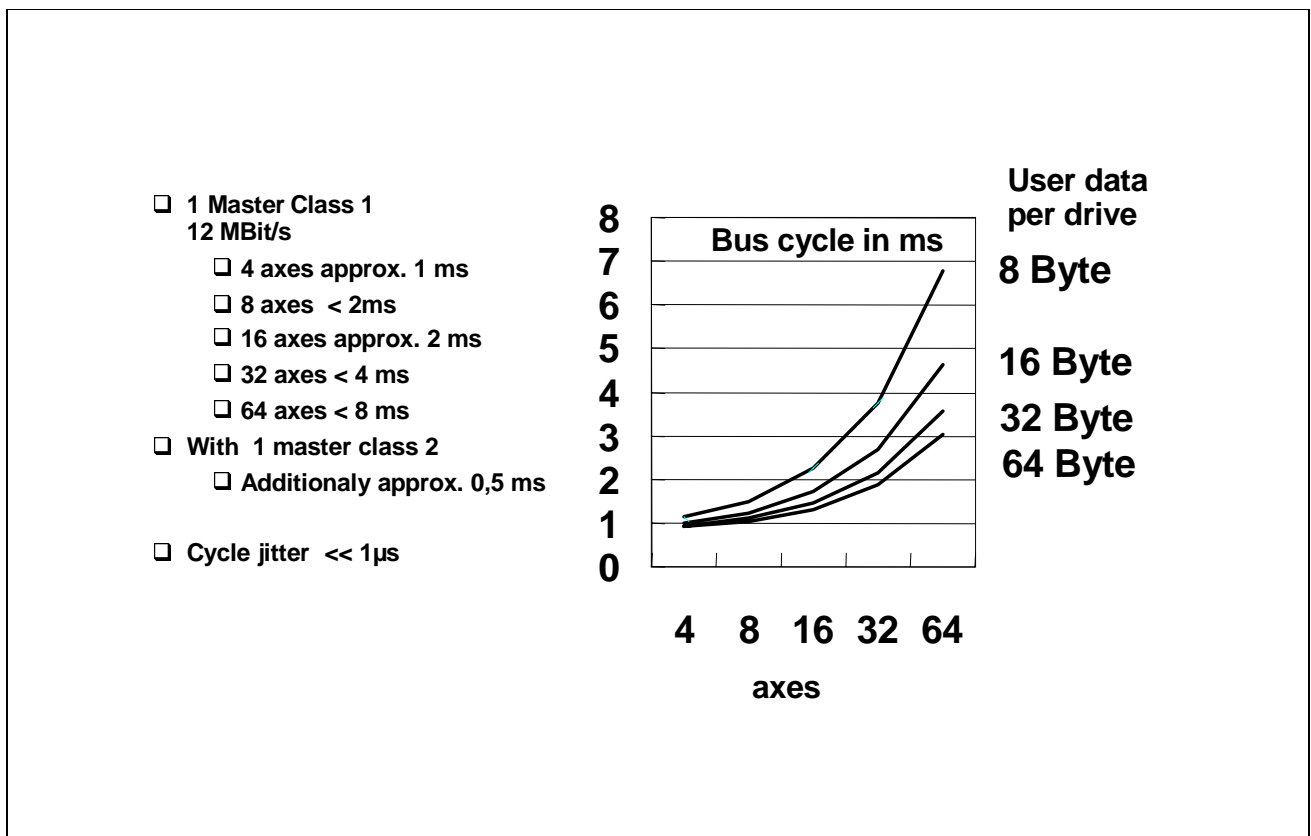

Fig.24: Bus cycle time with clock synchronization

New functions for motion control

Another innovation concerns the field of variable-speed drives. Together with leading drive manufacturers, it is the aim of the PROFIBUS User Organization to provide control of fast motion sequences using PROFIBUS. With the new functions digital closed-loop controls can be realized in future with PROFIBUS, whereby the task is to synchronize the cycles of the application software in the higher-level system, the bus transmission and the cycles of the application software in the drives.

These technical requirements are to be implemented by supplementing new functions in the PROFIBUS protocol for clock synchronization and slave-to-slave communication between the drives. The aim is to operate twelve axes synchronously with a bus cycle time of less than two milliseconds and also - without disturbing the cycle - to allow acyclic parameter access for operating, monitoring and engineering tasks.

This further development became necessary as it was simply not possible to implement all the demands of drive technology with one system using the open fieldbuses currently available.

If, for example, the bus is required, not only for the control of drives but also for reading in and displaying distributed I/Os or for display and operating functions, users are currently still required to distribute these functions over several buses. The new

PROFIBUS functions for motion control will extend the functions of PROFIBUS in such a way that users will no longer have to use special drive buses in many applications.

Clock synchronization will be implemented using an equidistant clock signal on the bus system. This cyclic, equidistant clock will be sent by the master to all bus stations as a global control telegram.

Master and slave can then use this signal to synchronize their applications. For drive technology, synchronous communication forms the basis for drive synchronization. Not only telegram communication is implemented on the bus system in an equidistant time frame, but the internal control algorithms, such as the speed and current controllers in the drive unit or controller, are also synchronized in the higher-level automation system.

For typical drive applications, the jitter of the clock signal from cycle to cycle must be less than $1\ \mu\text{s}$. Larger deviations are regarded as cycle failures and are not processed. If one cycle is omitted, the following cycle must be within the time frame again. The system clock is set by the user in the course of the bus configuration.

Simple standard slaves, e.g. distributed I/O modules, can take part in this synchronous bus without any modifications. By using the Sync and Freeze functions, which are available today, the input and output data are frozen at the point in time of the cycle and transmitted in the next cycle. A precondition for correct synchronization in the overall system is that the number of masters on the bus should be restricted to one DP master class 1 (the automation system) and one DP master class 2 (the engineering tool).

To implement **slave-to-slave communication** the so-called publisher/subscriber model is used. Slaves declared as publishers make their input data available to other slaves, the subscribers, so that they can also be read by them. The communication is effected cyclically.

Existing slaves that have not yet implemented the protocol extensions can be operated on the same bus segment with drives that already support the new functions. The specification of the functions and services also takes account of simple implementation with available ASICs on the master and slave sides.

Conversion into the PROFIBUS specification began at the beginning of 1999. The aim is to publish the extended PROFIDRIVE profile before the end of 1999 and to work out the extensions in the DP protocol by the beginning of 2000.

11. Outlook

PROFIBUS has successfully proved itself in many thousands of applications in production, building and process automation. High cost savings, improved flexibility and greater availability of systems are the main reasons why more and more users worldwide are deciding in favor of PROFIBUS. From a range of more than 2000 available products and services, users can at any time select the best and most cost-effective product for their automation requirements.

Through continuing further technical developments, PROFIBUS is being adapted to meet future requirements as well. PROFIBUS is carrying out new functions that previously could only be implemented by special buses. For users, this has the advantage that they can use PROFIBUS for practically all industrial communication tasks.

Thanks to its worldwide acceptance, the general expectation is that PROFIBUS technology will soon be included in the international IEC 61158 standard and recognized as international field bus standard.

12. List of Abbreviations

ASIC	Application Specific Integrated Circuit
CR	Communication reference Local short designation for a communication relationship
CRL	Communication reference list The CRL contains a list with all communication relationships of a station
DP	Decentralized Periphery
DPM1	DP master (Class 1) The DPM1 is the central programmable controller for DP.
DPM2	DP master (Class 2) The DPM2 is a configuration device for DP.
EDD	Electronic Device Description
FDL	Fieldbus Data Link FDL is the data security layer (2) for PRO-FIBUS.
FDT	Fieldbus Device Type Vendor independent method for device descriptions
FMS	Fieldbus Message Specification Definition of the application services in FMS
GSD	Device Data Base File Electronic device data sheet
HMI	Human Machine Interface Operating and monitoring devices
LLI	Lower Layer Interface The LLI is part of the application layer (7) of PROFIBUS FMS
MAC	Medium Access Control The MAC decides when a device is given the right to send data
OV	Object dictionary The object dictionary contains the description of all communication objects of a FMS device
PA	Process Automation PROFIBUS Profile for Process Automation
SAP	Service Access Point Service access point in PROFIBUS layer 2

© Copyright by:

PROFIBUS Nutzerorganisation e.V.
Haid-und-Neu-Str. 7
D-76131 Karlsruhe

Phone++ 49 721 / 96 58 590

Fax: ++ 49 721 / 96 58 589

e-mail: PROFIBUS_International@compuserve.com

<http://www.profibus.com>