

## ERTMS/ETCS

### FFFIS for Eurobalise

REF : SUBSET-036

ISSUE : 3.1.0

DATE : December 17, 2015

Company	Technical Approval	Management approval
ALSTOM		
ANSALDO		
AZD		
BOMBARDIER		
CAF		
SIEMENS		
THALES		

## Modification History

Issue Date	Section Number	Modification/Description	Author
2.5.1 2011-01-19	All	The following technical modifications relative to version 2.4.1 apply to this version: <ul style="list-style-type: none"> <li>Down-link functionality is removed.</li> <li>EN 300 330 is replaced by EN 302 608 (a formal change only without technical impact).</li> <li>Removal of requirement on short default telegrams in section 5.2.2.8.6.</li> <li>Change of “should” to “shall” in section 6.3.</li> </ul> Other modifications herein are either clarifications, and/or made for improving the general quality of the specification. This update resolves CR 867.	Per Lundberg
2.5.2 2011-04-14	1.3	Removal of section 1.3 (Technical Modifications in This Version) and introduction of this Modification History.	Per Lundberg
2.5.3 2011-04-14		Modifications according to imperfections 036:537, 036:538, and 036:539.	Per Lundberg
2.5.4 2011-09-19		Modifications according to imperfections 036:540 and 036:541.	Per Lundberg
2.5.5 2011-09-30		Modifications according to imperfections 036:542 and 036:543.	Per Lundberg
2.5.6 2011-10-21	6.2.2.1	Modification according to imperfection 036:544 resolving CR 482.	Per Lundberg
2.5.7 2011-11-25	3.2, 4.2.8.2, 5.2.2.3	Modifications according to updated imperfection 036:507 resolving CR 867, and movement of footnote in section 4.2.8.2.	Per Lundberg
2.5.8 2012-01-12	5.6	Modifications according to imperfection 036:545 resolving the SUBSET-036 part of CR 890 (Balise installation in narrow curves).	Per Lundberg
2.5.9 2012-02-01		Modifications according to imperfections 036:546 through 036:555 after SG/ERA/EUG review and WGI meeting of January 31 2012.	Per Lundberg
2.5.10 2012-02-08		Removal of “Class 1” on the front page.	Per Lundberg
3.0.0 2012-02-24		Baseline 3 release version (only change of Issue number).	Per Lundberg
3.0.1 2015-11-10	5.6.2.3, 5.7.10.4.1, 5.7.10.7.2, 6.7.4	Update resolving CR 1180, CR 1188, and CR 1275.	Per Lundberg
3.0.2 2015-11-16	5.7.10.7.2, 6.7.4	Update after UNISIG internal review.	Per Lundberg
3.0.3 2015-12-11	4.2.9	Update as per review comment agreed in EECT meeting 16 (08/12/2015) (deletion of note [8] in section 4.2.9 as per CR1265 agreed solution)	Philippe Prieels

3.1.0 2015-12-17	-	Baseline 3 2 <sup>nd</sup> release version	Philippe Prieels
---------------------	---	--	---------------------

## **Foreword**

The main body of SUBSET-036, and the relevant Annexes designated as “normative”, constitute the mandatory requirements for achieving air-gap interoperability between any possible combination of wayside and train-borne equipment. Annexes designated as “informative”, either provide background information for the mandatory requirements, or outline non-mandatory requirements and optional functionality.

SUBSET-085 specifies test methods and tools for verification of compliance with the mandatory requirements of SUBSET-036 (this document).

## Contents

<b>1</b>	<b>INTRODUCTION</b>	<b>11</b>
<b>2</b>	<b>NORMATIVE REFERENCES</b>	<b>12</b>
<b>3</b>	<b>TERMINOLOGY AND DEFINITIONS</b>	<b>13</b>
<b>3.1</b>	<b>Acronyms and Abbreviations</b>	<b>13</b>
<b>3.2</b>	<b>Definitions</b>	<b>15</b>
<b>3.3</b>	<b>Influence of Tolerances</b>	<b>19</b>
<b>4</b>	<b>SPOT TRANSMISSION SYSTEM</b>	<b>20</b>
<b>4.1</b>	<b>Architectural Layouts</b>	<b>20</b>
4.1.1	Introduction	20
4.1.2	Units and Functions	20
4.1.3	Interfaces	21
4.1.4	Basic Functions	24
4.1.5	Management of Faults and Failures	25
<b>4.2</b>	<b>Functional Requirements</b>	<b>26</b>
4.2.1	Balise Tele-powering	26
4.2.2	Up-link Data Transmission	26
4.2.3	Intentionally Deleted	27
4.2.4	Location Reference	27
4.2.5	Cross-talk Protection	28
4.2.6	Compatibility with existing systems	31
4.2.7	Interoperability with existing KER Systems	31
4.2.8	Quality of the Data Transmission Channel	32
4.2.9	Timing and Distance Requirements	33
4.2.10	Location Reference Accuracy	35
<b>4.3</b>	<b>Coding Requirements</b>	<b>36</b>
4.3.1	Introduction	36
4.3.2	Encoding Requirements	37
4.3.3	Telegram Switching	40
4.3.4	Decoding Requirements	41
<b>4.4</b>	<b>RAMS Requirements</b>	<b>42</b>
4.4.1	General	42
4.4.2	Top level functionality	42
4.4.3	Reliability	42
4.4.4	Availability	43
4.4.5	Intentionally Deleted	43
4.4.6	Safety	43

<b>4.5</b>	<b>Reference Axes and Origins of Co-ordinates</b>	<b>50</b>
<b>4.6</b>	<b>Electrical Requirements</b>	<b>51</b>
4.6.1	On-board Equipment	51
4.6.2	Wayside Equipment	51
<b>5</b>	<b>UP-LINK BALISE</b>	<b>52</b>
<b>5.1</b>	<b>Architectural Layouts</b>	<b>52</b>
<b>5.2</b>	<b>Balise air-gap Interface</b>	<b>52</b>
5.2.1	Balise Tele-powering	52
5.2.2	Up-link Data Transmission	53
<b>5.3</b>	<b>Balise Controlling Interfaces</b>	<b>68</b>
5.3.1	Introduction	68
5.3.2	Up-link Data Input (Interface 'C1')	69
5.3.3	Auxiliary Energy Input (Interface 'C6')	73
5.3.4	Common Mode Signal Levels	74
<b>5.4</b>	<b>Programming Principles</b>	<b>74</b>
<b>5.5</b>	<b>RAMS Requirements</b>	<b>75</b>
5.5.1	Balise functionality	75
5.5.2	Reliability	77
5.5.3	Availability	77
5.5.4	Intentionally Deleted	77
5.5.5	Safety	78
<b>5.6</b>	<b>Installation Requirements for Balises</b>	<b>83</b>
5.6.1	Reference Axes	83
5.6.2	General Installation Requirements for Balises	83
5.6.3	Distance between Balises	86
5.6.4	Number of Balises in a Balise Group	86
5.6.5	Balise Installation in Narrow Curves	87
<b>5.7</b>	<b>Specific Environmental Conditions for Balises</b>	<b>91</b>
5.7.1	Operational Temperature	91
5.7.2	Storage	91
5.7.3	Sealing, Dust and Moisture	91
5.7.4	Mechanical Stress	91
5.7.5	Meteorological Conditions	91
5.7.6	Lightning	91
5.7.7	Chemical Conditions	91
5.7.8	Biological Conditions	92
5.7.9	Debris	92

5.7.10	Metallic Masses and Cables in proximity	94
<b>5.8</b>	<b>Specific EMC Requirements</b>	<b>106</b>
5.8.1	In-band Emission	106
5.8.2	Out-band Emission	106
5.8.3	Susceptibility Requirements	106
<b>5.9</b>	<b>Specific Electrical Requirements</b>	<b>106</b>
5.9.1	General	106
5.9.2	Provisions against accidental contact with the traction power voltage	106
5.9.3	Insulation co-ordination	107
5.9.4	Dielectric Tests	107
<b>5.10</b>	<b>Requirements for Test Tools and Procedures</b>	<b>107</b>
<b>5.11</b>	<b>Quality and Safety Assurance</b>	<b>107</b>
<b>6</b>	<b>ON-BOARD EQUIPMENT</b>	<b>108</b>
<b>6.1</b>	<b>Architectural Layouts</b>	<b>108</b>
<b>6.2</b>	<b>Antenna Air-gap Interface</b>	<b>108</b>
6.2.1	Tele-powering Energy Transmission	108
6.2.2	Up-link Data Reception	112
<b>6.3</b>	<b>Intentionally Deleted</b>	<b>114</b>
<b>6.4</b>	<b>RAMS Requirements</b>	<b>115</b>
6.4.1	On-board Transmission Equipment functionality	115
6.4.2	Reliability	116
6.4.3	Availability	116
6.4.4	Intentionally Deleted	116
6.4.5	Safety	116
<b>6.5</b>	<b>Installation Requirements for Antennas</b>	<b>123</b>
6.5.1	Reference Axes	123
6.5.2	Metal Masses in the Track	123
6.5.3	Antenna sizes and Mounting Requirements	124
6.5.4	Allowed displacements for the Antenna Unit	125
<b>6.6</b>	<b>Specific Environmental Conditions for Antennas</b>	<b>126</b>
6.6.1	Operational Temperature	126
6.6.2	Storage	126
6.6.3	Sealing, Dust and Moisture	126
6.6.4	Mechanical Stress	126
6.6.5	Meteorological Conditions	126
6.6.6	Chemical Conditions	126
6.6.7	Biological Conditions	126

6.6.8	Debris	127
6.6.9	Metallic Masses	127
6.6.10	Cables	128
<b>6.7</b>	<b>Specific EMC Requirements for Antennas</b>	<b>129</b>
6.7.1	General	129
6.7.2	In-band Emission	129
6.7.3	Out-band Emission	129
6.7.4	Eurobalise Transmission Susceptibility	130
6.7.5	Out-band Susceptibility	130
<b>6.8</b>	<b>Specific Electrical Requirements</b>	<b>130</b>
<b>6.9</b>	<b>Requirements for Test Tools and Procedures</b>	<b>130</b>
<b>6.10</b>	<b>Quality and Safety Assurance</b>	<b>130</b>
<b>ANNEX A (INFORMATIVE), ADDITIONAL TECHNICAL INFORMATION</b>		<b>131</b>
<b>A1</b>	<b>CODING BACKGROUND</b>	<b>131</b>
<b>A1.1</b>	<b>Encoding</b>	<b>131</b>
A1.1.1	General	131
A1.1.2	Comment to the 10-to-11-Bit Transformation	132
<b>A1.2</b>	<b>Decoding</b>	<b>132</b>
A1.2.1	Synchronisation	132
A1.2.2	Comments to the Receiver Operation	133
<b>A1.3</b>	<b>Safety Considerations</b>	<b>134</b>
A1.3.1	Introduction	134
A1.3.2	Random Bit Errors and Burst Errors	134
A1.3.3	Bit Slips and Insertions	135
A1.3.4	Telegram Change	135
A1.3.5	Format Mixing	135
A1.3.6	Over-sampling and Under-sampling	135
<b>ANNEX B (NORMATIVE), ADDITIONAL TECHNICAL REQUIREMENTS</b>		<b>136</b>
<b>B1</b>	<b>REQUIREMENTS ON THE TELE-POWERING SIGNAL</b>	<b>136</b>
<b>B1.1</b>	<b>Toggling Tele-powering signal</b>	<b>136</b>
<b>B1.2</b>	<b>Non-toggling Tele-powering signal</b>	<b>136</b>
<b>B2</b>	<b>THE 10-TO-11 BIT TRANSFORMATION SUBSTITUTION WORDS</b>	<b>137</b>
<b>ANNEX C (NORMATIVE), ADDITIONAL TECHNICAL REQUIREMENTS</b>		<b>140</b>
<b>C1</b>	<b>RETURN LOSS DEFINITION</b>	<b>140</b>
<b>C2</b>	<b>FERRITE DEVICES FOR LZB CABLE APPLICATIONS</b>	<b>140</b>
<b>ANNEX D (INFORMATIVE), RECOMMENDED AND OPTIONAL REQUIREMENTS</b>		<b>141</b>



<b>D1</b>	<b>INTEROPERABILITY WITH EARLIER GENERATIONS OF ATP</b>	<b>141</b>
<b>D1.1</b>	<b>Requirements on the Tele-powering link to make Interoperability possible</b>	<b>141</b>
<b>D1.2</b>	<b>Transfer Syntax</b>	<b>141</b>
D1.2.1	Intentionally Deleted	141
D1.2.2	Handshaking	141
D1.2.3	Disconnection	141
D1.2.4	Synchronisation	141
<b>D1.3</b>	<b>EMC Requirements for Tele-powering</b>	<b>142</b>
<b>D2</b>	<b>INTENTIONALLY DELETED</b>	<b>142</b>
<b>D3</b>	<b>EARLIER ATP SYSTEMS, CONSIDERED PRODUCTS</b>	<b>142</b>
<b>D4</b>	<b>BALISE BLOCKING SIGNAL OUTPUT (INTERFACE 'C4')</b>	<b>143</b>
<b>D4.1</b>	<b>General</b>	<b>143</b>
<b>D4.2</b>	<b>Physical Transmission</b>	<b>143</b>
D4.2.1	Transmission Medium	143
D4.2.2	Electrical Data	144
D4.2.3	Functional Data	144
<b>D4.3</b>	<b>Transmission of Messages on Application Level</b>	<b>145</b>
D4.3.1	General	145
D4.3.2	Message Description	145
D4.3.3	Repetition Rate	145
D4.3.4	Re-triggerability	145
<b>D4.4</b>	<b>Safety</b>	<b>145</b>
<b>ANNEX E</b>	<b>INTENTIONALLY DELETED</b>	<b>145</b>
<b>ANNEX F (INFORMATIVE),</b>	<b>CROSS-TALK ANALYSIS METHOD</b>	<b>146</b>
<b>F1</b>	<b>BACKGROUND</b>	<b>146</b>
<b>F2</b>	<b>MATRIX</b>	<b>146</b>
<b>F2.1</b>	<b>General</b>	<b>146</b>
<b>F2.2</b>	<b>Methodology to demonstrate compliance with THR</b>	<b>147</b>
<b>F2.3</b>	<b>I/O Diagrams</b>	<b>148</b>
<b>F3</b>	<b>STEP-BY-STEP METHODOLOGY</b>	<b>151</b>
<b>F4</b>	<b>DESCRIPTION OF SCENARIOS</b>	<b>152</b>
<b>ANNEX G (NORMATIVE),</b>	<b>GUIDELINES RELATED TO METALLIC MASSES</b>	<b>153</b>
<b>G1</b>	<b>INTRODUCTION</b>	<b>153</b>
<b>G2</b>	<b>GUIDELINES FOR DETERMINING APPLICABLE RULES</b>	<b>153</b>
<b>G2.1</b>	<b>Step 1</b>	<b>153</b>

<b>G2.2</b>	<b>Step 2</b>	<b>154</b>
<b>G2.3</b>	<b>Step 3</b>	<b>155</b>
<b>G2.4</b>	<b>Step 4</b>	<b>155</b>

# 1 Introduction

The present specification considers requirements and performance for wayside and On-board transmission units, interacting for a reliable and safety related data transmission between track and train.

These units are the Balises, (standing alone fixed data Balises, or controlled data Balises linked to the wayside signalling system) and the On-board Antenna Units integrated with the transmission functionality of the overall On-board ATP/ATC equipment.

This specification considers specific application and environmental conditions for Balises and Antenna Units (e.g., installation constraints and debris) that may have a direct impact on the achievable transmission performance. It also defines constraints and conditions for the external interfaces of the Eurobalise Transmission System with other interacting equipment, both wayside and On-board.

A detailed “Coding Strategy” involving telegram generation, transmission, and reception, covers the issue of statistical data protection against random error conditions in the entire communication path.

Requirements of compatibility or interoperability with earlier generations of ATP/ATC transmission systems, using similar electrical characteristics, are explicitly defined in order to allow an easy transition from those systems.

Applicable sub-clauses of existing European Norms that cover issues of general interest (e.g., environmental conditions), that are deemed relevant for the purposes of an interoperable track-train data transmission, are also considered.

This specification specifies detailed functional and non-functional requirements for the Balise, identified as a basic wayside constituent of interoperability.

A special focus is given to the air-gap interface, where the Balise interacts with the On-board equipment. The air-gap requirements for the Balise have been defined in all needed details in order to serve as a solid basis for the interoperability with any ERTMS/ETCS compliant On-board equipment.

The interface of the Balise with the wayside equipment has also been considered for the purpose of interchangeability of wayside components.

This specification specifies a set of functional and non-functional requirements for the transmission parts of the On-board equipment, which are deemed indispensable for the purpose of interoperability. The mandatory requirements, applicable to the Balise location and transmission functionality, integrate other mandatory requirements specified for the ERTMS/ETCS On-board equipment by correlated specifications. Also in this case, a special focus is given to the air-gap interface, where the On-board Antenna Unit interacts with the wayside Balise.

Compared with the Balise case, only a minimum set of mandatory requirements has been defined for the On-board equipment. This allows any kind optimisation, in costs and performance, for the overall architecture of the On-board system, while still ensuring interoperability.

Detailed requirements on test, test procedures, and test tools are given in SUBSET-085.

This specification does not explicitly consider the following issues, because they are already considered by the correlated specifications:

- Contents and structure of the user data exchanged between track and train (see UNISIG SUBSET-026);
- The Interface between the transmission functionality and the rest of the On-board ATP/ATC system;
- Quantitative RAMS performance regarding the transmission functionality of the On-board equipment (see UNISIG SUBSET-091).

## 2 Normative References

This specification incorporates, by dated or undated references, provisions from other publications. These normative references are cited at the appropriate places in the text, and the publications are listed hereafter. For dated references, subsequent amendments to, or revisions of, any of these publications apply to this specification only when incorporated herein by amendment or revision. For undated references, the latest edition of the publication referred to apply.

- I. UNISIG Specifications:
  - A. UNISIG SUBSET-023; Glossary of UNISIG Terms and Abbreviations
  - B. UNISIG SUBSET-026; System Requirement Specification
  - C. UNISIG SUBSET-040; Dimensioning and Engineering Rules
  - D. UNISIG SUBSET-091; Safety Requirements for the Technical Interoperability of ETCS in Levels 1 & 2
  - E. UNISIG SUBSET-085; Test Specification for Eurobalise FFFIS
  - F. UNISIG SUBSET-100; Interface 'G' Specification
- II. CENELEC/ETSI/IEC Norms and Recommendations:
  - A. EN 50121-3-2; Railway applications, Electromagnetic compatibility, Rolling stock - Apparatus.
  - B. EN 50121-4; Railway applications, Electromagnetic compatibility, Emission and immunity of the signalling and telecommunications apparatus.
  - C. EN 302 608; Electromagnetic compatibility and Radio spectrum Matters (ERM); Short Range Devices (SRD); Radio equipment for Eurobalise railway systems, Harmonised EN covering the essential requirements of article 3.2 of the R&TTE Directive.
  - D. EN 50122-1; Railway applications, Fixed Installations, Protective provisions relating to electrical safety and earthing.
  - E. EN 50124-1; Railway applications, Insulation coordination, Basic requirements, Clearance and creepage distances for all electrical and electronic equipment.
  - F. EN 50125-1; Railway applications, Environmental conditions for equipment, Equipment on-board rolling stock.
  - G. EN 50125-3; Railway applications, Environmental conditions for equipment, Equipment for signalling and telecommunications.
  - H. EN 50126; Railway applications, The specification and demonstration of Reliability Availability Maintainability and Safety.
  - I. EN 50128; Railway applications, Communications signalling and processing systems, Software for railway control and protection system.
  - J. EN 50129; Railway Applications, Safety related electronic systems for signalling.
  - K. EN 50155; Railway applications, Electronic equipment used on rolling stock.
  - L. EN 50159; Railway applications, Communication Signalling and Processing systems, Safety-related communication in closed transmission systems.
  - M. IEC 60529; Specification for degrees of protection provided by enclosures.
  - N. EN 50289-1-8; Communication Cables, Specification for Test Methods.

## 3 Terminology and Definitions

### 3.1 Acronyms and Abbreviations

In general, the acronyms of UNISIG SUBSET-023 apply. Additionally, the following list of acronyms applies within this specification:

Acronym	Explanation
AM	Amplitude Modulation
ASK	Amplitude Shift Keying
BCH	Bose-Chaudhuri-Hocquenghem
BER	Bit Error Rate
CW	Continuous Wave
DBPL	Differential Bi Phase Level
DC	Direct Current
Ebicab	ATP system based on Magnetic Transponder Technology
FIFO	First In, First Out
FSK	Frequency Shift Keying
GF(2)	Galois Field base 2
H/W	Hardware
ID	Identification code
I/O	Input-Output
KER	KVB, Ebicab, RSDD
KVB	Controle de Vitesse par Balise (ATP system based on Magnetic Transponder Technology)
LSB	Least Significant Bit
MSB	Most Significant Bit
MTIE	Maximum Time Interval Error
NV	Non Volatile
RMS	Root Mean Square
RSDD	Ripetizione Segnali Discontinua Digitale (ATP system based on Magnetic Transponder Technology)
S/W	Software

The following abbreviations apply:

<b>Abbreviation</b>	<b>Explanation</b>
max.	maximum
min.	minimum
Ref.	Reference
Vpp	Volts peak to peak

## 3.2 Definitions

In general, the definitions of UNISIG SUBSET-023 apply. Additionally, the following list of definition applies within this specification:

Term	Definition
<b>Antenna Reference Marks</b>	These indicate the electrical centre of the Antenna Unit.
<b>Antenna Unit</b>	The On-board Transmission Unit, with the main functions to transmit signals to and/or receive signals from the Balise through the air gap.
<b>Balise</b>	A wayside Transmission Unit that uses the Magnetic Transponder Technology. Its main function is to transmit and/or receive signals through the air gap. The Balise is a single device mounted on the track, which communicates with a train passing over it. In this specification, Balise is used as a short word for Eurobalise, unless otherwise stated.
<b>Balise Cross-talk Zone</b>	The zone outside the Main Lobe Zone and the Side lobe Zone, where less stringent requirements on Up-link field conformity with the reference field is defined for the Balise.
<b>Balise Group</b>	One or more Balises that on a higher system level together create a quantity of information related to the location reference in the track, the direction of validity of data, and train protection information. This is the location in the track where spot transmission occurs.
<b>Balise Information</b>	The information part of the Balise Telegram (i.e., the telegram without CRC, control bits, and synchronisation bits), i.e., the user bits.
<b>Balise Reference Marks</b>	These correspond to the centre of symmetry of the Balise radiation pattern.
<b>Balise Telegram</b>	The Balise Telegram located in the Balise Data. The telegram consists of information, CRC, and synchronisation bits.
<b>Balise Transmission Module (BTM)</b>	An On-board module for intermittent transmission between track and train, which processes Up-link signals and telegrams from a Balise. It interfaces the ERTMS/ETCS Kernel and the Antenna Unit.
<b>BTM Function</b>	An On-board function that processes Up-link data, and that interfaces the ERTMS/ETCS Kernel and the On-board Antenna Unit. This is not necessarily a physical device, and it is not a Constituent itself (but is part of the ERTMS/ETCS On-board Constituent).
<b>Cluster of Balises</b>	One or more Balises that seen from the vehicle, regardless of the contained information, are close to each other. The definition of 'close' is dependent on the Maximum Permitted Speed.
<b>Compatibility</b>	Compatibility between two systems means that they can coexist under defined conditions without interfering with each other as to specified functions.

Term	Definition
<b>Contact Length</b>	In general, the distance between the place where a train becomes able to communicate with a device (e.g., a Balise) to the place where communication becomes impossible. In particular for this specification, the longitudinal distance that is needed to ensure transmission from the Balise with the specified quality (e.g., see sub-clause 4.2.8.2 on page 32). The contact length is dependent on the specific lateral displacement and on the mounting height.
<b>Contact Volume</b>	The volume constituted by the Contact Lengths for all lateral displacements and mounting heights of the antenna where transmission from the Balise is guaranteed with the specified quality.
<b>Contact Zone</b>	See Main Lobe Zone.
<b>Cross-talk</b>	When a telegram is read from a Balise that should not be read, e.g., a Balise on another track.
<b>Cross-talk protected zone</b>	The zone in the vicinity of the Balise where transmission is not intended to take place.
<b>Default Telegram</b>	This is an Up-link Telegram permanently stored in controlled Up-link Balises. This telegram is transmitted in the event of communication failure between the Up-link Balise and the LEU. This is mainly used for failure detection purposes (but constitutes a valid Eurobalise Telegram).
<b>Eurobalise</b>	One set of technical solutions for Balises used in an ERTMS/ETCS installation. A Eurobalise is a Balise that fulfils the mandatory requirements of clauses 4 and 5 of this specification.
<b>Eurobalise Transmission System</b>	The Pan-European spot transmission system for transmission between wayside and the ERTMS/ETCS Kernel. It is a sub function in the total European Rail Traffic Management System, ERTMS, and it is one of the sub-systems in the railways' European Train Control System, ETCS.
<b>Eurobalise Telegram</b>	This is a telegram fulfilling the Coding Requirements, and carrying application data for the ERTMS/ETCS system according to the ETCS language. The length of the telegram is either 341 bits (including 210 User Bits) which is also referred to as "short telegram", or 1023 bits (including 830 User Bits) which is also referred to as "long telegram".
<b>'f<sub>L</sub>'</b>	The lower of the two frequencies used by the Up-link Balise to accomplish the FSK type of modulation for transmitting Eurobalise Telegrams.
<b>'f<sub>H</sub>'</b>	The higher of the two frequencies used by the Up-link Balise to accomplish the FSK type of modulation for transmitting Eurobalise Telegrams.



Term	Definition
<b>Fixed Data</b>	Data transmitted to and from the train, and that can only be changed by reconfiguration, i.e., data that does not change during normal railway operation.
<b>Fixed Telegram</b>	A telegram with fixed data in the Up-Link Balise.
<b>Interface ‘A’</b>	The air gap interface between the wayside Eurobalise and the On-board Transmission Equipment. It is used for data exchange between track and train. The interface uses magnetic coupling.
<b>Interface ‘C’</b>	The wayside interface between the LEU and the Eurobalise. Telegrams are sent/received serially at the same data rate as in the air gap.
<b>Interface ‘S’</b>	The input to the LEU (Up-link) that interfaces the different national railway signalling equipment. This is not part of the Eurobalise Transmission System.
<b>Interface ‘V’</b>	The test interface between the On-board Transmission Equipment, and external test and verification equipment. This interface is used for controlling the BTM function, and for acquiring data during system verification tests (certification tests).
<b>Interoperability</b>	In general, Interoperability between two systems means that they can operate mutually at a specified time and place as to specified function. In particular, Interoperability means the ability of the Trans-European high speed rail system to allow the safe and uninterrupted movement of high speed trains that accomplish the specified levels of performance.
<b>Lineside Electronic Unit (LEU)</b>	A Wayside unit that interfaces the national Wayside Signalling Equipment and the Balise. Specifically for the purpose of Up-link, it is a device for communicating variable signalling data to controlled Balises. LEU is not within the scope of this specification.
<b>Location Reference</b>	A position in the track. For a single Balise it refers to the reference mark of the Balise (see sub-clause 4.5.1), and for a Balise Group it refers to Balise number one of the Balise Group (the Balise with N_PIG = 0).
<b>Magnetic Transponder Technology</b>	A method that uses magnetic coupling in the air gap between a transmitter and a receiver for conveying data and energy. In the Eurobalise Transmission System context, it considers systems using the 27 MHz band for Tele-powering and the 4.5 MHz band for Up-link transmission. The magnetic field is mainly vertical, and the transponder is located in the centre of the track.
<b>Main Lobe Zone</b>	The zone above the Balise, where the highest requirements on field conformity of the magnetic field with the reference field apply for the Balise. The Main Lobe Zone is identical to the previously used Contact Zone.
<b>Maximum Permitted Speed</b>	The highest speed that any train is permitted to operate at, where Balises or concerned metallic objects are installed. The actual train speed may be higher than the Maximum Permitted Speed due to speed measurement inaccuracy and brake intervention limits.
<b>Non-toggling Tele-powering signal</b>	50 kHz modulation of the Tele-powering signal, where each modulation pulse has the same length. Characteristic of the modulation used in the older KER ATP/ATC systems.
<b>On-board ATP/ATC</b>	Synonymous to Train Borne Equipment defined in UNISIG SUBSET-023.

Term	Definition
<b>On-board Transmission Equipment</b>	Consists of Antenna Unit(s) (for Magnetic Transponder Technology), and the Balise Transmission Function. It functionally matches the air gap interface and the ERTMS/ETCS Kernel.
<b>Pitch</b>	An angular deviation where the axis of rotation coincides with the Y-axis (see sub-clause 4.5 on page 50).
<b>Reliability Cross-talk</b>	Disturbing effect on the transmission of data such that correct transmission is unattainable.
<b>Safety Cross-talk</b>	The acceptance of unwanted signals and data, interpreted as valid, by an unintended receiver.
<b>Side lobe Zone</b>	The zone relative to the Balise outside the Main Lobe Zone, where less stringent field conformity with the reference field is defined for the Balise.
<b>Spot Transmission System</b>	Consists of LEU, Balise, and On-board Transmission Equipment. The LEU is not within the scope of this specification.
<b>Telegram</b>	A Telegram contains one header and an identified and coherent set of packets. There are several types of Telegrams referred to in this specification.
<b>Tele-powering</b>	The method used for powering a Balise from an Antenna Unit through the air gap.
<b>Tele-powering signal</b>	A signal transmitted by the On-board Transmission Equipment, which activates the Balise upon passage.
<b>Tilt</b>	An angular deviation where the axis of rotation coincides with the X-axis (see sub-clause 4.5 on page 50).
<b>Toggling Tele-powering Signal</b>	50 kHz modulation of the Tele-powering signal, where every other modulation pulse is longer. Characteristic of the modulation used in an On-board Transmission Equipment in interoperable mode.
<b>Up-link</b>	All functions that are needed in the Eurobalise Transmission System to constitute the communication from the LEU, or from the fixed Balise, to the ERTMS/ETCS Kernel.
<b>Up-link Telegram</b>	This is a Eurobalise Telegram used for Up-link communication, including one User Bit categorising the telegram as valid for Up-link application.
<b>Valid Telegram</b>	A Balise Telegram fulfilling the coding requirements of sub-clause 4.3 on page 36.

<b>Term</b>	<b>Definition</b>
<b>Variable Data</b>	Data transmitted to and from the train, and that may change during normal railway operation.
<b>Yaw</b>	An angular deviation where the axis of rotation coincides with the Z-axis (see sub-clause 4.5 on page 50).

### 3.3 Influence of Tolerances

The requirements in this specification do not involve the error of the test equipment that is used in the test process, unless this is expressly written. This means a maximum limit value shall be decreased and a minimum limit value shall be increased with the applicable measurement error during test. The same principle applies to propagation of admitted tolerances when several quantities are combined or analysed. Further details are found in SUBSET-085.

## **4 Spot Transmission System**

### **4.1 Architectural Layouts**

#### **4.1.1 Introduction**

The Eurobalise Transmission System is a safe spot transmission based system conveying safety related information between the wayside infrastructure and the train.

The Eurobalise Transmission System is a spot transmission system, where transmission is implemented by Balises.

Information transmitted from an Up-link Balise to the On-board Transmission Equipment is fixed or variable depending upon the application (Up-link data transmission).

Spot transmission is when a transmission path exists between the wayside equipment and the On-board Transmission Equipment at discrete locations. The information is provided to/from the train only as the Antenna Unit passes or stands over the corresponding Balise. The length of track on which the information is passed and received is limited to approximately one meter per Balise.

The Eurobalise Transmission System is intended for use in all of the levels of applications defined within the ERTMS/ETCS (called Level 0, Level 1, Level 2, Level 3, and Level NTC respectively).

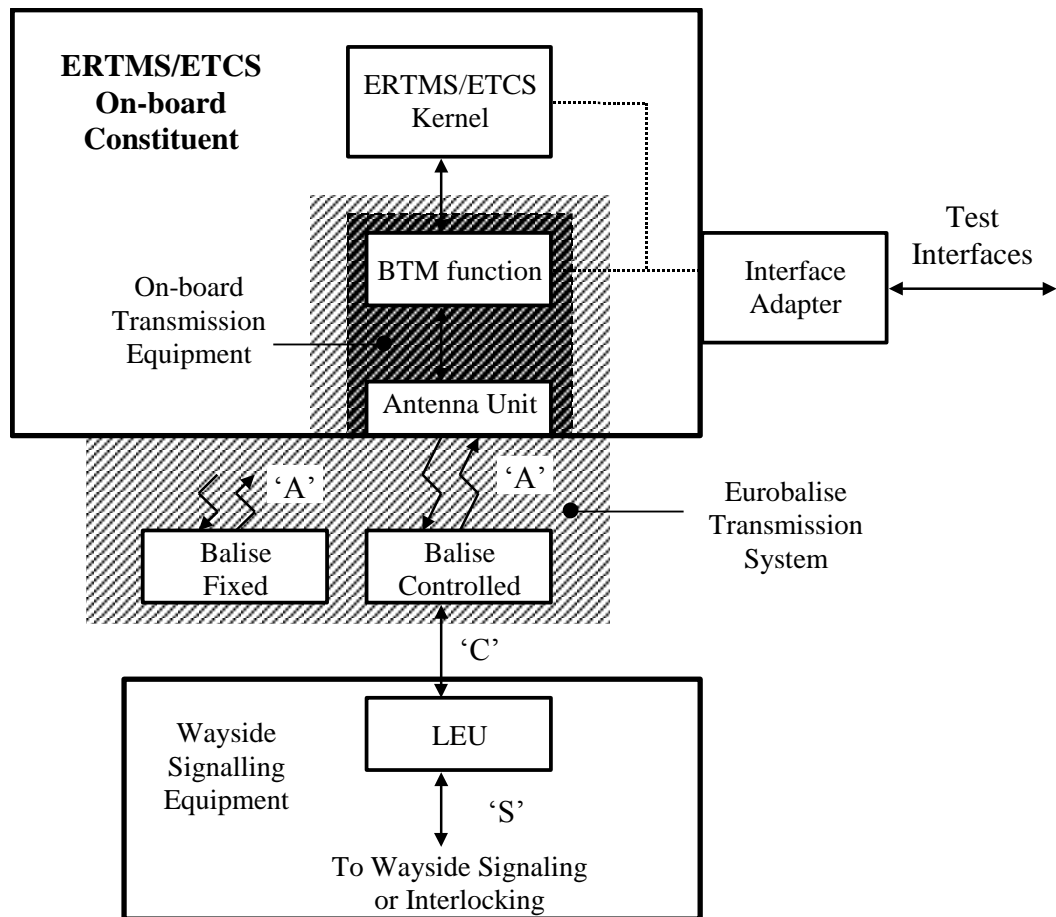
#### **4.1.2 Units and Functions**

The Eurobalise Transmission System consists of the (wayside) Balise and the On-board Transmission Equipment (that is part of the ERTMS/ETCS On-board constituent). Balises are of either fixed type or controlled type. The On-board Transmission Equipment consists of the Antenna Unit and the BTM function. The Wayside Signalling Equipment consists of the LEU and other external equipment involved in the wayside signalling process.

See Figure 1 of sub-clause 4.1.3.1 on page 21.

### 4.1.3 Interfaces

#### 4.1.3.1 Overall Configuration



**Figure 1: Eurobalise Transmission System, Interfaces**

The On-board Transmission Equipment communicates with the ERTMS/ETCS Kernel. The Balise communicates with the Wayside Signalling Equipment via Interface 'C'. The LEU (part of the Wayside Signalling Equipment) communicates with the wayside signalling or interlocking via (the non-standardised) Interface 'S'.

#### 4.1.3.2 External Interfaces

There is one preferred external standardised interface to and from the Eurobalise Transmission System:

- Interface 'C'** This is defined as the wayside interface between the Balise and the LEU. Telegrams are sent serially at the same data rate as in the air gap. This interface is split into the following sub-interfaces:
- Interface 'C1' This is an interface used for transmitting Up-link Eurobalise telegrams from the LEU to the Balise.
  - Interface 'C4' This is an optional interface used for inhibiting switching of telegrams in the LEU during a Balise passage.
  - Interface 'C6' This is an interface used for biasing the serial interface ('C1') input circuits of a controlled Up-link Balise (transmitted from the LEU).

There is also an Interface 'S' that is defined as the input to the LEU that interfaces the different national railway signalling equipment. This is not a part of the Eurobalise Transmission System.

Finally, there is an optional interface defined for programming the Fixed Telegram (for Fixed Balises) or the Default Telegram (for Controlled Balises) into the Balise using wire aided programming when applicable. This interface is denominated Interface 'C5'. Requirements are found in sub-clause 5.4 on page 74, but the interface is not within the scope of this specification.

#### 4.1.3.3 Internal Interfaces

There is one internal standardised interface within the Eurobalise Transmission System:

- Interface 'A'** This interface is split into the following sub-interfaces:
- Interface 'A1' This is an interface used for transmitting Up-link Eurobalise telegrams from the Up-link Balise to the Antenna Unit.
  - Interface 'A4' This is an interface used for transmitting the required power (Tele-powering) from the Antenna Unit to the Up-link Balise.

Additionally, there is an optional interface defined for programming the Fixed Telegram (for Fixed Balises) or the Default Telegram (for Controlled Balises) into the Balise using inductive programming when applicable. This interface is denominated Interface 'A5'. Requirements are found in sub-clause 5.4 on page 74, but the interface is not within the scope of this specification.

#### 4.1.3.4 Test Interfaces

There are three functional interfaces available for testing the Eurobalise Transmission System:

- Interface 'V1'** This is an interface used for testing various properties of the BTM function. In particular, it includes a specific sub-set designed for testing the Eurobalise Transmission System. The interface is not required to be integrated in the operational equipment. A company specific adapter (allowed to be external to the operational equipment) is used for providing the standardised interface.
- Interface 'V2'** This is an interface transmitting time and odometer information to the BTM function during testing. The interface is not required to be integrated in the operational equipment. A company specific adapter (allowed to be external to the operational equipment) is used for providing the standardised interface.
- Interface 'V4'** This interface comprises a pair of square wave signals giving the information of the longitudinal speed and the running direction of the Antenna Unit. This is used during testing, and is an alternative to using Interface 'V2' above. The interface is not required to be integrated in the operational equipment. A company specific adapter (allowed to be external to the operational equipment) is used for providing the standardised interface.

#### 4.1.4 Basic Functions

The Eurobalise Transmission System comprises the following basic functions:

On-board Transmission Equipment functionality:

- Generation of Tele-powering signal
- Assurance of Tele-powering signal level and Balise detectability
- Detection of Up-link Balises
- Up-link signal filtering and demodulation
- Physical Cross-talk protection
- Physical prevention of transmission of Side lobes, and/or management of Side lobe effects in data and in location
- Immunity to environmental noise
- Checking of Up-link incoming data with respect to Coding Requirements
- Detection of telegram type and decoding
- Extraction of user data
- Telegram Filtering
- Management of Up-link telegram switching within a Balise passage
- Time and odometer stamping of output data
- Support for Balise Localisation (for vital and non-vital purposes)
- Time and odometer data management
- Detection of Bit Errors
- Start-up tests

Optional On-board Transmission Equipment functionality:

- KER Up-link signal reception
- KER Up-link data checking and decoding
- Up-link KER data reporting
- Switching of Tele-powering mode (CW, toggling modulation)
- Logical Cross-talk protection management
- Self tests



Up-link Balise functionality:

- Reception of Tele-powering signal
- Up-link signal generation
- Data management
- Mode selection at start-up
- Limitation of the Up-link field (i.e., the Balise current)
- Support to programming and management of operational/programming mode
- Reception of data from Interface 'C'
- Control of I/O characteristics
- Cross-talk protection with other cables
- Generation of signal for Blocking of Telegram switching (optional)

#### **4.1.5 Management of Faults and Failures**

If the On-board Transmission Equipment is not able to detect Balises, it shall report this to the ERTMS/ETCS Kernel.

If there is a failure in Interface 'C', that makes transmission of the telegram from this interface impossible, the Balise shall send the Default Telegram which shall be transmitted to the On-board Transmission Equipment and handled as any other telegram.

## 4.2 Functional Requirements

### 4.2.1 Balise Tele-powering

The On-board Transmission Equipment shall provide a Tele-powering signal used for activating Up-link Balises. The vehicle mounted Antenna Unit shall transmit this signal to the Balise via Interface 'A'.

The On-board Transmission Equipment shall provide the desired Tele-powering Mode (CW, or the optional toggling modulation used for achieving interoperability with existing KER systems) on command from the ERTMS/ETCS Kernel.

The On-board Transmission Equipment shall be able to switch the Tele-powering signal on/off on command from the ERTMS/ETCS Kernel.

### 4.2.2 Up-link Data Transmission

#### 4.2.2.1 Information Flow

The Eurobalise Transmission System shall be capable of receiving information from the Wayside Signalling Equipment, and passing this information to the ERTMS/ETCS Kernel.

A Balise that is connected to an LEU shall transmit the received data transparently to Interface 'A'. Fixed, stand-alone Balises transmit fixed pre-programmed data during a train passage.

The BTM function shall make all the received data available to the ERTMS/ETCS Kernel, associated to the location information of the Balise passed over.

This shall be performed regardless of the direction of travel of the vehicle.

Under application conditions where a Balise Group consists of a number of Balises holding distributed data, the BTM function shall make available to the ERTMS/ETCS Kernel the data received in such a way that the order, in which data was received, can be reconstructed.

Information shall be correlated in such a way that the ERTMS/ETCS Kernel can identify that certain information is transmitted from a certain Balise, by associating the Balise data to the corresponding Balise location information.

#### 4.2.2.2 Filtering of Telegrams

Under circumstances where telegrams are switched while they are received by the On-board Transmission Equipment, then the BTM function should normally make the latest received telegram available to the ERTMS/ETCS Kernel once (the details for the criteria of the "latest received telegram" are depending on each manufacturer's specifications, but it shall be a safely received telegram with high quality during the transmission). In some cases, the telegram can be made available more than once, e.g., when passing over the Balise at low speed (see sub-clause 6.2.2.5 on page 113).

The information received from Balises should be filtered and analysed by the BTM function.

The BTM function is allowed to filter out incoming data, provided that a fully validated telegram is already received and decoded, and that the testability and delay requirements are fulfilled (see sub-clause 4.2.9 on page 33).

#### 4.2.2.3 Blocking of Telegram Switching

In order to improve the availability, an optional function of blocking the telegram switching is possible. This function requires that upon activation of transmission from track to train, the Balise shall signal to the LEU at the beginning of its start-up that it is being activated. If implemented, the LEU shall block telegram switching for a minimum time of 10 ms. The maximum blocking time is dependent on system requirements.

#### 4.2.2.4 Protection of Data

Data transmitted from track to train is considered safety critical. Protection of the data against air-gap noise effects and noise induced hazards in the receiving and transmitting equipment <sup>1</sup> shall be sufficient in order to ensure bit error detection to the extent that is specified by the coding requirements.

#### 4.2.2.5 Air-gap Data Transmission, Protocols and Procedures

Data transmission shall be performed without handshaking in Interface 'A'.

It is allowed to transmit sporadic bit sequences for diagnostic purposes in accordance with sub-clause 5.2.2.8.5 on page 66.

### 4.2.3 Intentionally Deleted

### 4.2.4 Location Reference

#### 4.2.4.1 Balise Centre Detection

The BTM function shall provide data that enables evaluation of the instant and/or location when the Antenna Unit reference mark crosses over the Balise reference mark, by analysing either the properties of the received Up-link signal, or data, or both.

#### 4.2.4.2 Time and Odometer stamping of the detected Balise Centre

The Eurobalise Transmission System shall provide data that enables evaluation of the location reference point for the Balise <sup>2</sup>, in time or position, depending on the quality of the time and odometer information that is available during each Balise passage. The information shall be made available to the ERTMS/ETCS Kernel. The instant in time or position on which the location reference is based shall originate from the ERTMS/ETCS Kernel.

#### 4.2.4.3 Train Direction Detection

Information about Balise sequences shall be passed on to the ERTMS/ETCS Kernel. The Eurobalise Transmission System shall provide information that enables the ERTMS/ETCS Kernel to evaluate the direction of the train on the basis of the reported sequence of passed Balises.

---

<sup>1</sup> Noise induced hazards are for example random disturbances leading to faults in the functions of the receiver.

<sup>2</sup> The location reference point for the Balise corresponds to the Balise reference mark.

## 4.2.5 Cross-talk Protection

### 4.2.5.1 Intrinsic Cross-talk Protection

The Eurobalise Transmission System shall not allow a valid telegram to be passed through, from a Balise located in a cross-talk protected zone, to the On-board ERTMS/ETCS Kernel, as defined in this specification.

The Eurobalise Transmission System shall ensure protection against cross-talk based on signal levels when all constraints regarding the installation requirements are considered. Additional cross-talk protection<sup>3</sup> is achieved by performing the ERTMS/ETCS level functions defined in UNISIG SUBSET-026.

The intrinsic cross-talk protection for the Eurobalise Transmission System is based on:

- The fulfilment of the Balise field conformity requirements (see sub-clause 5.2.2.5 on page 59).
- The fulfilment of the Balise input-to output characteristic (see sub-clause 5.2.2.6 on page 63).
- The installation requirements for Balises in proximity of extraneous cables or metallic masses (see sub-clauses 5.7.10.7 on page 103 and 5.7.10.4 on page 97).
- The electrical and company specific installation requirements for Balise controlling interface cables.
- The minimum value of the field strength threshold of the BTM function receiver,  $V_{th}$ , which is sufficiently high to correctly handle possible up-link signal received from an activated Balise in the cross-talk protected zone (see sub-clauses 6.2.2.1 on page 112 and 4.2.5.2.2 on page 30).
- The Tele-powering field generated by the On-board Antenna Unit, or generated by a second On-board Antenna Unit (possibly present in its vicinity on the same train), in the worst case Tele-powering field condition, reaching a Balise in a cross-talk protected zone, which is low enough not to activate it to a level that the Up-link signal is correctly received by the first Antenna Unit (see sub-clause 4.2.5.2.1 on page 30).

The worst case for the Balise input-to-output characteristic and field conformity shall be considered, see Figure 16 of sub-clause 5.2.2.6 on page 63, Figure 14 on page 60, and Figure 15 on page 61. The worst case situation for the On-board Transmission Equipment and for air-gap propagation shall be considered. However, in the case of two Antenna Units, only the Up-link protects from cross-talk.

Definition of the cross-talk protected zone (directions as per the reference axes according to sub-clause 4.5 on page 50) is according to the distances of Table 1 below.

---

<sup>3</sup> The Balises are in general configured in (linked or unlinked) Balise Groups with more than one Balise, or as single Balises with information linked to other Balises or sources of data. Verification of the group configuration data and of the linking information, performed by the ERTMS/ETCS system level functions, constitutes an additional protection against cross-talk.

Type of cross-talk	Involved equipment	Zone where cross-talk shall not occur
Lateral (direction Y)	One Balise and one Antenna Unit.	1.4 m or more between the Balise and the Antenna Unit (related to the Z reference marks).
Lateral (direction Y)	One or two Balises and two Antenna Units.	3.0 m or more between the cross-talk Balise and the interfered Antenna Unit (related to the Z reference marks).
Vertical (direction Z)	One Balise and one Antenna Unit.	4.8 m, or more, related to the X and Y reference marks.
Longitudinal (direction X)	Two Balises and one Antenna Unit. 2.6 m or more between two consecutive Standard Size Balises, and 2.3 m or more between two Reduced Size Balises (related to the Y reference marks). 2.6 m applies if combinations of Balise sizes are applicable.	Any location of the Antenna Unit along the same track as the Balises. <sup>4</sup>
Longitudinal (direction X)	One Balise and two Antenna Units. 4.0 m or more between two Antenna Units.	Any location of the Antenna Units along the same track as the Balise. <sup>5</sup>

**Table 1: Definition of Cross-talk Protected Zone**

Longitudinal cross-talk is mainly related to reliability cross-talk. It is a safety-related aspect that the On-board constituent is enabled to correctly determine the order (e.g., sequence in time and/or position) of the passed Balises, and that erroneous positioning (see sub-clause 4.2.10.2 on page 35) shall not occur.

The configurations (including the number of units) of Table 1 are considered being worst cases from a cross-talk standpoint.

<sup>4</sup> In general, it is assumed that the attention is focused to the near vicinity of the Balises in question. Therefore, it is assumed that the Antenna Unit is positioned anywhere within the zone limited by 1.3 m before the first Balise and 1.3 m after the second Balise (related to the Z reference marks of the Balises).  
From a reliability cross-talk standpoint, the On-board Balise Equipment shall not report the telegram of a Balise more than 1.3 m away from its Y reference marks (in X direction). See UNISIG SUBSET-026.

<sup>5</sup> In general, it is assumed that the attention is focused to the near vicinity of the Balise in question. Therefore, it is assumed that the Balise is positioned anywhere within the zone limited by 1.3 m before the first Antenna Unit and 1.3 m after the second Antenna Unit (related to the Z reference marks of the Antenna Units).

Other cross-talk related conditions:

Object	Requirement
Cables in the track.	Cables shall be outside the protected area according to Figure 29 and Figure 30 of sub-clause 5.7.10.1 on page 94 (except for approved loop cables according to Figure 39 of sub-clause 5.7.10.7.1 on page 103). The installation of Balises in the proximity of cables, or the installation of cables in the proximity of Balises shall fulfil the requirements stated in sub-clause 5.7.10.7 on page 103.
Metallic reflectors on the vehicle.	Metallic objects shall be outside the metal free area of the Antenna Unit, as specified by the manufacturer.
Metallic reflectors in the track.	Metallic objects on the ground shall be outside the protected area for the Balise according to Figure 29 and Figure 30 of sub-clause 5.7.10.1 on page 94.
Guard Rails	See sub-clause 5.7.10.4 on page 97.

**Table 2: Other Cross-talk conditions**

#### 4.2.5.2 Up-link Data Communication

##### 4.2.5.2.1 One Balise, one Antenna Unit

The total attenuation from the Antenna Unit Tele-powering to the received signal level of the Up-link signal shall under the worst case condition (i.e., highest possible efficiency according to Figure 16 of sub-clause 5.2.2.6 on page 63, and in presence of nearby cables, guard rails, and debris) be more than the ratio between the maximum Tele-powering signal level in the Antenna Unit and the minimum value of the Up-link receiver threshold field strength  $V_{th}$ .

##### 4.2.5.2.2 One Balise, two Antenna Units

A cross-talking Balise may be powered by another vehicle. The received signal level from the Balise shall under the worst case condition (i.e., highest possible output current  $I_{u3}$  according to Figure 16 of sub-clause 5.2.2.6 on page 63, and in presence of nearby cables, guard rails, and debris) be less than the minimum value of the field strength threshold of the BTM function receiver  $V_{th}$ .

#### 4.2.5.3 Intentionally Deleted

## **4.2.6 Compatibility with existing systems**

### **4.2.6.1 General**

The requirement on compatibility has to be regarded in a general sense, mostly applicable to the adopted transmission technology. This requirement will have to be considered on the basis of the concerned Railway system specification, and on the applicable Eurobalise test procedures. The requirement of compatibility is explicitly intended for the earlier generation of Balises using the Magnetic Transponder Technology, and the same air-gap signal frequencies as the Eurobalise system. As for the compatibility with other systems working at different frequencies, the issue of compatibility will have to be considered case by case considering the overall Railway system.

### **4.2.6.2 Up-link Data Communication**

The Eurobalise Transmission System shall be compatible with any existing railway systems, see examples in clause D3 of Annex D on page 142. Relevant conditions shall be defined case by case.

### **4.2.6.3 Intentionally Deleted**

## **4.2.7 Interoperability with existing KER Systems**

The On-board Transmission Equipment should optionally be able to read the data coming from the KVB, Ebicab, and RSDD Balises. This requires that the On-board Transmission Equipment is transmitting a 27 MHz toggling 50 kHz modulated Tele-powering signal. The BTM function shall be informed by the ERTMS/ETCS Kernel at start-up, and whenever there is a change of operating conditions, whether it shall transmit a 27 MHz CW signal or a 27 MHz signal modulated by a toggling 50 kHz Tele-powering signal. .

The Eurobalise responds equally when being activated by either a 27 MHz CW signal, or a 27 MHz signal with a toggling 50 kHz modulation (see sub-clause 5.2.2.9 on page 67).

The On-board Transmission Equipment should transmit 27 MHz CW at train speeds above 350 km/h. <sup>6</sup>

---

<sup>6</sup> The reason for transmitting only 27 MHz CW at train speeds above 350 km/h is that the start-up time for the Balise is less when it receives CW compared to the toggling Tele-powering signal. Additionally, the KER systems are not specified for speeds above 350 km/h, which means that there is no use for the toggling signal at these high speeds. The conclusion is that the CW signal is recommended at these high speeds.

## 4.2.8 Quality of the Data Transmission Channel

### 4.2.8.1 Data Capacity

The following telegrams shall be possible at a maximum vehicle speed of 500 km/h:

- 1) 341 bit telegram.
- 2) 1023 bit telegram.

Mixing of Balises, and transmitting different telegram lengths, shall be possible on the same line. Please observe the constraints of sub-clause 5.2.2.3 on page 57.

The Balise shall be able to receive data from an LEU at a distance of at least 500 m (see sub-clause 5.3.1 on page 68). Sub-clause 5.3 on page 68 specifies the needed requirements for achieving interchangeability for distances of up to 500 m. Longer distances than 500 m (for example 5 km) can be achieved by the individual supplier.

### 4.2.8.2 Transmission Bit Errors

The BER (Bit Error Rate) in the central area of the contact length of each Balise should be less than  $10^{-6}$ .<sup>7</sup> Bit errors in the railway environment could occur as burst errors, random bit errors, and bit slip/insertion. The BER shall be such that the Eurobalise Transmission System fulfils the RAMS requirements. The requirement is an overall requirement for a complete system.

The BTM function shall detect (and possibly correct, to a limited extent) bit errors in Up-link transmission.

### 4.2.8.3 Code Protection

Data and telegram structures shall be protected against possible noise effects in the air-gap, and against noise induced hazards in the receiving and transmitting equipment by suitable telegram coding algorithms as described by the coding requirements (see sub-clause 4.3 on page 36).

The same coding algorithms shall protect data and telegram structures against noise and failures during transmission via the serial link connecting the LEU with the Balise (there is no bit error detection in the Balise).

Data and telegram structures shall be protected against noise or failures in the communication between the BTM functions and the ERTMS/ETCS Kernel by different coding algorithms.

---

<sup>7</sup> The hint on BER target may be individually verified on a voluntary basis, and is not a firm requirement. Moreover, it can not be verified in any harmonised interface. This property only partly addresses aspects related to the overall system requirements of section 4.4.4.





The distance between two clusters of Balises shall be at least  $d_c$ .

$$d_c = T_N \cdot v_{\text{line}} \text{ [m]}$$

$d_c$  = The distance between two clusters of Balises, i.e., from 1.3 m after the last Balise in the first cluster to 1.3 m before the first Balise in the second cluster.

$v_{\text{line}}$  = The Maximum Permitted Speed in m/ms.

$N$  = The last Balise in a cluster of Balises. If  $\Delta t_{n-1} = 0 \Rightarrow n = N \Rightarrow T_n = T_N$ ,  $N \leq 8$ .

At low speeds of the train, an estimated location reference (with lower confidence than the location reference information delivered after the Balise passage) should be given in relation with the Up-link data after the maximum time delay (a time-out) defined in sub-clause 6.2.2.5 on page 113. See also sub-clause 4.2.10 on page 35.

## 4.2.10 Location Reference Accuracy

### 4.2.10.1 General

The Eurobalise Transmission System shall evaluate the location for the Balise, using the available time and odometer information, and make this information available to the ERTMS/ETCS Kernel. This delivered information includes the error in the time and odometer information, which is not considered in the following.

### 4.2.10.2 Accuracy for vital purposes

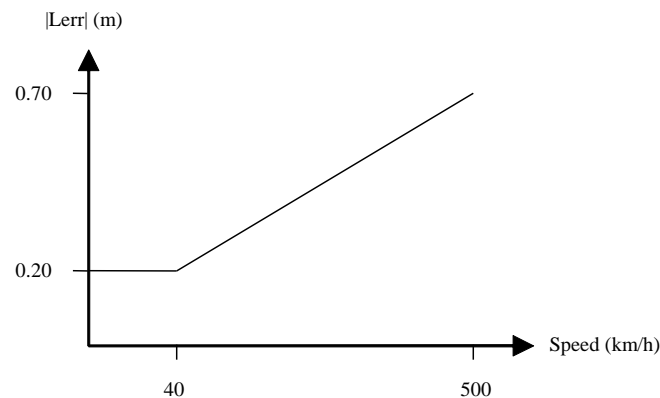
The location accuracy shall be within  $\pm 1$  m for each Balise, when a Balise has been passed.

When applicable, the location accuracy in the preliminary location reference, delivered after the reporting period defined in sub-clause 6.2.2.5 on page 113 during the Balise passage, shall be within  $\pm 1$  m.<sup>8</sup>

### 4.2.10.3 Accuracy for non-vital purposes

The location accuracy shall fulfil the following Figure 3 with a confidence interval of 0.998 after the Balise passage.

Figure 3 below specifies the error  $|L_{err}|$  as function of the speed.  $|L_{err}|$  is the maximum error in measured Balise position relative to the physical centre of the Balise. The error in the external odometer references is not included.<sup>9</sup>



**Figure 3: Error in position of the Balise centre relative to the odometer value**

The figure above may be expressed as<sup>10</sup>:

$$|L_{err}| = \begin{cases} 0.20 \text{ m} & 0 \text{ km/h} < v < 40 \text{ km/h} \\ 1.1 \cdot 10^{-3} \cdot v + 0.15 \text{ m} & 40 \text{ km/h} \leq v \leq 500 \text{ km/h} \end{cases}$$

<sup>8</sup> Each manufacturer shall specify the needed performance related to the received odometer and time information to meet this requirement.

<sup>9</sup> Preferably, the vertical component of the Up-link magnetic field is used for this purpose. Therefore particular demands on conformity and stability apply for this signal both in static and dynamic conditions.

<sup>10</sup> Each manufacturer shall specify the needed performance related to the received odometer and time information to meet this requirement.

## 4.3 Coding Requirements

### 4.3.1 Introduction

#### 4.3.1.1 Overview

The key features of the telegram format are the following:

- Two compatible telegram lengths, 1023 and 341 respectively.
- A large number of unrestricted information bits, 830 and 210, respectively (some of these bits will be reserved for higher levels of the telegram transmission system such as the separation of Up-link and Down-link telegrams.)
- Provable safety against various types of transmission errors.
- Inversion of all bits of the telegram is always recognised by the decoder.
- The transmission needs not start (or end) at the beginning of a telegram. The detection procedure is completely transparent with respect to cyclic shifts of a telegram.
- Support for compatibility with unknown future format variations.

The telegram format allows for quantitative evaluation of the effect of random bit errors, burst errors, bit slips and bit insertions, and all combinations thereof, with particular attention to the potential problems of telegram change and format misinterpretation (long as short and vice versa).

Note that any safety related evaluation is valid only with respect to some specific receiver. Receivers other than that of sub-clause 4.3.4.1 on page 41 may be used, provided that a complete safety related evaluation can be given.

#### 4.3.1.2 Telegram Format

The telegram format is described with respect to Figure 4. There are two versions, a long format of length,  $n_L = 1023 (= 93 \cdot 11)$ , and a short format of length  $n_S = 341 (= 31 \cdot 11)$ . The bits of the telegram are denoted  $b_{n-1}, b_{n-2}, \dots, b_1, b_0$  (with  $n = n_L = 1023$  or  $n = n_S = 341$ ). The numbering with descending indices (from left to right) is chosen such that “left” and “right” conform with Figure 4. The order of transmission is from left to right (but need not begin with the leftmost bit  $b_{n-1}$ ).

Shaped Data 83·11=913 or 21·11=231 bits	cb 3 bits	sb 12 bits	esb 10 bits	Check bits 85 bits
--	--------------	---------------	----------------	-----------------------

**Figure 4: The telegram format**

The telegram begins with a block of “shaped data”, which contains the user data “scrambled” and “shaped” as described in sub-clauses 4.3.2.2 on page 37 and 4.3.2.3 on page 38. In the long format, this block consists of 913 bits (83 11-bit words), i.e., the bits  $b_{1022} \dots b_{110}$ . In the short format, the block consists of 231 bits (21 words), i.e.,  $b_{340} \dots b_{110}$  (from now on and unless stated otherwise, a “word” consists of 11 bits). Each word contains 10 user bits. A long telegram thus contains 830 user bits and a short telegram contains 210 user bits.

The three bits  $b_{109} \dots b_{107}$  are “control bits” (cb). The first control bit,  $b_{109}$ , is the “inversion bit”, which shall be set to zero. The other two control bits,  $b_{108}$  and  $b_{107}$ , are not currently used and are intended for future format variations. For the present format, these spare bits shall be set to  $b_{108}=0$  and  $b_{107}=1$ . The next 12 bits,  $b_{106} \dots b_{95}$ , are “scrambling bits” (sb). They store the initial state of a scrambler that operates on the data bits before shaping, see sub-clause 4.3.2.2 on page 37. The following 10 bits,  $b_{94} \dots b_{85}$ , are “extra shaping bits” (esb). They are used to enforce the shaping constraints on the check bits independent of the scrambling. They are disregarded by the receiver (except that the shaping constraints are checked). The last 85 bits,  $b_{84} \dots b_0$ , are “check bits”, and comprise 75 parity bits of the error detecting code and 10 bits for synchronisation.

## 4.3.2 Encoding Requirements

### 4.3.2.1 General

The following notation is used. With any binary  $n$ -tuple  $v = [v_{n-1}, v_{n-2}, \dots, v_1, v_0]$ , we associate the binary polynomial  $v(x) := v_{n-1}x^{n-1} + v_{n-2}x^{n-2} + \dots + v_1x + v_0$  (in more mathematical terms, a “bit” is an element of the finite field  $\text{GF}(2)$ , and a “binary polynomial” is an element of the ring  $\text{GF}(2)[2]$ ). For any two binary polynomials  $c(x)$  and  $d(x)$ ,  $\text{Rc}(x)[d(x)]$  denotes the remainder of the division of  $d(x)$  by  $c(x)$ . That is, the unique polynomial  $r(x)$  of degree less than the degree of  $c(x)$  such that  $d(x) = q(x)c(x) + r(x)$ , for some polynomial  $q(x)$  (all additions are to be performed mod 2).

### 4.3.2.2 Scrambling

Scrambling shall be done in a way to get the same result as from the following steps:

1. Replacement of the first ten user bits by a function of all user bits.
2. Computation of a 32-bit integer  $S$  from the 12 scrambling bits.
3. The actual scrambling, using a 32-bit linear feedback shift register with initial state  $S$ .

The purpose of step 1 (and of the specific formulation of step 3) is to make sure that changing a single user bit gives a completely different scrambled sequence.

**Step 1:** Let  $m=830$  for the long format and  $m=210$  for the short format. Let  $u_{m-1}, u_{m-2}, \dots, u_0$  be the user bits. The user bits are partitioned, from left to right, into  $k$  10-bit blocks,  $U_{k-1} = (u_{m-1} \dots u_{m-10})$ ,  $U_{k-2} = (u_{m-11} \dots u_{m-20})$ ,  $\dots$ ,  $U_0 = (u_9 \dots u_0)$ , with  $k=83$  for the long format and  $k=21$  for the short format. A new sequence  $U'_{k-1}, U'_{k-2}, \dots, U'_0$  of 10-bit words is formed that differs only in the first word:  $U'_i = U_i$  for  $i=0 \dots k-2$  and

$$U'_{k-1} = \sum_{i=0}^{k-1} U_i \text{ mod } 2^{10}, \quad (1)$$

where all 10-bit blocks are interpreted as integers with most significant bit (MSB) to the left. The sequence  $U'_{k-1}, \dots, U'_0$  is converted back to a bit stream  $u'_{m-1}, \dots, u'_0$ , which agrees with  $u_{m-1}, \dots, u_0$  except for the first ten bits  $u'_{m-1}, \dots, u'_{m-10}$ .

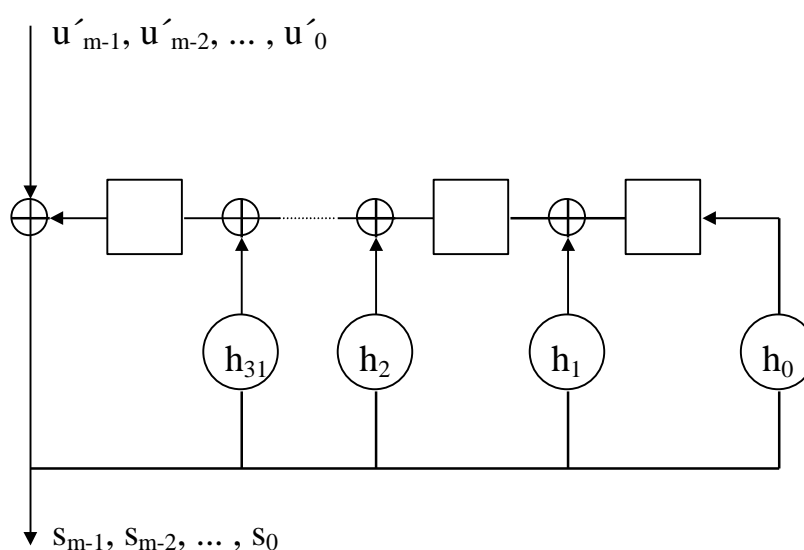
**Step 2:** The 12 scrambling bits (sb)  $b_{106} \dots b_{95}$  are considered as an integer, with most significant bit (MSB)  $b_{106}$  and least significant bit (LSB)  $b_{95}$ ,  $B = b_{106} \cdot 2^{11} + \dots + b_{96} \cdot 2 + b_{95}$ . The 32-bit integer  $S$  is defined as

$$S = (2801775573 \cdot B) \text{ mod } 2^{32}. \quad (2)$$

Note that  $2801775573 = 69069^3 \text{ mod } 2^{32}$ ; the latter number is a common choice for this type of random number generator.

**Step 3:** Use the shift register circuit of Figure 5, where the squares are delay cells, and the plus signs denote the exclusive-OR operation. The coefficients  $h_{31}$ ,  $h_{30}$ ,  $h_{29}$ ,  $h_{27}$ ,  $h_{25}$ , and  $h_0$  are equal to 1 (connected through). All other coefficients are 0 (no connection). The total number of delay cells is 32. The binary representation of  $S$  is loaded as initial state in the shift register of Figure 5 (with MSB to the left). Then the circuit is clocked  $m-1$  times, with input  $u'_{m-1}, \dots, u'_0$ , to generate the scrambled bits  $s_{m-1}, s_{m-2}, \dots, s_0$  (the first output,  $s_{m-1}$ , is read before the first clock).

In polynomial notation, the circuit of Figure 5 performs, at each clock, the operation  $\sigma(x) \mapsto R_{h(x)}[x \cdot \sigma(x) + u_i x^{32}]$ , where  $\sigma(x) = \sigma_{31}x^{31} + \dots + \sigma_1x + \sigma_0$  is the contents of the shift register (with  $\sigma_0$  to the right), where  $h(x) = x^{32} + x^{31} + x^{30} + x^{29} + x^{27} + x^{25} + 1$ , and where  $u_i$  is the current input ( $i=m-1 \dots 0$ ).



**Figure 5: Scrambling**

#### 4.3.2.3 The 10-to-11-Bit Transformation

The scrambled bits are partitioned into blocks of 10 bits each, in the direction of descending indices (the first block thus consists of the bits  $s_{m-1}, s_{m-2}, \dots, s_{m-10}$ , with  $m$  as above). There are 83 such blocks in the long format and 21 in the short format. Each such block shall be transformed into an 11-bit word by a substitution table. The 1024 substitution values (11-bit words) are listed in clause B2 of Annex B on page 137 (in the order of increasing magnitude). The substitution rule is that the block, considered as an integer  $i$  (between 0 and 1023, with MSB to the left), is transformed into the  $i$ -th word in the list (where the words are numbered beginning with 0). The substitution word for  $i+1$  is thus always larger (as an integer) than the substitution word for  $i$ .

The words are listed in clause B2 of Annex B on page 137.

#### 4.3.2.4 Computing the Check Bits

After the scrambling and the transformation of sub-clauses 4.3.2.2 on page 37 and 4.3.2.3 on page 38, and by some choice of the “extra shaping bits” (esb)  $b_{94}\dots b_{85}$ , the bits  $b_{n-1}\dots b_{85}$  of the candidate telegram are fixed. It remains to compute the check bits  $b_{84}\dots b_0$ . In polynomial notation (as introduced at the beginning of sub-clause 4.3.2.1 on page 37), the check bits shall be defined as follows:

$$b_{84}x^{84} + \dots + b_1x + b_0 = R_{f(x)g(x)}[b_{n-1}x^{n-1} + \dots + b_{85}x^{85}] + o(x), \quad (3)$$

where the polynomials  $f(x)$ ,  $g(x)$ , and  $o(x)$  depend on the format. For the long format, the following equations should be used:  $f(x)=f_L(x)$ ,  $g(x)=g_L(x)$ , and  $o(x)=g_L(x)$ :

$$f_L(x) = x^{10} + x^9 + x^7 + x^6 + x^4 + x^3 + x^2 + x + 1$$

$$g_L(x) = x^{75} + x^{73} + x^{72} + x^{71} + x^{67} + x^{62} + x^{61} + x^{60} + x^{57} + x^{56} + x^{55} + x^{52} + x^{51} + x^{49} + x^{46} + x^{45} + x^{44} + x^{43} + x^{41} + x^{37} + x^{35} + x^{34} + x^{33} + x^{31} + x^{30} + x^{28} + x^{26} + x^{24} + x^{21} + x^{17} + x^{16} + x^{15} + x^{13} + x^{12} + x^{11} + x^9 + x^4 + x + 1.$$

For the short format, the following equations should be used:  $f(x)=f_S(x)$ ,  $g(x)=g_S(x)$ , and  $o(x)=g_S(x)$ :

$$f_S(x) = x^{10} + x^8 + x^7 + x^5 + x^3 + x + 1$$

$$g_S(x) = x^{75} + x^{72} + x^{71} + x^{70} + x^{69} + x^{68} + x^{66} + x^{65} + x^{64} + x^{63} + x^{60} + x^{55} + x^{54} + x^{49} + x^{47} + x^{46} + x^{45} + x^{44} + x^{43} + x^{42} + x^{41} + x^{39} + x^{38} + x^{37} + x^{36} + x^{34} + x^{33} + x^{32} + x^{31} + x^{30} + x^{27} + x^{25} + x^{22} + x^{19} + x^{17} + x^{13} + x^{12} + x^{11} + x^{10} + x^6 + x^3 + x + 1.$$

The polynomials  $g_L(x)$  and  $g_S(x)$  satisfy

$$R_{g_L(x)}[g_S(x) \cdot (x^{682} + x^{341} + 1)] = 0, \quad (4)$$

which implies that the tree-fold repetition of a short telegram satisfies the parity check of the long format.

#### 4.3.2.5 Testing Candidate Telegrams

##### 4.3.2.5.1 General

Every telegram shall satisfy all conditions below. As described in sub-clause 4.3.2.3 on page 38, a candidate telegram that does not satisfy all these conditions shall be rejected; a new candidate may then be obtained by either changing the extra shaping bits (which affects only the check bits), or by changing the scrambling bits (which affects the whole telegram).

All the conditions below shall also hold “wrap-around”, i.e., for cyclically repeated telegrams. All indices are tacitly assumed to be reduced modulo  $n$  ( $=1023$  or  $341$  for the long and the short format, respectively).

Recall that an 11-bit word is called “valid” if it is one of the 1024 substitution values of sub-clause 4.3.2.3 on page 38.

#### 4.3.2.5.2 Alphabet Condition

Any 11-bit word  $b_{i-1}...b_{i-11}$  such that  $i$  is a multiple of 11 shall be valid.

Clearly, this condition is automatically satisfied in the shaped-data part of the telegram. However, the alphabet condition applies to all parts of the telegram.

#### 4.3.2.5.3 Off-Synch-Parsing Condition

This condition tests sequences of 11-bit words:  $(b_{i-1}...b_{i-11})$ ,  $(b_{i-12}...b_{i-22})$ ,  $(b_{i-23}...b_{i-33})$ , ... with  $i$  *not* a multiple of 11. It imposes a limit on the number of consecutive valid words within such sequences.

If  $i+1$  or  $i-1$  is a multiple of 11, the length of the longest run of consecutive valid words shall not exceed 2 (two). Otherwise, if it is not a multiple of 11, the length of the longest run of consecutive valid words shall not exceed 10 (ten) for long telegrams and 6 (six) for short telegrams.

None of these conditions is automatically satisfied in any part of the telegram. However, the substitution table “helps” in the case where  $i+1$  or  $i-1$  is a multiple of 11, see sub-clause 4.3.2.3 on page 38.

#### 4.3.2.5.4 Aperiodicity Condition for Long Format

This condition applies only to the long format. It ensures that no part of a long telegram may be mistaken as a short telegram, even in the presence of noise and bit slips, by testing the Hamming distance between two sequences of 11-bit words that are separated by about 341 bits.

For every  $i$  that is a multiple of 11:

- the Hamming distance between  $b_{i-1}...b_{i-22}$  and  $b_{i-341-1}...b_{i-341-22}$  shall be at least 3;
- for each  $k = +1, -1, +2, -2, +3$  and  $-3$ , the Hamming distance between  $b_{i-1}...b_{i-22}$  and  $b_{i-341-k-1}...b_{i-341-k-22}$  shall be at least 2.

#### 4.3.2.5.5 Under-sampling Condition

Under-sampling by 2, i.e., permuting a telegram into  $b_{n-2}, b_{n-4}, \dots, b_1, b_{n-1}, b_{n-3}, \dots, b_2, b_0$ , results in another code word in the cyclic code and is thus not detectable by checking the parity bits. Since it is plausible that such a transformation can be caused by a hardware defect, each telegram is tested to make sure that such a transformed code word violates the Alphabet Condition.

Let  $v_j = b_{j,2k}$ ,  $j=0...n-1$  (under-sampling by a factor of  $2^k$ ). For  $k=1, 2, 3, 4$  and for any  $i$ , the length of the longest run of valid words in the sequence  $(v_{i-1}...v_{i-11})$ ,  $(v_{i-12}...v_{i-22})$ ,  $(v_{i-23}...v_{i-33})$  shall not exceed 30.

In other words, no under-sampled short telegram and no length-341 segment of an under-sampled long telegram may satisfy the Alphabet Condition with arbitrary word boundaries.

### 4.3.3 Telegram Switching

Usually, a telegram is repeated “forever”, i.e., for the whole duration of a train passage:  $b_{n-1}, \dots, b_0, b_{n-1}, b_{n-2}, \dots$ . If the transmitter switches to a new telegram, a string of all zeros or a string all ones shall be inserted between the last transmitted bit of the old telegram and the first transmitted bit of the new telegram (the “last” and “first” transmitted bit can be any bit in the telegram and need not be  $b_0$  and  $b_{n-1}$ , respectively).

The length of this inserted string shall be between 75 and 128 bits.



## 4.3.4 Decoding Requirements

### 4.3.4.1 Basic Receiver Operation

The receiver comes in two (very similar) versions, one for the long format (with  $n=1023$ ) and one for the short format ( $n=341$ ).

Any used receiver shall be at least as good as the following one:

1. Consider a window of  $n+r$  consecutive received bits (long format:  $r=77$ ; short format:  $r=121$ ). If the window has already been shifted over 7500 bits, set  $r=n$ .
2. Is the parity-check satisfied, i.e., are the first  $n$  bits (considered as a polynomial) divisible by  $g(x)$ ? If not, shift window and go to 1.
3. Do the  $r$  extra bits (rightmost in window) coincide with the first  $r$  bits (leftmost in window)? If not, shift window and go to 1.
4. Find the beginning (position of  $b_{n-1}$ ) of the telegram with the help of  $f(x)$ . See sub-clause A1.2.1 of Annex A on page 132, (if  $Rf(x)[v(x)]$  is an “impossible” value, go to 1).
5. Are all 11-bit words ( $b_{n-1}...b_{n-11}$ ), ( $b_{n-12}...b_{n-22}$ ), ..., ( $b_{10}...b_0$ ) valid? If not, shift window and go to 1.
6. At this point, the telegram is considered safe.
7. Is the inversion bit  $b_{109}=1$ ? If yes, see sub-clause 4.3.4.2 below.
8. Check the other two control bits. If  $b_{108}=1$  or  $b_{107}=0$ , abort with the message “unknown telegram format”.
9. Invert the 10-to-11-bit transformation.
10. De-scramble.
11. Output the user bits and the original state of the inversion bit ( $b_{109}$ ).

See also additional information in sub-clause A1.2.2 of Annex A on page 133.

### 4.3.4.2 Check of the Control Bits

Every receiver shall check the “control bits” (cb). If the inversion bit  $b_{109}$  is found to be 1, all the received bits could be used after inversion, or could be rejected by the BTM function.

In both cases a message “inversion bit set” shall be sent to the ERTMS/ETCS Kernel.

The other two “control bits”  $b_{108}$  and  $b_{107}$  shall be checked (after the telegram is decoded and considered valid). If they are not found to be 0 and 1 respectively, the receiver shall announce the message “unknown telegram format”.

### 4.3.4.3 Check of the Under-sampling Condition

The receiver shall not check the Under-sampling Condition of sub-clause 4.3.2.5.5 on page 40 (the reason is that future format variations designed, e.g., for real-time encodability may not be able to enforce that condition).

#### 4.3.4.4 Check of the Extra bits

Note, that the basic receiver of sub-clause 4.3.4.1 requires a number of extra bits (beyond the length of the telegram) to be error-free. The requirement is 77 bits for the long, and 121 bits for the short format. Any safety related receiver shall at least consider this amount of extra bits.

### 4.4 RAMS Requirements

#### 4.4.1 General

Within this sub-clause (4.4), the term “Transmission System” is used as a short form for “Balise Location and Transmission System”.

A RAMS Program (RAM Program and Safety Plan) shall address issues related to RAMS management, reliability, availability, maintainability, and safety, in accordance with the applicable definitions of EN 50126.

In general, the minimum operational lifetime should be 20 years. In particular the minimum operational lifetime for the fixed data Balise should be 30 years.

#### 4.4.2 Top level functionality

Table 3 below defines the top-level functionality of the constituents of the Transmission System in terms of basic functions. Related hazards are found in sub-clause 4.4.6.3 on page 46.

No.	Function Description	Related hazards
F1	Balise Detection	H1, H2, H3
F2	Transmit protected data from wayside devices to the intended train devices	H4, H5, H6, H9
F3	Provide data used for localisation of the train	H7
F4	Allow understanding of the travelling direction of the train	H8

**Table 3: List of basic functions**

#### 4.4.3 Reliability

The MTTF (Mean Time To Failure) for a given constituent of the Transmission System might fluctuate with the time. The reliability targets concern the mean MTTF value over the operational lifetime.

The constituents of the Transmission System shall operate so as to ensure that reliability cross-talk from, and to, adjacent tracks does not adversely affect the overall reliability. Reliability cross-talk is defined as the disturbing effect on the correct transmission of data, such that correct transmission is unattainable.

#### 4.4.4 Availability

The Balise Detect function implicitly measures the air-gap noise levels, and effectively constitutes an EMC level supervision. When the EMC level is above a level that ensures the required Balise transmission performance, then the On-board Transmission Equipment may perform Balise Detect. Thus, this implicitly includes EMC supervision, and triggers a vital fallback function (i.e., the Balise Detect functionality). The false alarm rate for the Balise Detect functionality is affecting the availability that must comply with the overall system level requirements.

The following specific availability targets should be fulfilled:

- A mean figure of  $10^6$  Balise passages with error free telegrams delivered by the On-board Transmission Equipment to the ERTMS/ETCS Kernel should be ensured. This applies within the entire specified range of environmental conditions and train speeds.
- The On-board Transmission Equipment should not erroneously report to the ERTMS/ETCS Kernel that it has detected a Balise more often than  $10^{-3}$  times per hour.<sup>11</sup>

#### 4.4.5 Intentionally Deleted

#### 4.4.6 Safety

##### 4.4.6.1 General

For the constituents of the Transmission System, a Safety Plan shall be agreed. It shall be implemented, reviewed, and maintained throughout the lifecycle of the system. The following issues shall be considered:

- Identification of the safety related functions for the system, and definition of the corresponding integrity levels.
- Applicable analysis methods.
- Identification and analysis of all possible hazards.
- Assessment of risks.
- Criteria for risk mitigation and tolerability.
- Safety verification, validation, and assessment.

All work pertaining to Safety shall comply with the standards:

- EN 50126
- EN 50128
- EN 50129

---

<sup>11</sup> This can occur without faults in the equipment (e.g., due to disturbance).

## 4.4.6.2 Safety related functionality

### 4.4.6.2.1 Introduction

The functionality defined by Table 3 on page 42 is categorised safety related.

No single independent constituent failure shall result in a hazard rate exceeding the figures specified in sub-clauses 5.5.5.2 on page 81 and 6.4.5.2 on page 120. Secondary or dependent failures that occur as a result of an initial failure shall also be considered in combination with that initial failure.

### 4.4.6.2.2 Balise Detection

The ability to detect Balises is considered safety-critical, and constitutes a fall-back functionality in case the transmitted telegram can not be read by the On-board Transmission Equipment. The detection function is given as an indication to the ERTMS/ETCS Kernel.

Information about wayside failures shall be passed on to the ERTMS/ETCS Kernel. This includes transmitting a Balise Detect without an accompanying valid telegram.

### 4.4.6.2.3 Transmission of protected data

Data and telegram structures shall be protected against possible noise effects in the air-gap and noise induced hazards in the receiving and transmitting equipment, by telegram coding algorithms, as defined in sub-clause 4.3 on page 36.

The same coding algorithms shall protect data, and telegram structures, against noise and failures during transmission in the Balise controlling interface connecting the LEU with the Balise (there is no bit error detection in the Balise). However, the Balise shall switch to its Default Telegram if the data quality falls below an acceptable level within a maximum allowed time (the actual level is manufacturer dependent).

Data transmitted from track to train is considered safety-critical. Protection of the data against air-gap noise effects and noise-induced hazards in the receiving and transmitting equipment<sup>12</sup> shall be sufficient in order to ensure bit error detection to the extent that is specified in sub-clause 4.3 on page 36.

The constituents of the Transmission System shall ensure protection against cross-talk based on signal levels when all constraints regarding the installation requirements are considered. The cross-talk protection can additionally be based on the reception of at least two Balises that are logically linked to each other. This protection, and the logical linking of these Balises, is performed on ERTMS/ETCS system level.

Information about wayside failures shall be passed on to the ERTMS/ETCS Kernel. This includes transmitting a Default Telegram.

The constituents of the Transmission System shall operate so that the probability for systematic safety cross-talk from, and to, adjacent tracks is sufficiently low.<sup>13</sup> This shall be included in the proof of safety. Safety cross-talk is defined as the acceptance of unwanted data, interpreted as valid, by an unintended On-board Transmission Equipment.

---

<sup>12</sup> Noise induced hazards are for example random disturbances leading to faults in the functions of the receiver.

<sup>13</sup> Additional protection is provided on ERTMS/ETCS system level through linking of Balise Groups (linking within Balise Groups with multiple Balises, and linking between Balise Groups).

#### **4.4.6.2.4 Localisation**

The Onboard Transmission Equipment shall be able to provide information suitable for detecting and evaluating the location reference of the Balise, and make this information available to the ERTMS/ETCS Kernel. The safety of this function is based on the passage of at least two Balises.

The localisation accuracy shall be as specified in sub-clause 4.2.10.2 on page 35, when a Balise has been passed.

#### **4.4.6.2.5 Travelling direction**

The constituents of the Transmission System shall allow evaluation of the travel direction at each Balise Group. It is not allowed to mix the order of the Balises due to longitudinal cross-talk. The safety of this function is based on the passage at least two Balises that are linked to each other.

Information about Balise sequences shall be passed on to the ERTMS/ETCS Kernel. It shall be correlated in such a way that the ERTMS/ETCS Kernel can identify that certain information is transmitted from a certain Balise.

The ERTMS/ETCS Kernel will determine the train's travel direction, by the sequence of the reported Balises.

The ERTMS/ETCS Kernel will be able to determine the train's direction of travel from received telegrams, from at least two linked consecutive Balises (e.g., two single Balises, or the Balises within a Balise Group with multiple Balises).

### 4.4.6.3 Top-level Hazards

The top-level hazards are defined in Table 4, together with their possible sources of the hazards <sup>14</sup> and the related functionality of Table 3 in sub-clause 4.4.2 on page 42. Non-considered exceptional conditions outside the specification are not explicitly mentioned herein.

No.	Hazard Description	Related function	Origin of failure
H1	A Balise is not detected	F1	Balise Air-gap On-board Transmission Equipment
H2	The On-board Transmission Equipment erroneously reports that it has detected a Balise	F1	Air-gap On-board Transmission Equipment
H3	The On-board Transmission Equipment erroneously reports detection of a Eurobalise in presence of a KER Balise	F1	Air-gap On-board Transmission Equipment
H4	Transmission of an erroneous telegram interpretable as correct	F2	Balise On-board Transmission Equipment LEU Air-gap Interface 'C' Programming
H5	Loss of the telegram, from a certain Balise, intended for full performance	F2	Balise On-board Transmission Equipment LEU Air-gap Interface 'C' Programming
H6	No transmission of Default Telegram in case of wayside failures	F2	Balise LEU Interface 'C' Programming Air-gap On-board Transmission Equipment
H7	Erroneous localisation of a Balise with reception of valid telegram <sup>15</sup>	F3	Balise Air-gap On-board Transmission Equipment
H8	The order of reported Balises, with reception of valid telegram, is erroneous	F4	Balise Air-gap On-board Transmission Equipment
H9	Erroneous reporting of a Balise in a different track, with reception of valid telegram	F2	Balise Air-gap On-board Transmission Equipment

**Table 4: List of top-level hazards**

<sup>14</sup> "Balise" includes e.g., the related installation rules for cables etc.

<sup>15</sup> Longitudinal cross-talk is an example of a wayside source for this. On-board Transmission Equipment failure in position and/or time reference of a Balise passage is an example of an on-board source.

The hazards H2, H3, H5, and H6 are not considered hazards from a system point of view, provided that the availability of the related functions is sufficient to support the apportionment to the different modes of the mission profile. This means that no quantification will be provided in sub-clauses 5.5.5.2 on page 81 and 6.4.5.2 on page 120. The hazards H2, H3, H5, and H6 are included herein for the purpose of completeness and linking between failures and consequences, and should be regarded informative as long as the availability is sufficient.

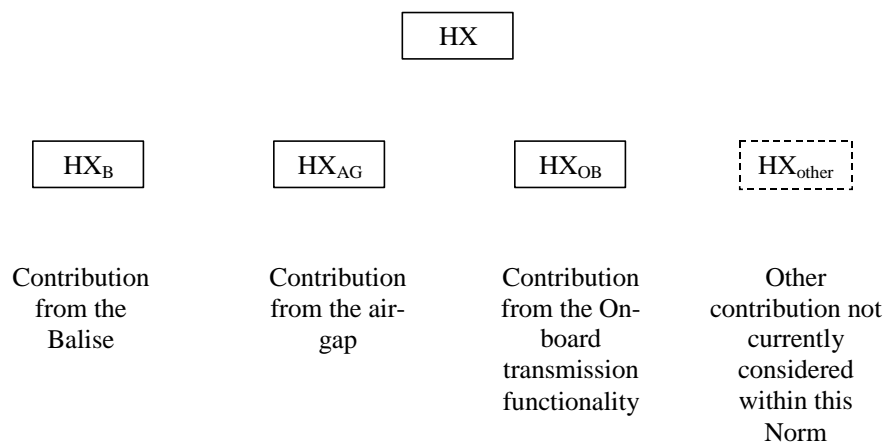
The hazards H7, H8, and H9 are caused by technical failures within the respective constituent. Potential violation of installation rules is not considered in the quantification of the constituents (sub-clauses 5.5.5.2 and 6.4.5.2), but has to be considered by other means.

#### 4.4.6.4 Principles for apportionment

Dependent on the safety objectives for the concerned items, a wrong side failure, a WSF, can originate from hardware and/or software failures, as well as all types of information errors. A WSF can lead to an accident.

Safety integrity results from the combination of quantifiable elements (generally associated to hardware, e.g., protection against random failure during the operational life of the equipment), and non-quantifiable elements (generally associated to protection against systematic failures due to for instance incomplete specifications, residual design errors, and production processes).

The top-level hazards are defined and apportioned in accordance with Table 4 of sub-clause 4.4.6.3 on page 46. In general, there are several sources for each of the hazards as illustrated in Figure 6 below.



**Figure 6: Principles for apportionment**

The hazard denomination HX refers to any of those hazards defined sub-clause 4.4.6.3. For some hazards, the general structure of Figure 6 is reduced because all sources are not applicable. The related wayside and On-board hazards (HX<sub>B</sub> and HX<sub>OB</sub>) are further detailed and quantified in sub-clauses 5.5.5 on page 78 and 6.4.5 on page 116 respectively. The air-gap contribution (HX<sub>AG</sub>) is dealt with in sub-clause 4.4.6.5 on page 48. The contribution HX<sub>other</sub> refers to sources regarded as external to this specification (e.g., LEU and programming). This is currently not within the scope of this specification, and must be considered by other means.

Specifically, regarding H4 it includes the concept of a non-trusted channel in accordance with EN 50159. The border of the non-trusted channel is company specific, and the following concepts apply:

- A. Each supplier has to define the borders between the non-trusted channel and the trusted part of the channel based on the definitions of all possible failures as defined in EN 50159.
- B. Provided that the On-board part is equal to or better than the Basic Receiver, and performs all the consistency checks on the received data that are required by the SRS (see UNISIG SUBSET-026), then it can be assumed that the coding requirements, and the defined Basic Receiver (see sub-clause 4.3.4 on page 41), protects against all possible failures within the non-trusted channel (as defined by EN 50159).
- C. The non-trusted part of the channel will need a demonstration that a minimum Tolerable Hazard Rate is fulfilled (see UNISIG SUBSET-091, ETCS\_TR03/ETCS\_OB06).

For a formal approval of the non-trusted channel, a safety demonstration is required to the level of  $10^{-11}$  failures/hour considering the mission profile defined in higher-level system documentation (see UNISIG SUBSET-091).

The quantification of sub-clauses 5.5.5 on page 78 and 6.4.5 on page 116 might originate from a hardware failure and from transient failures (e.g., due to traction noise), and is thus dependent on MTTR (including the detection time) and the actual failure frequency. The combination of all mentioned aspects should be considered.

#### 4.4.6.5 Air-gap contribution

The denomination  $HX_{AG}$  in the following refers to the explicit contribution to a hazard HX (see Table 4 on page 46) from the air-gap (e.g., due to disturbance). See the principles of Figure 6 on page 47.

$H1_{AG}$  means that the Balise is not detectable due to e.g., noise in the air-gap. This is not a contribution relevant to explicitly express. However, for the Balise it is a requirement that the environment is considered in the corresponding calculation of the Balise contribution ( $H1_B$ ). In the same way, it is required that the On-board Transmission Equipment is designed to be robust against air-gap disturbance. Consequently, also  $H1_{OB}$  shall absorb relevant contribution from air-gap disturbance.

$H2_{AG}$  means that air-gap disturbance leads to an erroneous Balise Detect (in the absence of a Balise). This is not a contribution relevant to explicitly express. However, it is required that the On-board Transmission Equipment is designed to be robust against air-gap disturbance. Consequently,  $H2_{OB}$  shall absorb relevant contribution from air-gap disturbance (which is not explicitly quantified for reasons mentioned in sub-clause 4.4.6.3 on page 46).

$H3_{AG}$  means that air-gap disturbance leads to activation of a KER Balise. The probability for this is judged incredible. Furthermore, H3 is not explicitly quantified for reasons mentioned in sub-clause 4.4.6.3 on page 46.

$H4_{AG}$  means that air-gap disturbance changes one telegram to another correct telegram (from the coding requirement standpoint). This is considered included in the not-trusted channel (see sub-clause 4.4.6.4 on page 47).

$H5_{AG}$  means that air-gap disturbance corrupts a telegram. This is not a contribution relevant to explicitly express. However, it is required that the On-board Transmission Equipment is designed to be robust against air-gap disturbance. Consequently,  $H5_{OB}$  shall absorb relevant contribution from air-gap disturbance (which is not explicitly quantified for reasons mentioned in sub-clause 4.4.6.3 on page 46).

$H6_{AG}$  means that air-gap disturbance corrupts the Default Telegram. This is not a contribution relevant to explicitly express. However, it is required that the On-board Transmission Equipment is designed to be robust against air-gap disturbance. Consequently,  $H6_{OB}$  shall absorb relevant contribution from air-gap disturbance (which is not explicitly quantified for reasons mentioned in sub-clause 4.4.6.3 on page 46).



H7<sub>AG</sub> means that disturbance in the air-gap might be transported in the infrastructure (e.g., via cables), and cause detectable Balise transmission at another position. The probability for this is negligible considering that the installation rules for the Balise shall be able to cope with the defined cross-talk conditions (which put heavier demands on the rules).

H8<sub>AG</sub> means that disturbance in the air-gap might be transported in the infrastructure (e.g., via cables), and cause detectable Balise transmission at another position. The probability for this is negligible considering that the installation rules for the Balise shall be able to cope with the defined cross-talk conditions (which put heavier demands on the rules).

H9<sub>AG</sub> means that disturbance in the air-gap might be transported in the infrastructure (e.g., via cables), and cause detectable Balise transmission at another position. The probability for this is negligible considering that the installation rules for the Balise shall be able to cope with the defined cross-talk conditions (which put heavier demands on the rules).

#### 4.4.6.6 Independence of hazard causes

For some of the hazards, dependencies also have to be considered. The aspect on dependency between air-gap introduced phenomena and the hazards of sub-clauses 5.5.5.2 on page 81 and 6.4.5.2 on page 120 shall be considered. The combined effects, e.g., hardware failures shall be analysed in the presence of noise. This contribution comes in the respective Balise and On-board Transmission Equipment. For failures in the Balise contribution, this shall be calculated for any ratio of random bit error rate. For failures in the On-board Transmission Equipment, the actual worst case situation shall be considered if known, otherwise any ratio of random bit error rate applies. See sub-clause 4.4.6.5 on page 48.

#### 4.4.6.7 Conditions

The presumptions presented in sub-clauses 5.5.5.4 on page 82 and 6.4.5.4 on page 121 apply. In particular, please observe that:

- The Basic Receiver defined in sub-clause 4.3.4 on page 41 is assumed to be implemented. In case of other receiver principles, the entire analysis included herein needs to be re-considered.
- The consistency check of the received data, required by the SRS (see UNISIG SUBSET-026), is applied on higher system level.

## 4.5 Reference Axes and Origins of Co-ordinates

Directions for the Balise and the Antenna Unit respectively shall be defined according to three reference axes related to the rails:

- A reference axis in parallel with the rails (the X-axis).
- A reference axis at right angles across the rails, and which is level with the top of rails (the Y-axis).
- A reference axis directed upwards, at right angles to the rail plane (the Z-axis).

The Balise shall carry reference marks on each of the six sides. The reference marks shall indicate the positions of the three axes, related to the electrical centre of the Balise (see also sub-clause 5.2.2.4 on page 58).<sup>16</sup>

The Antenna Unit shall carry reference marks on each of the six sides. The X, Y, and Z reference marks of the Antenna Unit indicate the positions of the X, Y, and Z axes respectively. The manufacturer of the Antenna Unit shall specify the installation measurements related to these reference marks.

In this specification the lower edge of the Antenna Unit is used as height reference mark. The offset from the lower edge to the X and Y reference marks shall be considered and indicated by the manufacturer of the Antenna Unit.

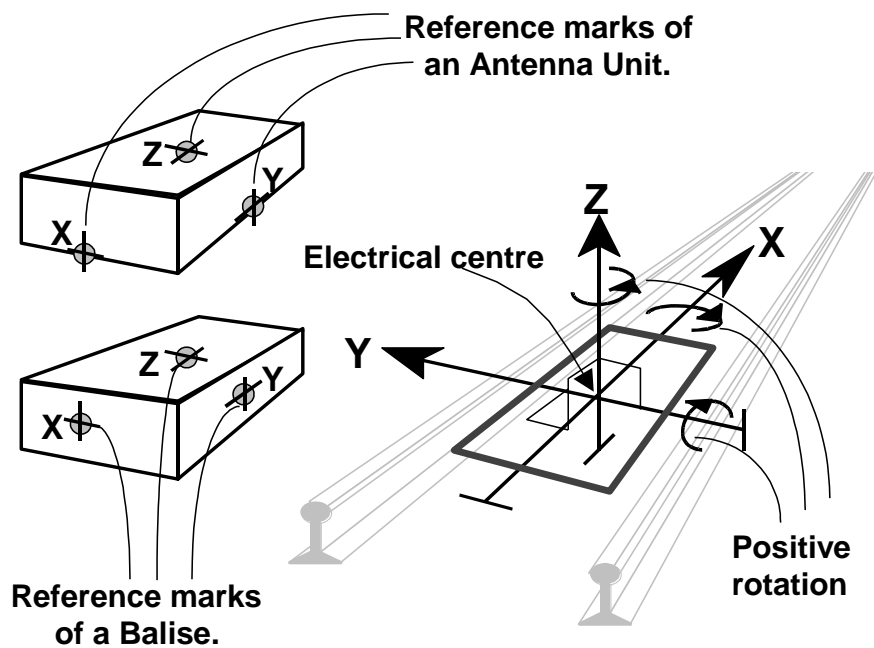


Figure 7: Reference Axes

In general the origin of co-ordinates is in the plane of the top of rails, and in the middle of the track (as indicated in the right-hand part of Figure 6 above). However, when explicitly referring to the Balise, the origin of co-ordinates is at the centre of its reference marks (and the directions of the axes are adjusted in order to coincide with potential tilt, pitch, and yaw angles of the Balise). In a similar way, when explicitly referring to the Antenna Unit, the origin of co-ordinates is at the centre of its reference marks (and the directions of the axes are adjusted in order to coincide with potential tilt, pitch, and yaw angles of the Antenna Unit).

<sup>16</sup> The electrical centre is not necessarily coinciding with the geometrical centre of the Balise.

To describe the angular deviations from the normal directions, three rotations are defined:

- **Tilt**, an angular deviation where the axis of rotation coincides with the X-axis.
- **Pitch**, an angular deviation where the axis of rotation coincides with the Y-axis.
- **Yaw**, an angular deviation where the axis of rotation coincides with the Z-axis.

To be able to exactly describe the angular deviation of an object related to these axes, the rotation operations shall be carried out in a specific sequence (starting from no angular deviation): yaw, pitch, and tilt.

The opposite order of rotation operations shall be used to align an object with the reference axes: tilt, pitch, and yaw.

## **4.6 Electrical Requirements**

### **4.6.1 On-board Equipment**

The On-board Transmission Equipment should be powered from an On-board battery power supply.

The power supply should comply with clause 3 of EN 50155.

### **4.6.2 Wayside Equipment**

For the controlled and the fixed Balise, transmission of Up-link data to interface 'A' shall occur without power from ground based equipment. The needed power for the transmission of data to Interface 'A' shall be made by Tele-powering.

A controlled Balise should, in addition to the Tele-powering, be supplied with biasing power from an LEU via Interface 'C'<sup>17</sup>. The biasing power shall not leak into the Balise transmitter part, in order not to lower the overall cross-talk immunity.

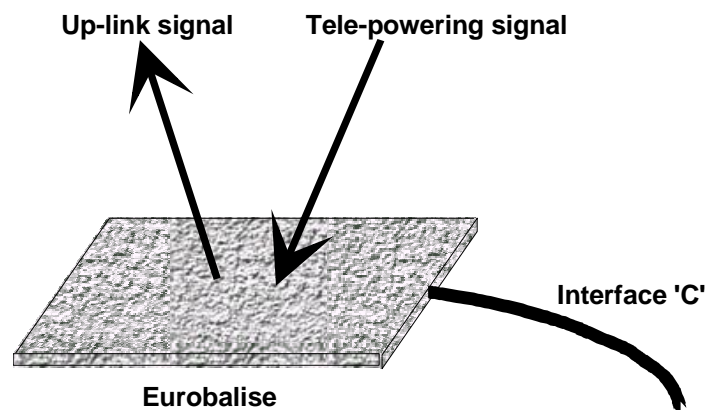
---

<sup>17</sup> The reason for this is the need to have the Balise input synchronised with the LEU output before a train passes, in situations where the time for transmission is limited to a minimum.

## 5 Up-link Balise

### 5.1 Architectural Layouts

A Eurobalise is a device that is interrogated and Tele-powered by means of an inductively coupled Tele-powering signal, see sub-clause 6.2.1 on page 108. The response of the Eurobalise is also an inductively coupled Up-link signal, see sub-clause 5.2.2 on page 53. Source and sink of the Tele-powering signal and the Up-link signal respectively is the vehicle mounted Antenna Unit.



**Figure 8: Eurobalise and its main interfaces**

The origin of the data carried by the Up-link signal shall be a non-volatile memory in the Eurobalise, or a serial data-link referenced as Interface 'C', see sub-clause 5.3 on page 68. The data in the non-volatile memory shall be programmable by means of the programming principles of sub-clause 5.4 on page 74.

### 5.2 Balise air-gap Interface

#### 5.2.1 Balise Tele-powering

##### 5.2.1.1 Specification of the Tele-powering signal

An Up-link Balise shall be able to operate compliantly with sub-clause 5.2.2 on page 53 when being powered by a CW Tele-powering signal as specified in sub-clause 6.2.1.2.1 on page 109.

An Up-link Balise shall be able to operate compliantly with sub-clause 5.2.2 on page 53 when being powered by a toggling Tele-powering signal as specified in sub-clause B1.1 of Annex B on page 136.

##### 5.2.1.2 Compatibility requirements on the Balise Tele-powering

An Up-link Balise shall be compatible with a Tele-powering signal that is AM modulated by a non-toggling 50 kHz synchronisation signal defined in sub-clause B1.2 of Annex B on page 136.

The compatibility requirements shall be as defined in sub-clause 5.2.2.9 on page 67.

## 5.2.2 Up-link Data Transmission

### 5.2.2.1 Transmission medium

The Balise shall generate a magnetic field that shall be picked up by the On-board Antenna Unit. This magnetic field shall be produced in a transmit loop of the Balise, and shall induce a voltage in a horizontal reception loop of the Antenna Unit.

### 5.2.2.2 Up-link Electrical Data

#### 5.2.2.2.1 General

The following requirements apply after a start-up time for the Balise of  $T_{BAL}$  [ $\mu$ s], as defined in sub-clause 5.2.2.9 on page 67.

#### 5.2.2.2.2 Centre Frequency and Frequency Deviation

The magnetic field shall produce two frequencies that shall be used for frequency shift keying (FSK) of the Up-link data. The two frequencies shall nominally be 3.951 MHz for a logical 0 ( $f_L$ )<sup>18</sup> and nominally be 4.516 MHz for a logical 1 ( $f_H$ )<sup>19</sup>. In a shift between the two frequencies the carrier shall have a continuous phase (i.e., continuous phase frequency shift keying modulation shall apply).

- The centre frequency shall be  $(f_H + f_L)/2 = 4.234 \text{ MHz} \pm 175 \text{ kHz}$ .
- The frequency deviation shall be  $(f_H - f_L)/2 = 282.24 \text{ kHz} \pm 7 \%$ .

Centre frequency and frequency deviation shall be measured by means of analysing the signal within a sliding window of fixed length. The signal shall be observed within a band width greater than twice the 10 dB signal band width (i.e., more than 2 MHz). The total measuring time shall be long compared to the sliding window and in the range of one telegram. The window itself shall be fairly short compared to the length of a data bit, but long enough to respect the needed band width.

The upper and lower frequencies detected within a 16 bit long sliding window shall be averaged separately for each individual bit, dependent on the decoded bit (i.e., the frequency for decoded “1” bits and “0” bits shall be averaged separately and on a bit by bit basis). This evaluation should be based on demodulated frequency values sufficiently far from the bit transition regions. A time period of not more than the time equivalent to one period of the carrier (236 ns) could possibly be ignored around the bit transition if proven practical for test purposes.

Centre frequency shall be calculated as  $(f_{Lmax} + f_{Hmax})/2$  and  $(f_{Lmin} + f_{Hmin})/2$  within the fixed sliding 16 bit window. Both calculations shall result in compliance with the requirement defined above.

Frequency deviation shall be calculated as  $(f_{Hmax} - f_{Lmin})/2$  and  $(f_{Hmin} - f_{Lmax})/2$  within the fixed sliding 16 bit window. Both calculations shall result in compliance with the requirement defined above.

---

<sup>18</sup> One ‘0’-bit corresponds to approximately 7 periods of 3.951 MHz.

<sup>19</sup> One ‘1’-bit corresponds to approximately 8 periods of 4.516 MHz.

### 5.2.2.2.3 Mean Data Rate

The mean data rate is defined as 1500 divided by the length of 1500 consecutive data bits. For any consecutive 1500 bits, the mean data rate shall be 564.48 kbit/s, with an overall tolerance of  $\pm 2.5\%$ , i.e.:

$$\frac{1500}{T(\text{bit}_{i+1500}) - T(\text{bit}_i)} = 564.48 \cdot 10^3 \pm 2.5\% \quad \forall i$$

### 5.2.2.2.4 Data Rate Variation

After the defined start-up period ( $T_{\text{BAL}}$  according to sub-clause 5.2.2.9 on page 67), the data rate variation (around the mean data rate, as defined above) and the jitter of the data from the Balise shall fulfil either the MTIE requirement 1 (relative to the theoretical data rate) or the MTIE requirement 2 (relative to the transmitted mean data rate) below.<sup>20</sup>

The measurement method shall be based on phase demodulation of the Up-link signal performed in a sufficient amount of points during a one bit window, evaluation of the best linear fit of these phase samples (linear regression) during the bit window, identification of the exact instants of bit transition, evaluation of the overall time interval error considering the combination of data rate and carrier phase errors, and a verification of the MTIE 1 or MTIE 2 requirements using the curves below (Figure 9 and Figure 10). The bit transitions are defined as where the two best fit lines of successive “one” and “zero” (or “zero” and “one”) bits meet. In the event of many successive “ones” or “zeroes” (maximum 8 according to sub-clause A1.1.2 of Annex A on page 132), the distance between discernible bit transitions is split into a suitable amount of equally long bits, and consequently the overall time interval error is assigned (split) in equal parts to the same number of bits.

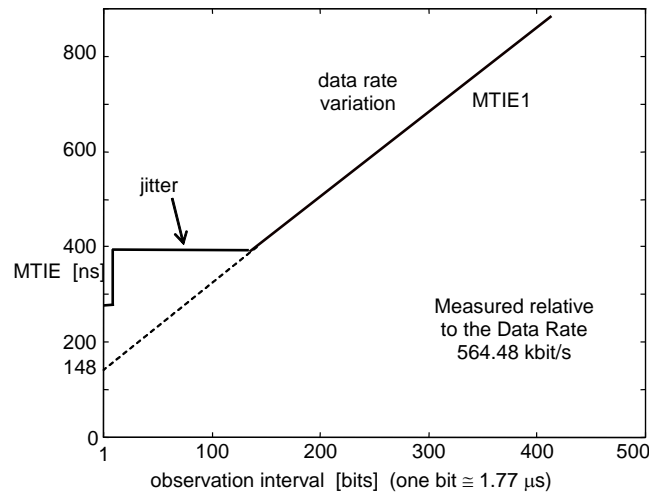
#### MTIE requirement 1:

$272 \cdot 10^{-9}$ s	for	$1 \leq \tau \leq 16$ bit
$396 \cdot 10^{-9}$ s	for	$16 \text{ bit} < \tau \leq 140$ bit
$\tau \cdot 10^{-6}/564.48 + 148 \cdot 10^{-9}$ s	for	$140 \text{ bit} < \tau \leq 1000$ bit

where  $\tau$  is the observation interval in bits, and the MTIE is measured relative to the data rate 564.48 kbit/s.

---

<sup>20</sup> MTIE (n) =  $\max_{1 \leq k \leq N-n} (\max_{k \leq i \leq k+n} d_i - \min_{k \leq i \leq k+n} d_i)$ ; n = 1, 2, 3, 4, ..., N-1 is the window length used for the analysis, k is the starting position of the window, N is the total number of examined symbols,  $d_i$  is the error (with the sign) of the ending instant of the bit i within the examined window with respect to the used reference clock.

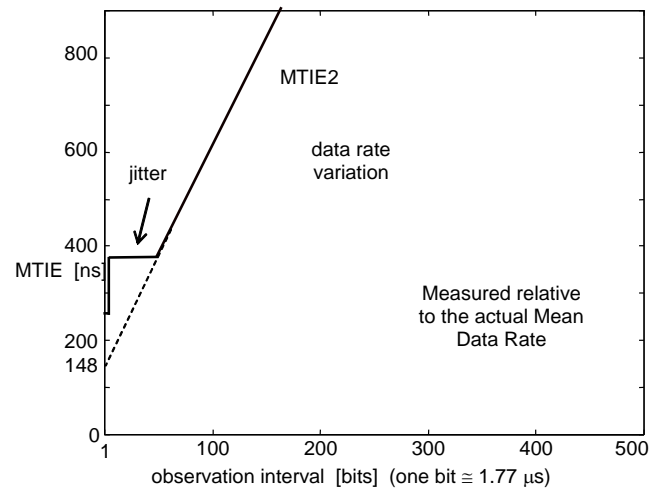


**Figure 9: MTIE requirement 1**

**MTIE requirement 2:**

- $236 \cdot 10^{-9} \text{ s}$  for  $1 \text{ bit} \leq \tau \leq 5 \text{ bit}$
- $370 \cdot 10^{-9} \text{ s}$  for  $5 \text{ bit} < \tau \leq 50 \text{ bit}$
- $2.5 \cdot \tau \cdot 10^{-6} / 564.48 + 148 \cdot 10^{-9} \text{ s}$  for  $50 \text{ bit} < \tau \leq 1000 \text{ bit}$

where  $\tau$  is the observation interval in bits, and the MTIE is measured relative to the mean data rate.



**Figure 10: MTIE requirement 2**

### 5.2.2.2.5 Amplitude Jitter

The allowed amplitude jitter shall be  $+1.5/-2.0$  dB per any period of  $1.77 \mu\text{s}$  (independent of a bit transition) on the average amplitude value for that period of time.

Amplitude jitter shall be measured both during a start-up ramp simulating the activation of a Balise upon train passage, and during steady state conditions. The Up-link signal amplitude received by a field probe shall be measured, and data shall be analysed within two sliding windows of fixed length. One window shall be long compared to the length of a data bit, and the other window shall have the length of a single data bit (according to the actual bit duration, approximately  $1.77 \mu\text{s}$ ).

The amplitude jitter is defined as the ratio between the average amplitude of the Up-link signal amplitude, evaluated over a time window ( $W_i$ ) of  $1.77 \mu\text{s}$  at the centre of another much longer time window ( $W_m$ ) of defined length, and the average amplitude of the signal amplitude evaluated over this last time window  $W_m$ . The time window  $W_m$  should be of different lengths, in order to cope with different Tele-powering conditions for the Balise under test. A duration of  $50 \mu\text{s} - 100 \mu\text{s}$  should be chosen when simulating dynamic Tele-powering conditions, whilst a duration of  $400 \mu\text{s} - 800 \mu\text{s}$  should be chosen when measuring the amplitude jitter with constant Tele-powering flux.

In both conditions, a number of consecutive measurement steps shall be carried out in order to continuously scan an entire signal record of defined duration ( $T_s$ ). This is achieved by shifting the time window  $W_m$  (and consequently the centred time window  $W_i$ ) from the start of the signal record, after each measurement, by one step of  $1.77 \mu\text{s}$  up to the end.

When the signal is acquired and elaborated, the bandwidth of the measuring equipment shall be wider than the signal bandwidth. A bandwidth of 4 MHz is a reasonable compromise. It should be narrow enough not to measure signals outside the defined signal bandwidth, but wide enough not to create excessive errors due to for example time delays or transients.

Figure 11 exemplifies the above defined process.

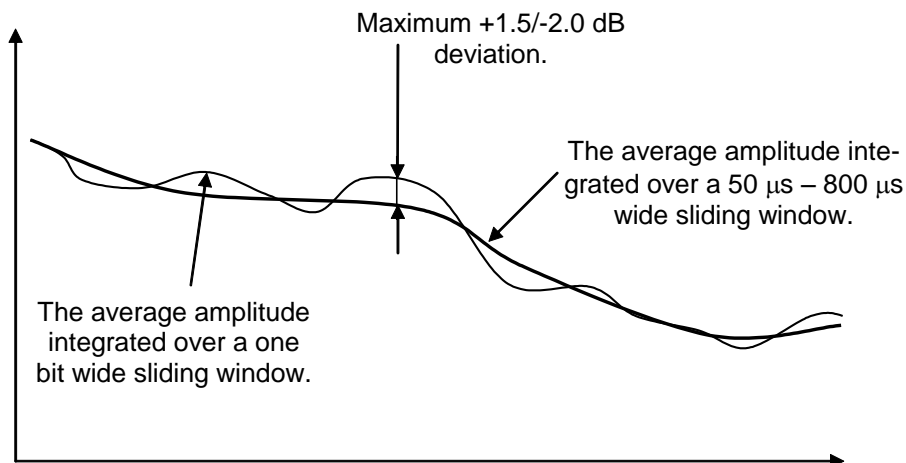


Figure 11: Amplitude jitter



### 5.2.2.2.6 Signal Band width

The 10 dB signal bandwidth shall be less than 1000 kHz when random user data is transmitted. This requirement shall be verified using the following procedure. In a first step, the signal power is measured in a 1 MHz wide band centred around the already determined centre frequency. This is performed through evaluation of the RMS averaged spectrum of the signal, using a Resolution Bandwidth of approximately 4.8 kHz, a Span of 4 MHz (corresponding to a signal record length of 800  $\mu$ s), and an averaging factor of 10. The signal power is then obtained by integration of this spectrum within the above defined 1 MHz band. Thereafter, the same process is repeated, but with the 1 MHz window centred respectively 1 MHz above, and 1 MHz below, the already determined centre frequency. The sum of the signal power within the latter two 1 MHz windows shall be at least 10 dB below the signal power of the 1 MHz window that was centred around the centre frequency (the first measurement).

### 5.2.2.3 Antenna Unit and Balise interaction

The operational requirements on the Eurobalise Transmission System depend on the design of the Antenna Unit, the design of the Balise, and the requirements in this document.

Two sizes of the Balise shall be considered, Standard Size and Reduced Size Balises. A Reduced Size Balise shall also be allowed for transversal installation (i.e., the longer side in a right angle to the track).

To make interoperability possible, the position relative to the track and the size of the active reference area of the Balises shall be the same for all manufacturers, in accordance with this specification (see also sub-clause 5.2.2.4 on page 58). This cannot be changed in the future without considering interoperability with already delivered products.

The influence of metal masses like metal sleepers and metal structures underneath the Balise may influence the flux from an Antenna Unit into the reference area of the Balise, and influence the field from the reference area to an Antenna Unit. Therefore, and due to the requirement for interoperability, the position of the reference area relative to metal masses shall also be the same for all manufacturers.

The following length of telegram shall apply for the size of the Balise versus the Maximum Permitted Speed at the location where the Balise is installed:

Balise type	Maximum Permitted Speed	
	$v \leq 300$ km/h	$300 < v \leq 500$ km/h
Standard Size	Long (1023 bits) and Short (341 bits)	Long (1023 bits) and Short (341 bits)
Reduced Size	Long (1023 bits) and Short (341 bits)	Short (341 bits)

**Table 5: Telegram length versus Balise type and Maximum Permitted Speed**

#### 5.2.2.4 Balise Reference Areas

For interoperability reasons, within the Eurobalise Transmission System, the size of the reference area, that the performance of the Balise is related to, shall be standardised.

The operational requirements and the output field strength of the antenna loop(s) of the Balise are final, i.e., they can not be changed in future implementations and designs of the system.

The Standard Size and the Reduced Size Balises have the following reference areas for defining the field strength from an Antenna Unit as well as the output field strength from a Balise:

- The Standard Size Balise shall have the active reference area  $358 \text{ mm} \times 488 \text{ mm}$ .
- The Reduced Size Balise shall have the active reference area  $200 \text{ mm} \times 390 \text{ mm}$ .

The reference area shall be centred around the Z axis and be in level with the X and Y axes of a Balise.

The output signal from the Antenna Unit shall be defined as the total flux  $\Phi_d$  through the reference area in a position related to the reference marks of the Balise. The field from the Antenna Unit is not homogeneous in the vicinity of the Antenna Unit.

The output field strength from a Balise shall be defined as the current  $I_U$  that encircles the reference area in a position related to the reference marks of the Balise.

Reference Loops of two different sizes should be used for measuring the flux from an Antenna Unit and for measuring the field strength from a Balise. The Reference Loops shall be conform with the definitions of the reference areas.

The input flux to a Balise shall be conform with the flux measured through the reference area. The output field from a Balise shall be conform with the field from a current encircling the reference area.

For reference axes see definition in sub-clause 4.5 on page 50.

### 5.2.2.5 Field Distribution

The vertical component of the field strength from the Up-link Balise shall be conform with a reference field. The reference field is the vertical component in free space from a constant current that encircles the reference area, see sub-clause 5.2.2.4 on page 58. When the field strength from the reference area is lower than the levels R0-C and R0-D respectively, as defined below, the reference field shall be limited to the levels R0-C (only in the notch region close to the Main Lobe Zone) and R0-D respectively. The difference, expressed in dB, between the output signal level generated by the Balise and the level of the reference field constitutes the conformity deviation for Up-link.

For the conformity of the field form three zones are defined: the Main Lobe Zone, the side lobe zone, and the Balise cross-talk zone.

The input signal to the Balise is the flux through the reference area defined for the Balise, originating from the Antenna Unit. The conformity of the input signal to the Balise with the field received in the reference area shall be within the same tolerances as for the Up-link.<sup>21</sup> Conformity in Tele-powering applies only in the Main Lobe Zone and in the Side lobe zone.

The resolution of the evaluation of conformity is dependent on the size of the area (a smaller area gives a better resolution). However, it is not practically possible to perform the evaluation with an infinitely small area. The evaluation of the conformity shall be performed with a square-shaped area of maximum 200 mm by 200 mm. The maximum area for conformity evaluation of the Up-link signal may be larger within the Balise cross-talk zone.<sup>22</sup>

The Main Lobe Zone is defined as the volume within the 16 corners of Figure 12.

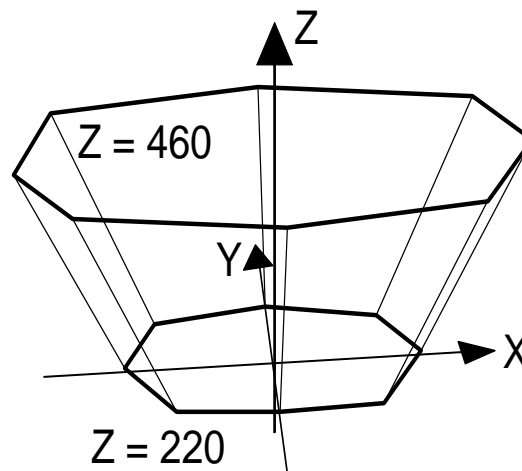


Figure 12: The Main Lobe Zone

<sup>21</sup> The conformity of the Tele-powering is reciprocal to the Up-link. This means that the vertical Up-link field from the Balise in any point of interest may be interchanged with the vertical Tele-powering magnetic dipole moment from a small loop, in the same point, in the free space above the Balise. The vertical dipole moment is the current multiplied with the horizontally encircled area. Thus, the Up-link reference field corresponds to the Tele-powering reference magnetic dipole moments for each point of interest above the Balise. The difference between the magnetic dipole moment, which activates the Balise to a given level, and the reference magnetic dipole moment constitutes the conformity deviation for Tele-powering.

<sup>22</sup> Due to practical reasons, and the uniformity of the field.

The volume of the Main Lobe Zone is shown in the tables of Figure 13, related to the centre of the Balise (as per the reference marks of the Balise and the direction co-ordinates defined in sub-clause 4.5 on page 50):

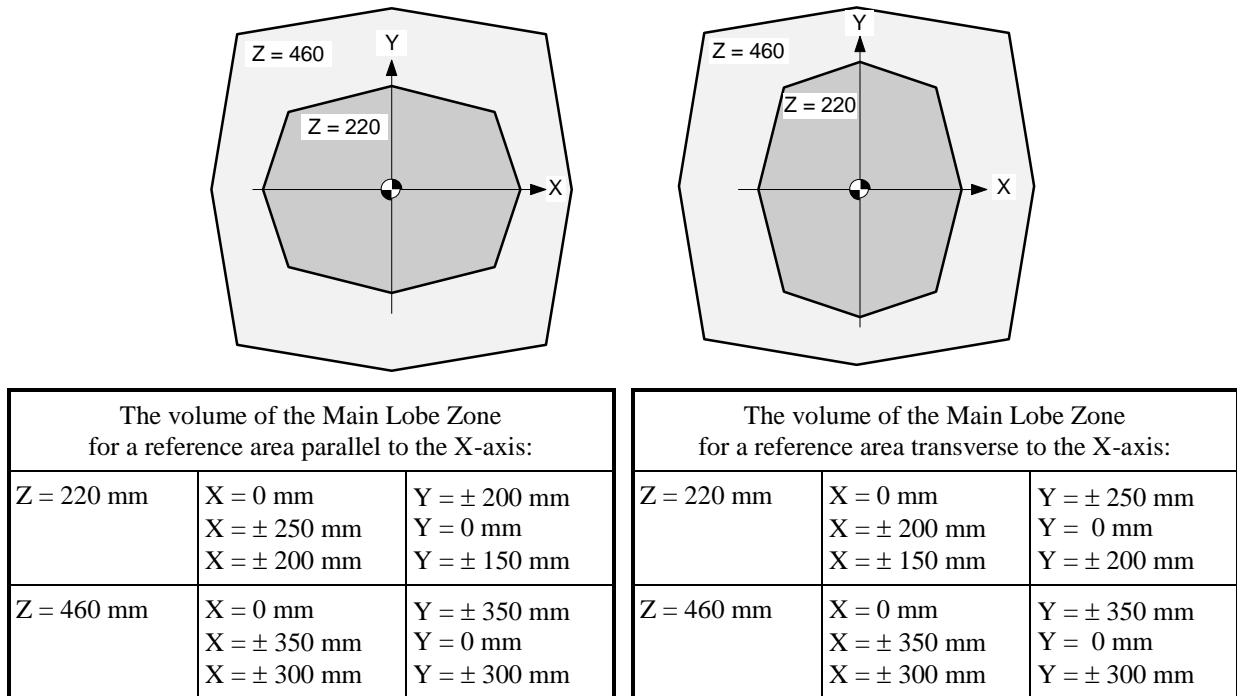


Figure 13: The volume of the Main Lobe Zone

Within the Main Lobe Zone the conformity requirement is that the difference between a field generated by a Balise and the reference field shall be within ±1.5 dB, see Figure 14 and Figure 15.

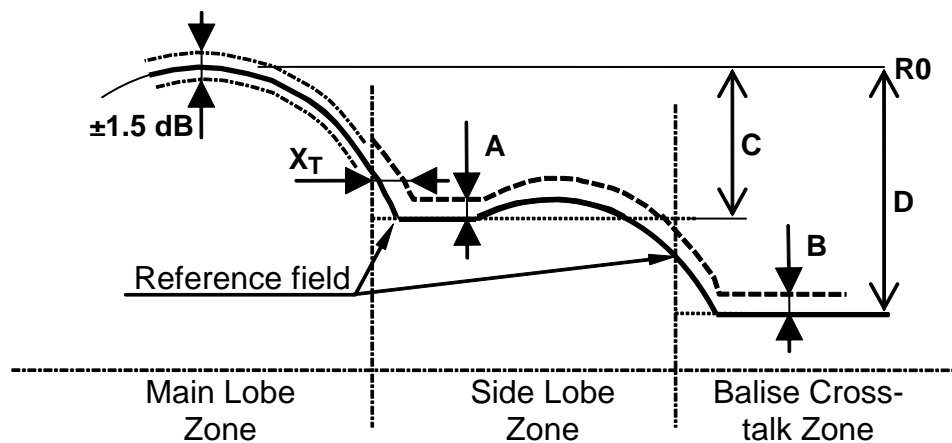
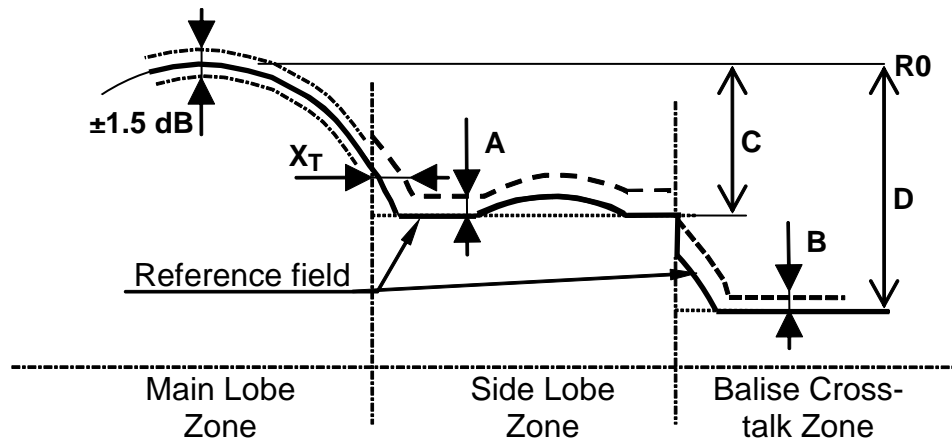


Figure 14: Reference field and limits, Up-link



**Figure 15: Reference field and limits, Tele-powering**

The side lobe zone is the volume around the Balise defined by the following co-ordinates, excluding the Main Lobe Zone:

- $-1300 \text{ mm} < X < +1300 \text{ mm}$
- $-1400 \text{ mm} < Y < +1400 \text{ mm}$
- $+220 \text{ mm} < Z < +460 \text{ mm}$

In the part of the side lobe zone closest to the Main Lobe Zone (the notch region), the reference field is limited to be no more than C dB lower than the highest field strength in the Main Lobe Zone at the level  $Z = 220 \text{ mm}$  ( $R_0$ ). This (in the notch region) applies to both Up-link and Tele-powering cases. The same also applies in the extreme regions near the cross-talk protected zone, but for the Tele-powering case only.

In the side lobe zone the reference field is also limited to be no lower than the values given by the reference field translated  $+x_T \text{ cm}$  or  $-x_T \text{ cm}$  along the X axis, and translated  $+y_T \text{ cm}$  or  $-y_T \text{ cm}$  along the Y axis.

The conformity requirement for the side lobe zone is that the difference between a field generated by a Balise and the reference field shall be between  $+A \text{ dB}$  and  $-\infty \text{ dB}$ , see Figure 14 and Figure 15.

Tolerances and limits for the side lobe zone:

- $A = 5 \text{ dB}$
- $C = 35 \text{ dB}$
- $x_T = 5 \text{ cm}$
- $y_T = 5 \text{ cm}$

In the Balise cross-talk zone the reference field is limited to be no more than D dB lower than the highest field strength in the Main Lobe Zone at level Z = 220 mm (R0).

The conformity requirement for the Balise cross-talk zone is that the difference between a field generated by a Balise and the reference field shall be between +B dB and  $-\infty$  dB, see Figure 14 and Figure 15.

Tolerances and limits for the Balise cross-talk zone:

- B = 5 dB
- D = 60 dB

The field from the Balise, and the flux through the Balise, may deviate from the form of the field in free space due to debris and to the proximity to conductive material. The influence of such deviations of the field form shall be considered in the Antenna Unit design.

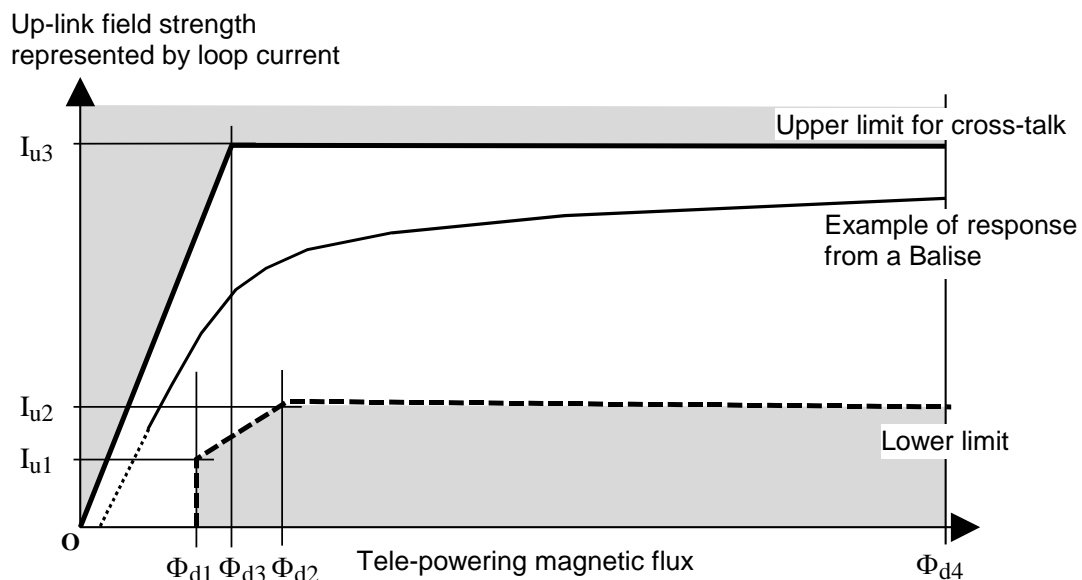
Debris and the proximity to conductive material may influence the efficiency of the Balise itself. Such influence shall be within the specified limits for the performance of the Balise.

The levels of debris, denominated Class A and Class B layers, are defined in sub-clause 5.7.9 on page 92.

### 5.2.2.6 Transmission in the Main Lobe Zone

The input-to-output characteristics of a Balise shall be according to Figure 16 below. The upper limit is mainly related to intrinsic cross-talk protection, and the lower limit is mainly related to detection of Up-link Balises. The influence from debris (see sub-clause 5.7.9 on page 92), metallic structures on ground (see sub-clause 5.7.10 on page 94), approved mounting details (see sub-clause 5.7.10.3 on page 96), and cables (see sub-clauses 5.7.10.7 on page 103 and 5.3.4 on page 74) shall be included. However, please observe the correction of the flux levels defined in Table 15 of sub-clause 5.7.9 on page 93 during the influence of some debris conditions. The Balise response shall be inside the area limited by the shaded areas in Figure 16, and considering the measurement errors. Furthermore, the Balise response shall be inside this area for all the geometrical positions of the Main Lobe Zone considering the actual Balise Conformity performance. The latter requirement means that the upper and lower restrictions must be further limited by the difference between the actual Balise Conformity deviation for the test point of the I/O characteristics test, and the worst case Balise Conformity deviations (maximum and minimum) for all other geometrical test points within the Main Lobe Zone.

The field strength from the Antenna Unit shall be defined as stated in sub-clause 6.2.1.5 on page 110.



**Figure 16: Input-to-output characteristics for a Balise**

Characteristics for a Standard Size Balise:

$I_{u1} = 23 \text{ mA}$	$I_{u2} = 37 \text{ mA}$	$I_{u3} = 116 \text{ mA}$	$I_{u3} = 116 \text{ mA}$	Non-permanent damage <sup>23</sup>
$\Phi_{d1} = 7.7 \text{ nVs}$	$\Phi_{d2} = 12.2 \text{ nVs}$	$\Phi_{d3} = 9.2 \text{ nVs}$	$\Phi_{d4} = 200 \text{ nVs}$	$\Phi_{d5} = 300 \text{ nVs}$

Characteristics for a Reduced Size Balise:

$I_{u1} = 37 \text{ mA}$	$I_{u2} = 59 \text{ mA}$	$I_{u3} = 186 \text{ mA}$	$I_{u3} = 186 \text{ mA}$	Non-permanent damage <sup>23</sup>
$\Phi_{d1} = 4.9 \text{ nVs}$	$\Phi_{d2} = 7.7 \text{ nVs}$	$\Phi_{d3} = 5.8 \text{ nVs}$	$\Phi_{d4} = 130 \text{ nVs}$	$\Phi_{d5} = 250 \text{ nVs}$

<sup>23</sup> Without being permanently damaged the Balise shall withstand the flux level  $\Phi_{d5}$ , including also non-toggling modulation.

When the total flux from the Antenna Unit through the defined reference area of the Balise exceeds  $\Phi_{d1}$ , the Balise shall start to operate (see sub-clause 5.2.2.9 on page 67), and the field strength from the Balise shall be higher than a field strength represented by a current of  $I_{u1}$  that flows in a conductor encircling the reference area.

When the flux from the Antenna Unit exceeds  $\Phi_{d2}$  (Figure 16, sub-clause 5.2.2.6 page 63), the field strength from the Balise shall exceed the field strength from a current  $I_{u2}$  in the encircling conductor.

The output signal from the Balise for an input signal lower than  $\Phi_{d1}$  shall be regarded to be non-specified for properties other than the maximum signal level.

The Balise shall operate in saturation mode when the flux from the Antenna Unit through the defined reference area of the Balise is high. Then, for an increasing input flux, the field strength from the Up-link Balise shall be approximately constant and may not fall more than  $-0.5$  [dB/dB].<sup>24</sup>

When the flux from the Antenna Unit exceeds  $\Phi_{d4}$  (Figure 16, sub-clause 5.2.2.6 page 63), the proper function of the Balise can not be guaranteed. Thus, the Antenna Unit shall not create a flux that exceeds  $\Phi_{d4}$ .

When the Balise receives a flux  $\Phi_d$  from the Antenna Unit, a voltage is induced in the Balise receiver loop. The Balise loads the induced voltage, which in turn generates a current  $I_{\text{reflected}}$  in the receiver loop. This current may, if the distance to the Antenna Unit is very close, influence the Antenna Unit. This interaction can be expressed as an impedance  $Z_{\text{reflected}}$  (the induced voltage  $\omega\Phi_d$  divided by the current  $I_{\text{reflected}}$ ).

The absolute value of the complex impedance  $Z_{\text{reflected}}$  of the Standard Size Balise shall be higher than  $60 \Omega$  when the Balise receives a flux reaching  $\Phi_{d4} +0/-3$  dB.

The absolute value of the complex impedance  $Z_{\text{reflected}}$  of the Reduced Size Balise shall be higher than  $40 \Omega$  when the Balise receives a flux reaching  $\Phi_{d4} +0/-3$  dB.

---

<sup>24</sup> Example: If  $\Phi_d$  rises 1 dB then the output field may not fall more than 0.5 dB. This is required in order to ensure that a correct location reference can be set by the On-board Transmission Equipment.



### 5.2.2.7 Cross-talk Conditions

Cross-talk protection is based on the following properties regarding the Balise and its accompanied installation rules:

- The fulfilment of the input-to output characteristics within the Main Lobe Zone in all specified conditions.
- The fulfilment of the conformity requirements in free air.
- The fulfilment of Up-link current induction into nearby cables, and Balise controlling interface cables, considering the company specific rules.
- The fulfilment of the company specific installation rules for cables.
- The fulfilment of requirements related to installation in the vicinity of Guard Rails.
- The fulfilment of requirements related to Loop Cable.

The worst case condition with cables is when a Balise is installed close to a cable, as shown in Figure 40 of sub-clause 5.7.10.7.1 on page 103, which also crosses another track. The current level in the cable at the position where a potential On-board Transmission Equipment may pass the same cable have to respect the limits in sub-clause 5.7.10.7 on page 103. This applies for a current that originates from a Balise that is in a cross-talk position (relative to the above On-board Transmission Equipment). The company specific installation rules for the Balises shall limit the induced electromotive force so that the Up-link current limits of sub-clause 5.7.10.7 on page 103 are fulfilled.

It is the responsibility of the Balise manufacturer to specify installation rules considering the company specific common mode properties of the Balise controlling interface in order to not exceed the effect on the On-board Transmission Equipment of the current limits specified in sub-clause 5.7.10.7 on page 103 in the relation to the Up-link induced current.

## 5.2.2.8 Protocol

### 5.2.2.8.1 Start-up of the Transmission Link

When the flux from the Antenna Unit is high enough, the Up-link Balise shall start to send the intended message. This must occur at a flux equal to or lower than  $\Phi_{d1}$ . The Balise start-up time shall be as defined in sub-clause 5.2.2.9 on page 67.

### 5.2.2.8.2 Handshaking

No handshaking shall be required.

### 5.2.2.8.3 Disconnection

The Up-link telegram shall be sent uninterrupted as long as the Up-link Balise receives enough flux from the On-board Antenna Unit.

### 5.2.2.8.4 Synchronisation

The telegrams shall be sent cyclically. To avoid the need for awaiting the start bit of one telegram the applied coding allows to find the beginning of the message content after a redundancy check has been performed.

The data protection properties of this code are described in sub-clause 4.3 on page 36.

### 5.2.2.8.5 Procedures

The Up-link transmission shall be transparent from Interface 'C' to Interface 'A'. This means that all received data shall be transmitted by the Up-link Balise, when it is activated. The data shall be transmitted in FIFO order.

When switching telegrams in the Wayside Signalling Equipment or in the Up-link Balise, a sequence of between 75 bits and 128 bits of only logical '1' or only logical '0' shall be inserted in-between the old and the new telegram. These '1' or '0' sequences shall be inserted by the LEU in general cases, and by the Balise when switching to the Default Telegram is activated.

It shall be allowed to transmit a sequence of between 75 bits and 128 bits of only logical '1' or only logical '0' from the LEU to Interface 'C'.<sup>25</sup> The insertion of the above mentioned bits shall not have any impact on the reliability.

### 5.2.2.8.6 Default Telegram

Under failure conditions<sup>26</sup>, the Balise shall transmit a Default Telegram to Interface 'A'.

If the Balise switches from sending the LEU data to sending the Default Telegram during the passage of the train, it shall continue to send the Default Telegram as long as the Balise is sufficiently energised.

Switching from LEU data to the Default Telegram shall be done according to the requirements in sub-clause 5.2.2.8.5.

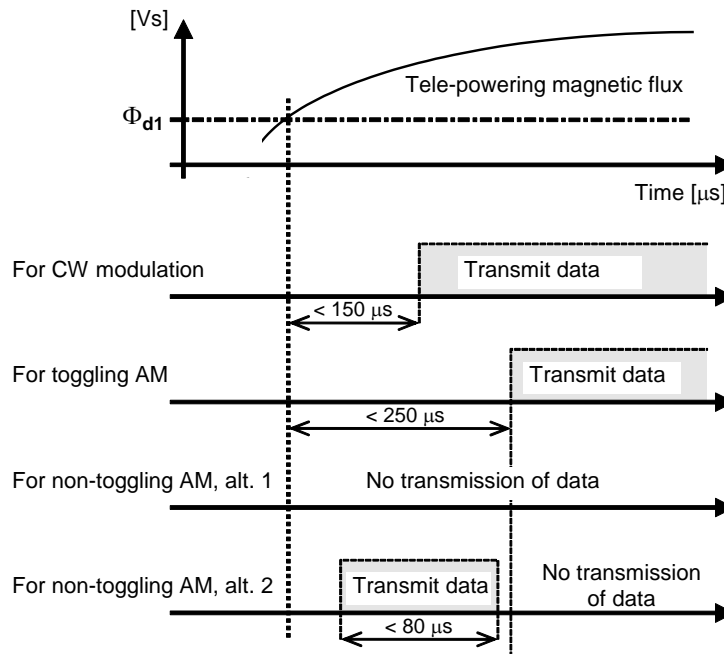
---

<sup>25</sup> The telegram transmitted before and after the sequence can be the same.

<sup>26</sup> Failure conditions can be the result of for example a cut cable, absence of signals, interference (bursts) on Interface 'C', or insufficient quality according to sub-clause 5.3.2.3.6 on page 82.

### 5.2.2.9 Interoperability and compatibility requirements on the Balise Up-link transmission

The Up-link Balise shall have started to operate when the flux from the Antenna Unit has reached  $\Phi_{d1}$ . Then it shall choose the appropriate transmission mode, based on the kind of modulation of the received Tele-powering signal, for the purpose of compatibility. A Eurobalise shall be silent when it is being activated by KVB, Ebicab or RSDD. The Tele-powering signal from these systems is a non-toggling 50 kHz modulated 27 MHz signal (see sub-clause B1.2 of Annex B on page 136).



**Figure 17: Timing diagram for Balise start-up**

When the Tele-powering signal is CW, the Up-link Balise shall within the time limit 150 μs ( $T_{BAL}$ ) start to send the data using FSK modulation to the Interface 'A1'.

When the Tele-powering signal is amplitude modulated (toggling or non-toggling modulation), a Balise shall either not respond for a period of time that does not exceed 250 μs ( $T_{BAL}$ ), or it may transmit data for less than 80 μs, until it has decided whether the AM is toggling or not. Then two alternative mode transfers shall exist:

1. For a toggling AM it shall start (alternatively proceed) sending the Up-link signal using FSK modulation.
2. For a non-toggling AM it shall remain passive (not sending any data), alternatively stop sending the Up-link signal within 80 μs from the moment the transmission started. The Balise shall send data also when a toggling decision could not be taken.

### 5.2.2.10 Coding requirements

See sub-clause 4.3 on page 36.

## 5.3 Balise Controlling Interfaces

### 5.3.1 Introduction

This sub-clause defines the interface between the Balise constituent and the Lineside Electronic Unit (LEU).

The Balise controlling interface cable is regarded part of the Balise, and is the responsibility of the Balise manufacturer. Therefore the interface is mainly specified at the LEU output.

Connectors can be used on both the Balise and on the cable. The use of these connectors is not mandatory, and other means of connections are allowed.

For Up-link transmission, the LEU receives messages from wayside signalling or interlocking. These messages are converted into Up-link Eurobalise Telegrams, and are passed on through the Interface 'C' to the Balise, which transmits the Eurobalise Telegrams to the On-board equipment of the passing trains. This specification defines a 'Preferred Solution', that is valid for cable lengths of up to 500 m. Longer cable lengths will require other, more stringent requirements, which are not standardised.

This sub-clause defines four different interfaces:

- Up-link data input, Interface 'C1'
- Output Blocking signal , Interface 'C4' (optional)
- Balise programming interface, Interface 'C5'
- Auxiliary energy input, Interface 'C6'

Interface 'C1', Interface 'C6', and Interface 'C4' shall share the same transmission medium (the same cable).

Interfaces 'C1' and 'C6' are defined in the following sub-clauses (see sub clauses 5.3.2 and 5.3.3), and the specifications apply to the LEU output unless otherwise explicitly stated.

The optional output blocking signal (Interface 'C4') is defined in clause D4 of Annex D on page 143, and the specifications apply to the Balise output unless otherwise explicitly stated.

The Balise programming interface (Interface 'C5') is not within the scope of this specification.

## 5.3.2 Up-link Data Input (Interface 'C1')

### 5.3.2.1 General

Interface 'C1' shall be used for transmitting Eurobalise Telegrams from the LEU to the Balise.

### 5.3.2.2 Functional Requirements

Accidental short circuit for infinite time to the signals shall not permanently damage any connected equipment.

This interface shall be considered transparent, which implies that the transmitted messages do not need to be defined within this specification.

### 5.3.2.3 Physical Transmission

#### 5.3.2.3.1 Transmission Medium

The signal shall be polarity independent. This means that interchanging the two input leads shall not affect the received bit stream.

The transmission shall be base band signals on electrical conductors.

#### 5.3.2.3.2 Electrical Data

##### 5.3.2.3.2.1 Signal Level

The signal level  $V_2$  as defined according to Figure 19 on page 71 shall be limited according to Table 6 into a resistive 120  $\Omega$  load.

Signal level, $V_2$	Requirement at the LEU output
Minimum value	$> 14 V_{pp}$
Maximum value	$< 18 V_{pp}$

**Table 6: Interface 'C1', Signal Levels**

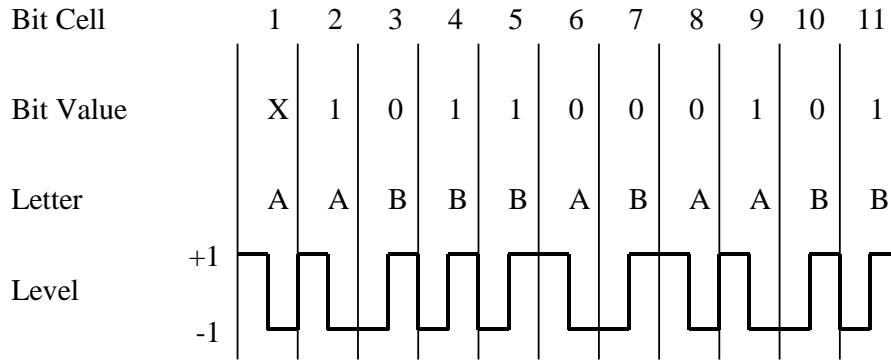
##### 5.3.2.3.2.2 Return Loss

The Return Loss (at the LEU connector) considering a resistive 120  $\Omega$  load (and that the frequency is within 0.2 MHz to 0.6 MHz) shall be better than 6 dB.

Definition of Return loss is found in clause C1 on page 140.

5.3.2.3.2.3 Waveform and Bit Coding

The signal shall be Differential Bi-Phase-Level (DBPL) coded according to Figure 18.



'X' = Don't know

**Figure 18: Differential Bi-Phase-Level coding scheme**

This means that the determination of the bit value is performed in two stages. The first stage is to translate the phase shift in the centre of each bit cell into a letter. A shift from +1 to -1 is translated into an 'A', and a shift from -1 to +1 is translated into a 'B'. The second stage is to compare the current letter with the previous one. If they are equal, the current bit value is a '1'. If they are not equal, the value is a '0'.

5.3.2.3.2.4 Mean Data Rate

The bit rate shall be: 564.48 kbit/s

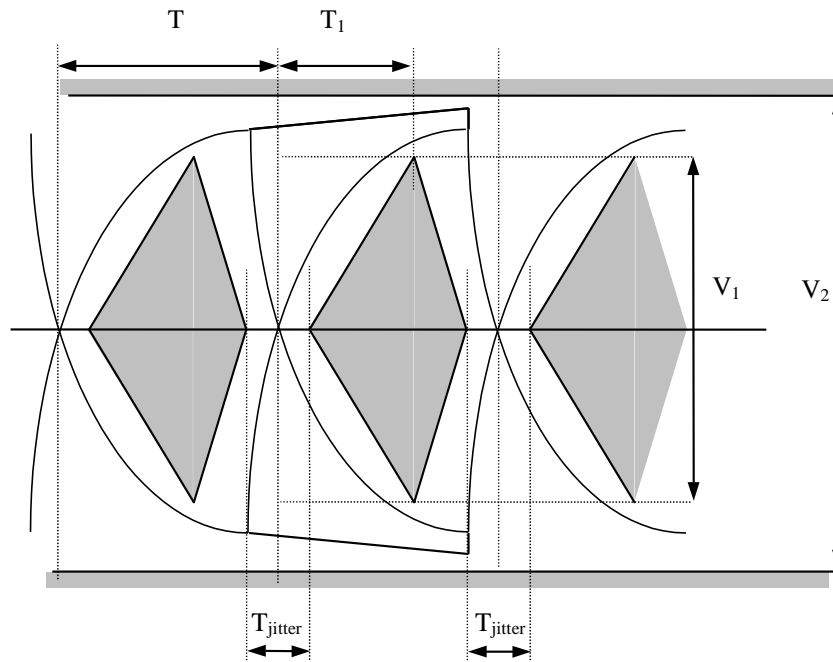
The mean data rate is defined as 1500 divided by the duration of 1500 consecutive data bits.

5.3.2.3.2.5 Mean Data Rate Inaccuracy

For any consecutive 1500 bits, the mean data rate shall be according to sub-clause 5.3.2.3.2.4, with an overall tolerance of < ±200 ppm

5.3.2.3.2.6 Eye Diagram

The signal into a resistive 120 Ω load shall fulfil the requirements according to Figure 19. The shaded areas constitute a mask into which the signal shall not enter (considering the actual mean data rate and the actual  $V_2$  signal level).



**Figure 19: Eye Diagram, Up-link**

5.3.2.3.2.7 Eye Diagram Parameters

The parameters in Figure 19 shall be according to Table 7.

Parameter	Requirement at the LEU output
$T$	$\frac{1}{2 \bullet \text{actual Mean Data Rate}}$
$T_{jitter}$	60 ns
$T_1$	$0.6 \bullet T$
$V_1$	$0.74 \bullet V_2$

**Table 7: Eye Diagram Parameters, Up-link**

5.3.2.3.2.8 Rising and Falling Edges

The 10 % to 90 % rise time and fall time, with a resistive 120 Ω load, shall be > 100 ns

#### **5.3.2.3.3 Error Detecting/Correcting Codes**

According to sub-clause 4.3 on page 36.

#### **5.3.2.3.4 Handshaking and Re-sending**

No handshaking shall be performed.

#### **5.3.2.3.5 Flow Control**

The Balise shall receive data from the Interface 'C1' at the same rate as it is sent from the LEU.

#### **5.3.2.3.6 Error Handling**

The Balise shall start transmitting the Default Telegram, at the latest after a period of time equivalent to 341 bits, when the Balise can not with sufficient quality receive a signal from Interface 'C1'.

In general, when the Balise can not detect any valid signal or valid data on the Balise controlling interface, it shall start sending the stored (Default) telegram. In particular, a continuous stream of only logical '0' or '1' shall be either transparently transmitted to Interface 'A', or cause a switch to the Default Telegram. See also second paragraph of sub-clause 4.4.6.2.3 on page 44.

This applies both to the situation when the Balise has been activated by a passing train and is ready to start sending a telegram, and to the situation when the Balise can no longer detect any valid signal on Interface 'C1' during a train passage.

Once the Balise has started sending the Default Telegram, it shall continue doing so as long as it is sufficiently energised by the train, even if there should be a resumption of valid signal on Interface 'C1'.

Each time the Balise is sufficiently energised by the train, a new decision shall be made about whether there is any valid signal on Interface 'C1'.

#### **5.3.2.4 Transmission of Messages on Application Level**

The general format shall be according to sub-clause 4.3 on page 36.



### 5.3.3 Auxiliary Energy Input (Interface ‘C6’)

#### 5.3.3.1 Functional Requirements

Interface ‘C6’ shall be present and fulfil the requirements of this sub-clause. This interface may be used for powering the Up-link serial interface input circuits of the Balise from the LEU. When Interface ‘C4’ is implemented, Interface ‘C6’ shall be used as a carrier for the blocking signal (see clause D4 of Annex D on page 143).

#### 5.3.3.2 Physical Transmission

##### 5.3.3.2.1 Transmission Medium

The signal shall be polarity independent. This means that interchanging the two inputs leads shall not affect the function of the interface.

The transmission shall be base band signals on electrical conductors.

##### 5.3.3.2.2 Electrical Data

###### 5.3.3.2.2.1 Signal Level

	Requirement at the LEU output
Signal level shall be (into a resistive 170 Ω load)	22.0 +1.0/-2.0 V <sub>pp</sub>

**Table 8: Interface ‘C6’, Signal Levels**

###### 5.3.3.2.2.2 Return Loss

The Return Loss (at the LEU connector) considering a resistive 170 Ω load (and that the frequency is within 8.820 kHz ±0.1 kHz) shall be better than 4 dB.

Definition of Return loss is found in clause C1 on page 140.

###### 5.3.3.2.2.3 Frequency

The signal shall be a sine wave at a frequency of 8.820 kHz ±0.1 kHz

###### 5.3.3.2.2.4 Harmonics

The second harmonic content of the signal from LEU shall be (measured into a resistive 170 Ω load) < -20 dBc

The RMS high frequency harmonic content of the signal from LEU shall be (measured into a 120 Ω load impedance) < -40 dBc between 0.1 and 1 MHz

## **5.3.4 Common Mode Signal Levels**

### **5.3.4.1 Conducted emission**

The induction of Up-link signal into the connected cable shall be limited so that the specific company installation rules fulfil what is stated in sub-clause 5.2.2.7 on page 65.

### **5.3.4.2 Susceptibility**

The company specific common mode immunity of the Balise controlling interface shall be sufficient so that the company specific installation rules ensure correct performance of the Balise when the cable is subjected to Tele-powering induction from the On-board Antenna Unit respecting the limits stated in sub-clause 6.6.10 on page 128.

## **5.4 Programming Principles**

The Up-link Balise should be programmable, either by means of inductive or wire transmission of energy and data between the programming equipment and the Balise.

The Balise programming principles and programming process (including also data retention) shall ensure that the safety targets as defined in sub-clause 4.4.6 on page 43 are met. The Balise manufacturer shall design the Balise so that the programming circuitry is not activated during normal operation and storage. The programming process (including tools) shall ensure that the intended telegram is programmed into each Balise.

## 5.5 RAMS Requirements

### 5.5.1 Balise functionality

#### 5.5.1.1 Overview

Table 9 below defines the functionality of the Balise, together with a linking to the top-level functionality of sub-clause 4.4.2 on page 42 and top-level hazards of sub-clause 4.4.6.3 on page 46.<sup>27</sup> Optional functions defined in sub-clause 4.1.4 on page 24 are intentionally excluded.

Balise functionality:	Related top-level functions	Related top-level hazards
Reception of Tele-powering signal	F1, F2	H1, H5, and H6 apply
Up-link signal generation	F1, F2	H1, H4, H5 and H6 apply
Data management	F2	H4, H5, and H6 apply
Mode selection at start-up	F1	H1 applies
Limitation of the Up-link field	F2, F3, F4	H7, H8, and H9 apply
Support to programming and management of operational/programming mode	F2	H4, H5, and H6 apply
Reception of data from Interface 'C'	F2	H4, H5, and H6 apply
Control of I/O characteristics	F1, F2, F3, F4	H1, H7, H8, and H9 apply
Cross-talk protection with other cables	F2, F3, F4	H7, H8, and H9 apply

**Table 9: Balise functionality and related top-level hazards**

The hazards H5 and H6 are not explicitly quantified for reasons mentioned in sub-clause 4.4.6.3. For hazard H4, see also the concept of the non-trusted channel in sub-clause 4.4.6.4 on page 47.

#### 5.5.1.2 Reception of Tele-powering signal

It includes reception of energy from the air-gap, field conformity, AC/DC conversion and input power limitation. All operational, environmental and failure conditions that could inhibit the Balise from being energised at a level higher than the one corresponding to the minimum flux level of the applicable I/O characteristic shall be regarded as hazardous situations.

---

<sup>27</sup> Only the defined functionality is mandatory, but not a specific structure or design solution.

### 5.5.1.3 Up-link signal generation

It includes modulation, control, transmission of the Up-link signal to the air-gap, and Up-link field conformity. All operational, environmental and failure conditions that could inhibit the Balise from generating the Up-link signal with electrical characteristics inside the allowed tolerances shall be regarded as hazardous situations.

### 5.5.1.4 Data Management

It includes Fixed or Default Telegram retention, data rate generation, memory management and serialisation of data. All operational, environmental and failure conditions that could inhibit the Balise from sending the intended data, at the correct rate, to the Up-link signal generation function shall be regarded as hazardous situations.

### 5.5.1.5 Mode selection at start-up

It includes detection of the current Tele-powering condition (CW, toggling, or non-toggling mode), setting up of the corresponding operational mode and control of the start-up transient. All operational, environmental and failure conditions that inhibit the Balise from properly setting the required mode and from responding within the maximum delay time shall be regarded as hazardous situations.

### 5.5.1.6 Limitation of the Up-link field

It includes the upper limitation of the Up-link signal level in the allowed operational and environmental conditions (debris, temperature etc.). All operational, environmental and failure conditions that could inhibit the Balise from limiting an Up-link signal level to lower than the maximum level of the applicable I/O characteristic shall be regarded as hazardous situations.

### 5.5.1.7 Support to programming and management of operational/programming mode

It includes switching from normal operation mode to programming mode and vice-versa, under control of an external programming tool, reception, storage and check of the programmed data. All operational, environmental and failure conditions that could generate the transmission of corrupted memory data shall be regarded as hazardous situations.

### 5.5.1.8 Reception of data from Interface 'C'

It includes the check of the quality of the incoming data and management of the switch from Interface 'C' data to Default Telegram, DBPL/NRZ decoding, management of the master clock, cross-talk protection among cables of different Balises, generation of the Blocking Signal (where applicable), and powering of the input circuitry from the Biasing Signal (including protection against leakage of energy from Interface C to the up-link transmitter circuitry, where applicable). All operational, environmental and failure conditions that could inhibit the Balise from correctly transferring the incoming data to the up-link signal generation function, or from correctly switching the telegram to be transmitted from the one at Interface C to the Default Telegram and vice-versa within a maximum allowed time, shall be regarded as hazardous situations.

#### 5.5.1.9 Control of I/O characteristics

It includes the combined control of incoming Tele-powering energy and of the Up-link signal level in the allowed operational and environmental conditions (debris, temperature etc.). All operational, environmental and failure conditions that could inhibit the Balise from transmitting an Up-link signal level higher than the minimum level, and lower than the maximum allowed level, of the applicable I/O characteristic shall be regarded as hazardous situations.

#### 5.5.1.10 Cross-talk protection

Proper instructions for allowed layouts of cables crossing the tracks in the vicinity of a Balise, issued by the Balise manufacturer, shall minimise the risk of possible cross-talk occurrence according to the requirements of sub-clause 5.7.10.7 on page 103. The rules are defined so as to avoid cross-talk when the Balise and the On-board system are correctly operating. If components fail, there is a potential risk that the rules do not protect.

The possible cross-talk effects of unintentional cables crossing the tracks in the vicinity of a Balise, with undefined layouts, are not covered at Balise level.

### 5.5.2 Reliability

See sub-clause 4.4.3 on page 42.

### 5.5.3 Availability

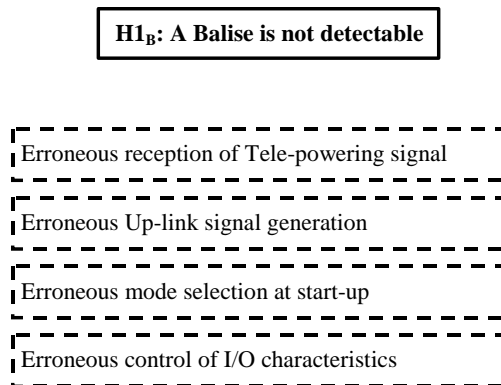
See sub-clause 4.4.4 on page 43.

### 5.5.4 Intentionally Deleted

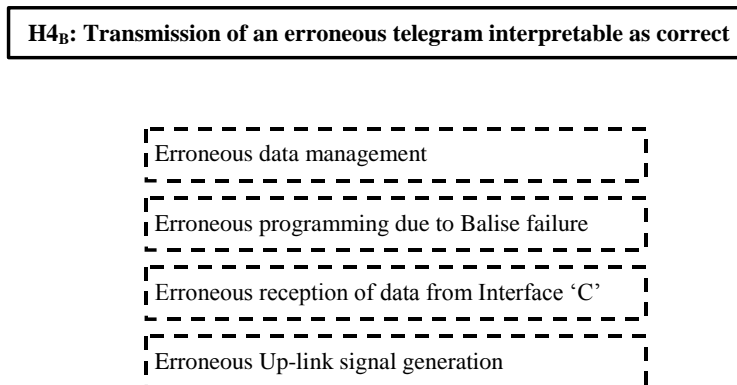
## 5.5.5 Safety

### 5.5.5.1 Hazards and Functionality

The top-level hazards defined in sub-clause 4.4.6.3 on page 46, and the related Balise functionality of Table 9 in sub-clause 5.5.1 on page 75, are apportioned and broken down as follows. How each failure contributes to the respective hazards  $HX_B$  is company specific, and dependent on implementation of suitable barriers. However, the quantification of sub-clause 5.5.5.2 on page 81 shall be fulfilled.



**Figure 20: Balise Detectability**



**Figure 21: Erroneous telegram interpretable as correct**

**H5<sub>B</sub>: Loss of telegram intended for full performance**

Erroneous data management

Erroneous programming due to Balise failure

Erroneous reception of data from Interface 'C'

Erroneous Up-link signal generation

Erroneous reception of Tele-powering signal

**Figure 22: Loss of telegram for full performance**

**H6<sub>B</sub>: No transmission of Default Telegram**

Erroneous data management

Erroneous programming due to Balise failure

Erroneous reception of data from Interface 'C'

Erroneous Up-link signal generation

Erroneous reception of Tele-powering signal

**Figure 23: No transmission of Default Telegram**

**H7<sub>B</sub>: Erroneous localisation**

Erroneous limitation of the Up-link field

Erroneous control of I/O characteristics

Erroneous cross-talk protection with other cables

**Figure 24: Erroneous Localisation**

**H8<sub>B</sub>: The order of reported Balises is erroneous**

- | Erroneous limitation of the Up-link field
- | Erroneous control of I/O characteristics
- | Erroneous cross-talk protection with other cables

**Figure 25: Order of reported Balises is erroneous**

**H9<sub>B</sub>: Erroneous reporting of Balises in a different track**

- | Erroneous limitation of the Up-link field
- | Erroneous control of I/O characteristics
- | Erroneous cross-talk protection with other cables

**Figure 26: Reporting of Balises in a different track**



### 5.5.5.2 Quantification

Table 10 defines the requirements that shall be fulfilled for the Balise hazards of sub-clause 5.5.5.1 on page 78, when assuming that the specified maintenance is fulfilled.

No.	Hazard Description	One Balise	One Balise	Two or several consecutive Balises <sup>28</sup>
		Q	$\lambda$ [f/h]	$\lambda$ [f/h]
H1 <sub>B</sub>	A Balise is not detectable	$2 \cdot 10^{-5}$	-	$10^{-9}$
H4 <sub>B</sub>	Transmission of an erroneous telegram interpretable as correct	-	-	-
H5 <sub>B</sub>	Loss of the telegram, from a certain Balise, intended for full performance	-	-	-
H6 <sub>B</sub>	No transmission of Default Telegram in case of wayside failures	-	-	-
H7 <sub>B</sub>	Erroneous localisation of a Balise with reception of valid telegram	See Annex F and the note below.		
H8 <sub>B</sub>	The order of reported Balises, with reception of valid telegram, is erroneous <sup>29</sup>	See Annex F and the note below.		
H9 <sub>B</sub>	Erroneous reporting of a Balise in a different track, with reception of valid telegram	See Annex F and the note below.		

**Table 10: Quantification for Balise**

Note: The overall system requirements on a cross-talk THR of  $10^{-9}$  f/h stated in UNISIG SUBSET-091 shall be respected considering the mandatory On-board requirements stated in sub-clause 6.4.5.2 on page 120 and the methodology of Annex F.

The hazards H7<sub>B</sub>, H8<sub>B</sub>, and H9<sub>B</sub> are caused by failures in the Balise (too strong Up-link signal).

Quantification of Hazard H4<sub>B</sub> is not applicable, because covered by the non-trusted channel (see sub-clause 4.4.6.4 on page 47).

The figures might originate from a hardware failure, and is thus dependent on MTTR (including the detection time) and the actual failure frequency. The combination of these aspects is the sums quantified in Table 10 above. <sup>30</sup>

The hazards H5<sub>B</sub> and H6<sub>B</sub> are not explicitly quantified for reasons mentioned in sub-clause 4.4.6.3 on page 46.

<sup>28</sup> Only two Balises are currently commonly evaluated.

<sup>29</sup> One Balise has been virtually moved (e.g., due to longitudinal cross-talk) so that the order of Balises becomes erroneous.

<sup>30</sup> In which relation those hazards are related to safety is determined by hazard analyses on higher system level.

### 5.5.5.3 Independence of hazard causes

For some of the hazards, dependencies also have to be considered when calculating the figures of Table 10 on page 81.

It is assumed that there is negligible common cause factor (CCF) for the case that two or several consecutive Balises are affected within the hazards H4<sub>B</sub>, H5<sub>B</sub> and H6<sub>B</sub>. If this is proven not true, then this aspect shall be separately analysed.

Crosswise unavailability of each type of hazard is independent between the On-board Transmission Equipment and the Balise.

Effects of faults shall be analysed assuming additional noise from the air-gap. Any ratio of random decoded bit error rate shall be analysed, assuming that the On-board Transmission Equipment uses the reference receiver (see sub-clause 4.3.4 on page 41).

### 5.5.5.4 Conditions/Assumptions

The apportionment of the figures of Table 10 on page 81 is based on the following presumptions:

- The Mean Time to Restore (MTTR) is 10 hours.
- The dependencies with air-gap related aspects shall be considered. See sub-clause 4.4.6.5 on page 48.
- H5<sub>B</sub> and H6<sub>B</sub> means that a physical Balise is either detectable or undetectable, and that the telegram in question is corrupted and/or not transmitted (i.e., H5<sub>B</sub> and H6<sub>B</sub> are always more probable than H1<sub>B</sub>).
- The H6<sub>B</sub> probability is conditional that wayside failures are present (H5<sub>B</sub> expresses the probability for wayside failures).
- Erroneous localisation in H7<sub>B</sub> means that the requirements of sub-clause 4.2.10.2 on page 35 are not fulfilled.
- Only random aspects are included.
- All figures are based on mean restore times. The analyses should be supported by sensitivity analyses wherever deemed necessary.

The following aspects are not within the scope of the quantification of Table 10 on page 81:

- Vandalism
- Exceptional occurrences (e.g., exceptional environmental conditions outside specification, like lightning effects out of specification)
- Erroneous installation
- Erroneous maintenance
- Programming with erroneous telegrams (i.e., a non-intended telegram is programmed into a Balise)
- Occupational Health
- Mechanical damage due to maintenance (causing conditions outside specification)

The quantification should, as far as possible, be based on data acquired by experience. If such data is not available, data from MIL-HDBK 217 or other similar recognised database should be used. Data may be tailored considering manufacturer experience (if available), but explicit justifications are required.

## 5.6 Installation Requirements for Balises

### 5.6.1 Reference Axes

See sub-clause 4.5 on page 50.

### 5.6.2 General Installation Requirements for Balises

#### 5.6.2.1 Height Tolerances for Balise Mounting

The following Balise mounting heights apply:

	Debris layer	The distance from top of rail to reference marks, $Z_b$ : <sup>31</sup>
Highest position of any Balise:	Class A and B	-93 mm
Lowest position of Standard Size Balise:	Class A	-190 mm
	Class B	-210 mm
Lowest position of Reduced Size Balise (transversal and longitudinal mounting):	Class A	-150 mm
	Class B	-193 mm

**Table 11: Balise Mounting Heights**

The debris layers Class A and Class B are defined in sub-clause 5.7.9 on page 92. All debris classes shall be considered for the highest position of any type of Balise.

Balises can be classified by the supplier to Class A or Class B. When a Balise of one class is mounted to a height corresponding to another class then the less severe class of the two is valid for this Balise, where the Class A is the most severe and Class B the less severe class.

Each design of Antenna Unit shall for interoperability reasons be able to handle each kind of Balise mounting stated above. It shall always take into consideration the most severe debris layer class.

According to the definition of reference area for the Balise the influence of debris affects the transmission in two ways:

1. The input to, and the output from, a Balise are measured in the reference area that is covered by debris.
2. The input to, and the output from, an Antenna Unit are measured in the reference area that is covered by debris.

---

<sup>31</sup> As the  $Z_b$  values refer to the reference marks, the bottom of a Balise will usually be lower. In situations where the mounting surface is too low, in order not to exceed the maximum  $Z_b$  value, a distance block of a non-conductive material shall be put between the Balise and the mounting surface.

### 5.6.2.2 Distance from Top of Rail to Balise Reference Mark

The following table defines the applicable range of distances (in mm) from Top of Rail to the Balise reference mark for different combinations of the applicable debris class for the actual application and the Balise class.

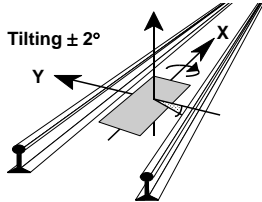
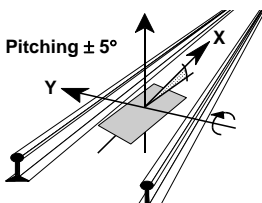
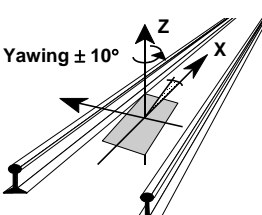
Balise Size	Balise Class	Debris Class in Application	
		A	B
<b>Standard</b>	<b>A</b>	<b>-93 to -190</b>	<b>-93 to -210</b>
Standard	B	Not allowed	-93 to -210
Reduced	A	-93 to -150	-93 to -193
<b>Reduced</b>	<b>B</b>	Not allowed	<b>-93 to -193</b>

**Table 12: Mounting height versus Balise Class**

Preferred combinations are marked with **bold** text.

### 5.6.2.3 Lateral and Angular Tolerances for Balise Installation

The lateral and angular tolerances apply to both the Standard Size and Reduced Size Balises. The reference axes and angles are described in sub-clause 4.5 on page 50.

The maximum lateral deviation between the Z reference marks of the Balise and the centre axis <sup>32</sup> of the track:	$\pm 15$ mm	Tolerance for general applications.
Provided that the track curve radius is $\geq 1000$ m and the Maximum Permitted Speed is $\leq 180$ km/h the lateral deviation from the centre axis <sup>32</sup> of the track may be:	$\pm 40$ mm	Tolerance to be used only when the layout of the track does not allow for the general application tolerance.
Provided that the track curve radius is $\geq 1000$ m, the Maximum Permitted Speed is $\leq 180$ km/h and the Balise is installed 40 mm higher than otherwise allowed, the lateral deviation from the centre axis <sup>32</sup> of the track may be:	$\pm 80$ mm	Tolerance to be used only when the layout of the track does not allow for the general application tolerance.
Allowed tilting of the Balise (Tb), related to the Y-axis:	$\pm 2^\circ$	
Allowed pitching of the Balise, related to the X-axis:	$\pm 5^\circ$	
Allowed yawing of the Balise, related to the X-axis:	$\pm 10^\circ$	

Note: In case of multi-rail track, where one or more track(s) are operated with ETCS, one Balise can be installed serving several tracks as long as the installation of the Balise is in accordance with the rules above when each track is considered individually. Where it is not possible for one Balise to serve several tracks, several Balises can be installed, where each Balise serves one track, as long as each Balise is installed according to the above rules for the track it is intended to serve. In case several Balises are installed as described, a Balise may or may not be read/detected if installed outside the limits defined above, with reference to the track on which the train is running.

<sup>32</sup> The centre axis of the track is located half the distance between the webs of the rails. The value of the lateral tolerance does not include the influence from lateral rail wear (this shall instead be considered in the dynamic displacement of the Antenna Unit).

### 5.6.3 Distance between Balises

The minimum distance between two consecutive Balises shall be 2.3 m from centre to centre, on lines with a Maximum Permitted Speed of 180 km/h. <sup>33</sup>

An exception to the general rule above is that the minimum distance between two consecutive Standard Size Eurobalises shall be 2.6 m from centre to centre, on lines with a Maximum Permitted Speed of 180 km/h. <sup>33</sup>

The minimum distance between two consecutive Balises shall be 3.0 m from centre to centre, on lines with a Maximum Permitted Speed of 300 km/h.

The minimum distance between two consecutive Balises shall be 5.0 m from centre to centre, on lines with a Maximum Permitted Speed of 500 km/h.

The minimum distances between Eurobalises are visualised as shown in Figure 27 and Figure 28 below.

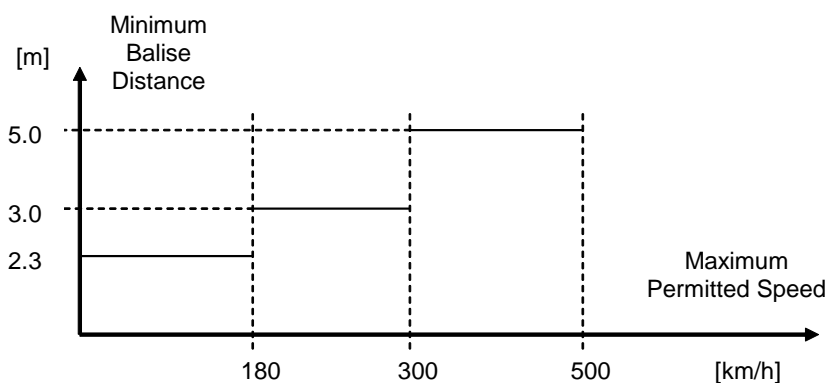


Figure 27: Minimum Distance Between Reduced Size Eurobalises

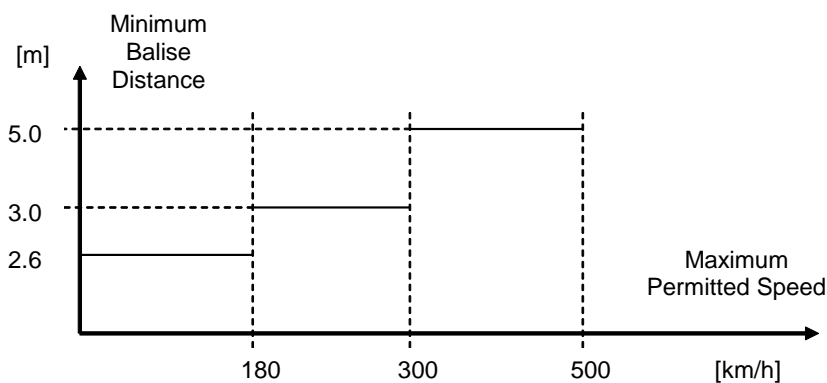


Figure 28: Minimum Distance Between Standard Size Eurobalises

For information on distance between clusters of Balises, see sub-clause 4.2.9 on page 33.

### 5.6.4 Number of Balises in a Balise Group

The number of Balises in a Balise group shall be as defined in SUBSET-026, SUBSET-040, and SUBSET-091.

<sup>33</sup> If the distance is closer, then there is a risk for cross-talk in the side lobes from the respective Up-link Balises. Additionally, the timing constraints for the On-board Transmission Equipment are affected.

## 5.6.5 Balise Installation in Narrow Curves

### 5.6.5.1 General

In general, this specification applies for the minimum horizontal curve radius 300 m and the minimum vertical curve radius 9000 m. This sub-clause (5.6.5) defines restrictions required in case Balise installation in more narrow curves is needed.

### 5.6.5.2 Engineering Rules

For each combination of vertical (convex or concave) and horizontal curvature, the set of installation restrictions are defined in Table 13 below. The detailed restrictions are defined in sub-clause 5.6.5.3 below.

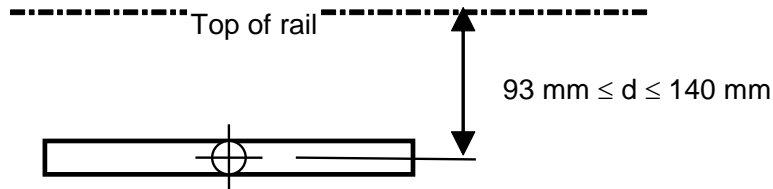
Horizontal Radius	$R \geq 300$ m	$300 \text{ m} > R \geq 260$ m	$260 \text{ m} > R \geq 200$ m	$200 \text{ m} > R \geq 180$ m
Vertical Radius				
$R \geq 9000$ m	No additional limitations	5.6.5.3.1 5.6.5.3.2 5.6.5.3.3 5.6.5.3.4 5.6.5.3.6	5.6.5.3.1 5.6.5.3.2 5.6.5.3.3 5.6.5.3.5 5.6.5.3.6	5.6.5.3.1 5.6.5.3.2 5.6.5.3.3 5.6.5.3.5 5.6.5.3.6 5.6.5.3.7
$9000 \text{ m} > R \geq 3000$ m	5.6.5.3.9	5.6.5.3.1 5.6.5.3.2 5.6.5.3.3 5.6.5.3.4 5.6.5.3.6 5.6.5.3.9	5.6.5.3.1 5.6.5.3.2 5.6.5.3.3 5.6.5.3.5 5.6.5.3.6 5.6.5.3.9	5.6.5.3.1 5.6.5.3.2 5.6.5.3.3 5.6.5.3.5 5.6.5.3.6 5.6.5.3.7 5.6.5.3.9
$3000 \text{ m} > R \geq 2000$ m	5.6.5.3.9	Not supported	Not supported	Not supported
$2000 \text{ m} > R \geq 1100$ m	5.6.5.3.8 5.6.5.3.9	Not supported	Not supported	Not supported
$R < 1100$ m	Not supported	Not supported	Not supported	Not supported

**Table 13: Installation Restrictions versus Curve Radii**

### 5.6.5.3 Installation Restrictions

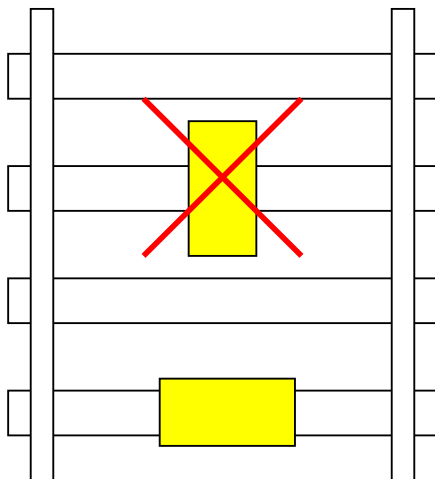
#### 5.6.5.3.1 Vertical Installation Height

The vertical installation height of the Balise shall be within the interval between 93 mm and 140 mm below the top of rail.



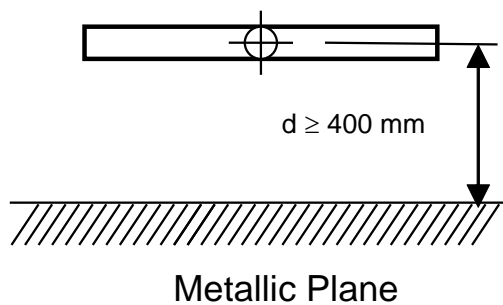
#### 5.6.5.3.2 Longitudinal Installation

Longitudinal installation of the Reduced Size Balise is not allowed.



#### 5.6.5.3.3 Metallic Plane

There shall be no metallic plane closer than 400 mm below the Balise.





#### 5.6.5.3.4 Maximum Permitted Speed 1

The highest permitted speed is 100 km/h.

#### 5.6.5.3.5 Maximum Permitted Speed 2

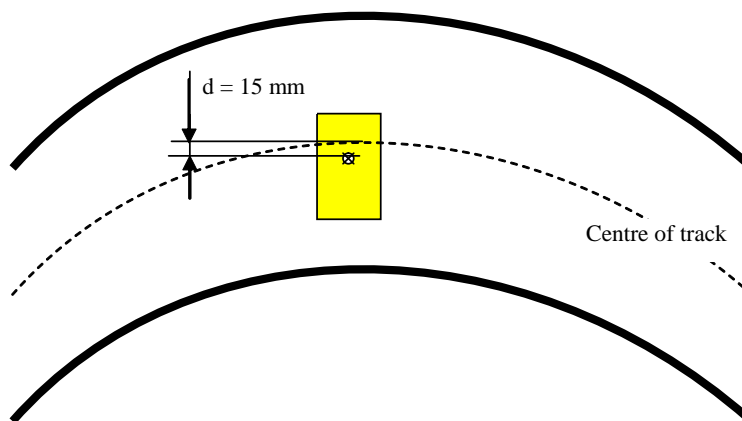
The highest permitted speed is 85 km/h.

#### 5.6.5.3.6 Steel Sleeper

Balise mounting on steel sleepers is not allowed.

#### 5.6.5.3.7 Balise Displacement

The Balise shall be displaced 15 mm towards the centre of the curve. Installation tolerances according to “general applications” in section 5.6.2.3 apply.



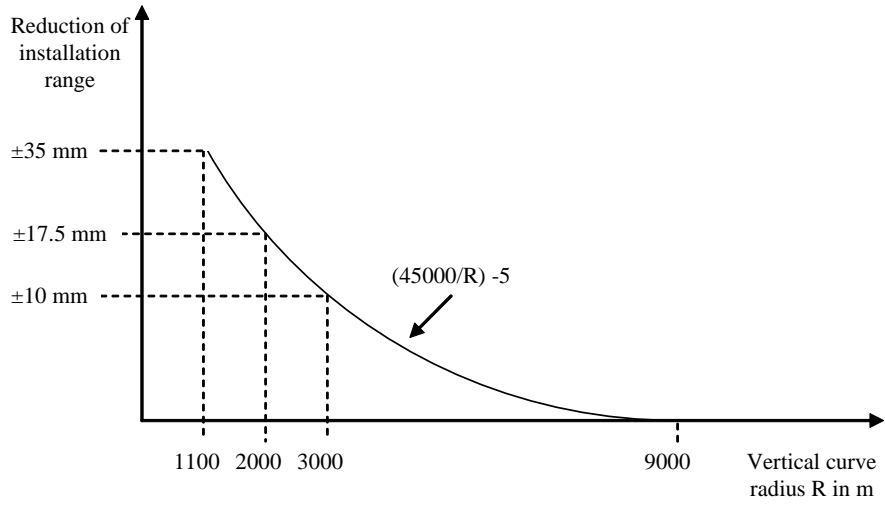
#### 5.6.5.3.8 Debris

Debris Class A application is not allowed.

#### 5.6.5.3.9 Reduction of Vertical Installation Interval

For vertical radius R between 1100 m and 9000 m, the reduction shall be  $((45000/R) - 5)$  mm applicable to both the highest and the lowest allowed installation height (in order to cope with both convex and concave curvature and antenna installation in the front of and in the rear of the bogie).

The following figure illustrates how much the installation range shall be reduced as a function of vertical curve radius (e.g., for a vertical curve radius of 3000 m combined with a horizontal curve radius of less than 300 m, the allowed installation range is between 103 mm and 130 mm below the top of rail).



## **5.7 Specific Environmental Conditions for Balises**

### **5.7.1 Operational Temperature**

The Balise shall fulfil one of the classes of sub-clause 4.3 (Temperature) of EN 50125-3.

### **5.7.2 Storage**

During transit and storage, i.e., within a maximum of two weeks, the Balise should not be damaged by exposure to ambient temperatures in the following range:

$$T_{\min} = -40 \text{ }^{\circ}\text{C} \text{ }^{34}$$

$$T_{\max} = +85 \text{ }^{\circ}\text{C}$$

The Balise should be designed to be held in storage for a maximum period of 5 years without any requirement for test and inspection. During such storage, the ambient temperature should not exceed the following range: <sup>35</sup>

$$T_{\min} = +15 \text{ }^{\circ}\text{C}$$

$$T_{\max} = +35 \text{ }^{\circ}\text{C}$$

### **5.7.3 Sealing, Dust and Moisture**

The Balise enclosures should be designed as to allow correct operation at the IP67 environmental rating as defined in EN 60529.

All exposed modules and sub-assemblies used in the Eurobalise equipment should be sealed against the effects of moisture, mould growth and contamination.

### **5.7.4 Mechanical Stress**

The Balise shall fulfil applicable parts of sub-clause 4.13 (Vibration and Shocks) of EN 50125-3.

### **5.7.5 Meteorological Conditions**

The Balise shall fulfil applicable parts of sub-clauses 4.4 (Humidity), 4.5 (Wind), 4.6 (Rain), 4.7 (Snow and Hail), 4.8 (Ice), and 4.9 (Solar Radiation) of EN 50125-3.

### **5.7.6 Lightning**

The Balise shall as a minimum fulfil item 1.5 of Table 1, and item 2.3 of Table 2, in EN 50121-4.

### **5.7.7 Chemical Conditions**

The Balise shall fulfil applicable parts of sub-clause 4.11 (Pollution) of EN 50125-3.

---

<sup>34</sup> A lower temperature can be specified for specific products that do not contain components that are only specified for a minimum temperature of -40 °C.

<sup>35</sup> This requirement is a minimum requirement that every manufacturer shall fulfil. Other storage temperatures can be considered in addition to these requirements for a specific customer.

### 5.7.8 Biological Conditions

The Balise shall fulfil applicable parts of sub-clause 4.11 (Pollution) of EN 50125-3.

### 5.7.9 Debris

The debris shall be applied on the Balise under test in accordance with sections B5.2.2 and B5.2.3 of SUBSET-085.

The following Table 14 specifies the debris on the Balise, and the corresponding Classes A and B.

Material	Description	Layer on top of Balise, [mm]	
		Class B	Class A
Water	Clear	100	200
	0.1 % NaCl (weight)	10	100
Snow	Fresh, 0 °C	300 (Note <sup>36</sup> )	300 (Note <sup>36</sup> )
	Wet, 20 % water	300 (Note <sup>36</sup> )	300 (Note <sup>36</sup> )
Ice	Non porous	100	100
Ballast	Stone	100	100
Sand	Dry	20	20
	Wet	20	20
Mud	Without salt water	50	50
	With salt water, 0.5 % NaCl (weight)	10	50
Iron Ore	Hematite (Fe <sub>2</sub> O <sub>3</sub> )	20	20
	Magnetite (Fe <sub>3</sub> O <sub>4</sub> )	2	20
Iron dust <sup>37</sup>	Braking dust	10	10
Coal dust	8 % sulphur	10	10
Oil and Grease		50	50

**Table 14: Debris layers on top of the Balise and its Classes.**

A Class A Balise is a Balise fulfilling the requirements of this specification when applying Class A debris conditions, and a Class B Balise is a Balise fulfilling the requirements of this specification when applying Class B debris conditions.

<sup>36</sup> 300 mm or up to the bottom of the Antenna Unit.

<sup>37</sup> A non-conductive mixture of grease and iron oxide which is normally encountered in the Railway environment.

The flux levels  $\phi_{d1}$  and  $\phi_{d2}$  of sub-clause 5.2.2.6 on page 63 shall be increased when the Balise is subjected to some debris conditions. The flux increase shall be in accordance with Table 15 below for the  $\phi_{d1}$  and  $\phi_{d2}$  levels.

Material	Description	Flux increase, [dB]	
		Class B	Class A
Water	Clear	2.0	3.0
	0.1 % NaCl (weight)	1.0	2.5
Iron Ore	Magnetite (Fe <sub>3</sub> O <sub>4</sub> )	1.0	2.0

**Table 15: Flux Increase ( $\phi_{d1}$  and  $\phi_{d2}$  levels).**

The influence of debris affects the transmission in two ways:

1. The Input /Output characteristics of the Balise (e.g., the tuning of the Balise) are affected.
2. The mutual coupling between Balise and Antenna Unit is affected.

The Balise should have a Balise Class A or B based on the influence corresponding to item 1 above.

There shall be a clear marking that identifies the Balise Class of the Balise.

## 5.7.10 Metallic Masses and Cables in proximity

### 5.7.10.1 Metal Free Volume

A Balise shall be mounted in such a way that metal, except for the approved mounting details, is avoided in a cubic volume around the Balise, as shown in Figure 29 and Figure 30. The limits to the sides and downwards (in the directions X, Y, and Z) refer to the reference marks of the Balise. The origin of this co-ordinate system is the centre of a right angle reference system passing through the reference marks of the Balise. Upwards, in the Z-direction, the metal free volume shall extend above the Balise limited only by the vertical track clearance. Electrically closed horizontal loops are not allowed around or above the Balise at the limits of the defined metal free zone.

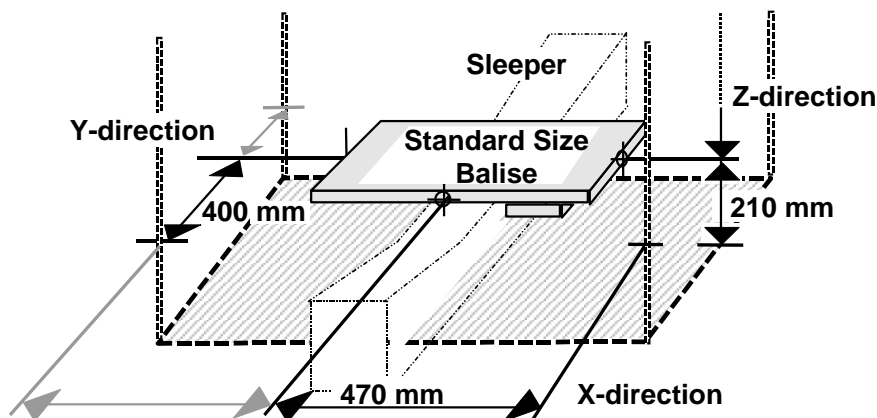


Figure 29: Metal free volume for Standard Size Balise

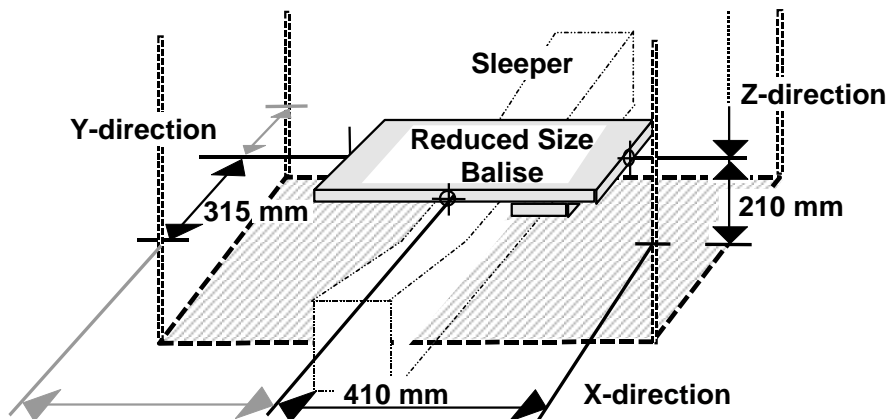


Figure 30: Metal free volume for Reduced Size Balise

These limits of the metal free volume apply to normal operation situations. For transversal mounting of the Reduced Size Balise Figure 30 applies 90° rotated, so that the free space in the Y direction is 410 mm and the free space in the X direction is 315 mm.

When such a metal free volume cannot be found, the mounting height shall be adjusted according to sub-clause 5.7.10.5 on page 100.

The influence from concrete and bi-block sleepers shall be allowed for in the overall tolerances for the Balise. This means that no compensation of the height shall be needed for these types of sleeper.

### 5.7.10.2 Mounting to Steel Sleeper

The requirements of this sub-clause are optional, and apply only to products intended to be used during such conditions.

For steel sleepers the specified mounting height  $Z_b$  shall be adjusted for the amount of iron masses near the Balise.

The Standard Size Balise shall be mounted with its reference marks at a distance of at least 45 mm above the top of a steel sleeper. The lowest position of the Standard Size Balise ( $Z_b$ ) in sub-clause 5.6.2.1 on page 83 will therefore be raised by 45 mm. The highest position of the Balise shall be 93 mm below the top of rail.

The Reduced Size Balise shall be mounted with its reference marks at a distance of at least 60 mm above the top of a steel sleeper. The lowest position of the Reduced Size Balise ( $Z_b$ ) in sub-clause 5.6.2.1 on page 83 will therefore be raised by 60 mm. The highest position of the Balise shall be 79 mm below the top of rail for  $-160 \text{ mm} \leq Z \leq -139 \text{ mm}$ , otherwise 93 mm below the top of rail.

Please observe that the highest position of the steel sleeper is 139 mm below the Top of Rail.

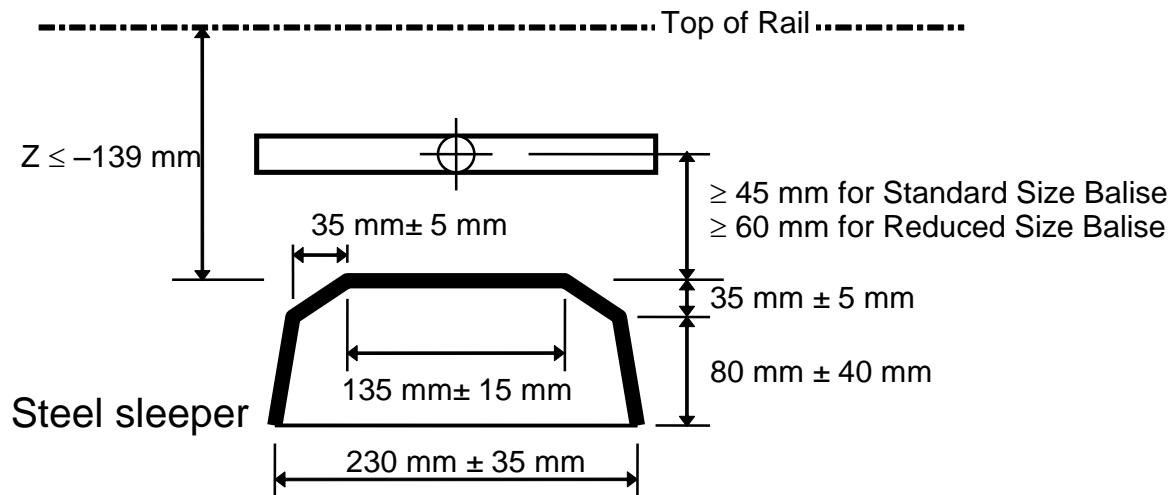


Figure 31: Balise mounted to a steel sleeper

### 5.7.10.3 Mounting to Other Sleeper

The size of metallic mounting assemblies shall be restricted when mounting a Balise to other than steel sleepers. When viewing the metallic mounting assemblies in the Z-direction, the total area in the X/Y plane of projection shall not exceed:

- 300 cm<sup>2</sup> for a Standard Size Balise.
- 140 cm<sup>2</sup> for a Reduced Size Balise, transversal mounting.
- 140 cm<sup>2</sup> for a Reduced Size Balise, longitudinal mounting.

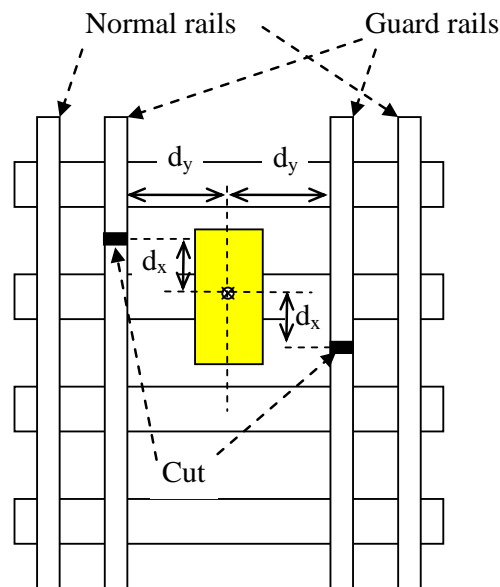
The mounting assembly and the reinforcement of a concrete sleeper should not create or have the form of conductive loops. If they do, the requirements stated in the sub-clauses 5.7.10.1 and 5.7.10.2 apply. The mounting assembly and reinforcement, and the exact positions and forms of metallic mounting assemblies that are allowed, should be specified by the manufacturer of the Balise.



## 5.7.10.4 Guard Rails

### 5.7.10.4.1 Laterally displaced Guard Rails

As an exception to the metal free area as defined in section 5.7.10.1, guard rails may be located in the metal free area under the following conditions. For ensuring both cross-talk protection and reliable transmission, guard rails in the vicinity of Balises shall be cut, leaving gaps of at least 20 mm. Such a cut shall be done within  $\pm 300$  mm in the X-direction from the Z reference mark of the Balise (see distance  $d_x$  in Figure 32 below).<sup>38</sup>



**Figure 32: Laterally Displaced Guard Rails**

In the Y-direction, measured from the Z reference mark of the Balise, the distance shall be at least (the guard rails may be positioned on either or both sides of the Balise):

- $d_y \geq 300$  mm for the Standard Size Balise,
- $d_y \geq 320$  mm for the Reduced Size Balise, transversal mounting,
- $d_y \geq 220$  mm for the Reduced Size Balise, longitudinal mounting. At a level of 100 mm above the X and Y reference marks, the distance shall be at least 190 mm.<sup>39</sup>

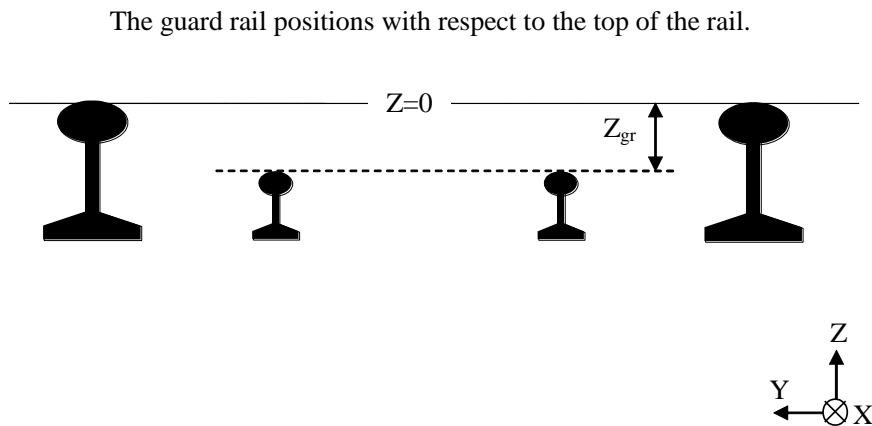
If a guard rail is not parallel with the Balise, the shortest distance to the guard rail along the entire Balise applies. The meaning with gaps above is that it is either free air, or filled with dielectric material.

<sup>38</sup> In rare circumstances (e.g., unfavourable combinations of the length of the guard rail related to the wave propagation properties), full intrinsic cross-talk protection can not be guaranteed on a single Balise level. However, additional protection is ensured on system level (such as balise groups with multiple Balises, linking, etc.).

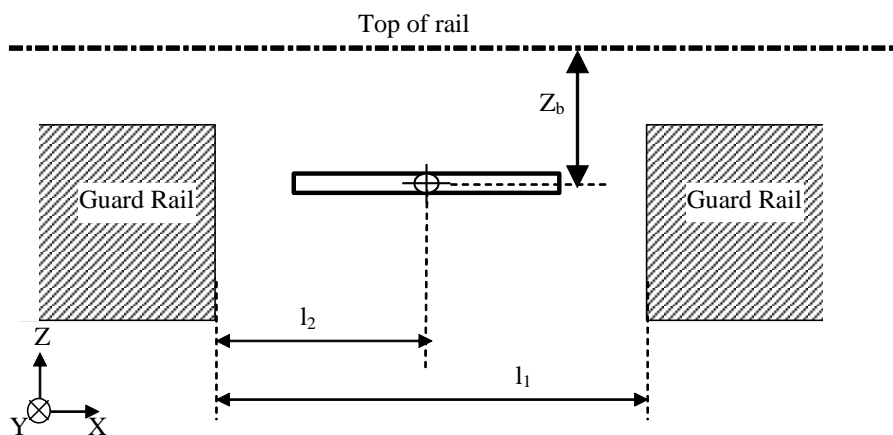
<sup>39</sup> This allows for cutting one side of the rail foot but leaving the rail head intact.

### 5.7.10.4.2 Centrally positioned Guard Rails

In some applications there are two guard rails centrally positioned in the track that without any precaution would pass through the metal free area as defined in section 5.7.10.1. Where Balises are supposed to be installed, there shall be gaps in the guard rails to respect the metal free area as defined in section 5.7.10.1. The following defines the allowed installation cases.



Balise positioning and gap in guard rails



**Figure 33: Centrally positioned Guard Rails**

The following distances apply to allowed configurations:

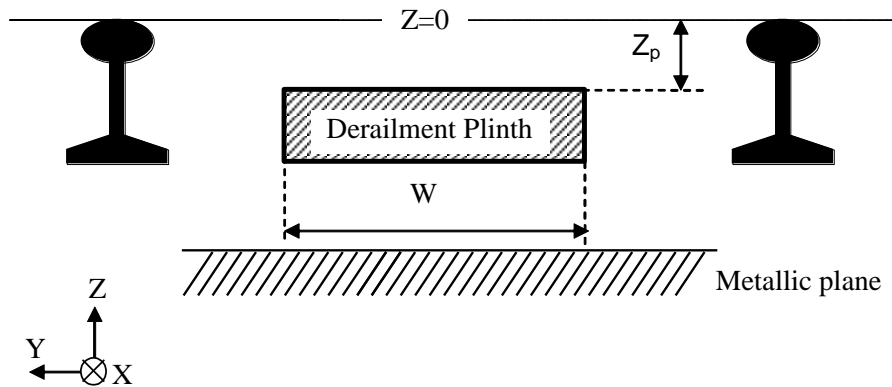
- $Z_{gr} \geq 0$  mm
- $Z_b$  shall fulfil the defined installation rules for Balises
- $l_1 \geq 0.94$  m
- $l_2 \geq 0.47$  m

In case  $Z_{gr} \leq 50$  mm, the total width of the upper vertical projection of the guard rails shall not exceed 200 mm in order to respect the requirements of section 6.5.2 (i.e., the foots of the guard rail may be wider).

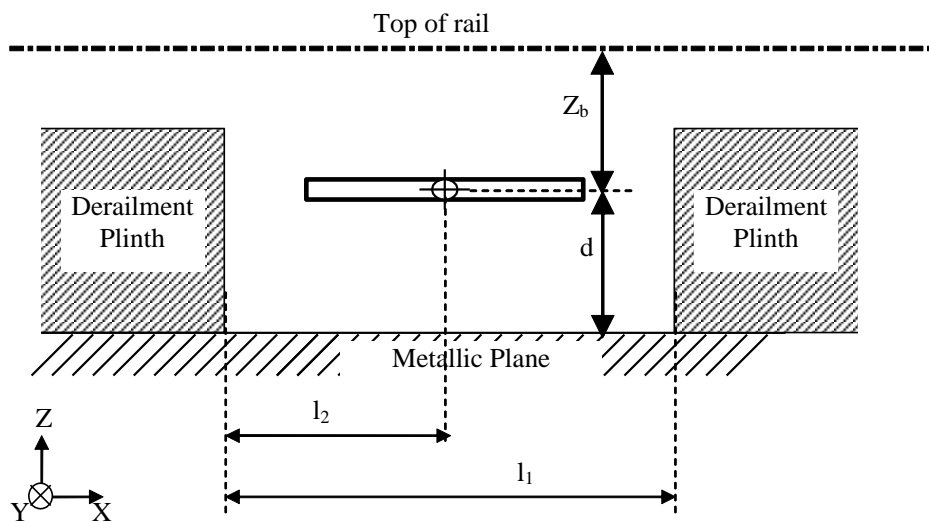
### 5.7.10.4.3 Derailment plinth

In some applications there is a concrete derailment plinth (with metallic reinforcement) positioned in the middle of the track. Where Balises are supposed to be installed, there is a gap in the derailment plinth. The following defines the allowed installation cases.

Metallic reinforcement position of the derailment plinth with respect to the top of the rail



Balise positioning and gap in derailment plinth



**Figure 34: Derailment Plinth**

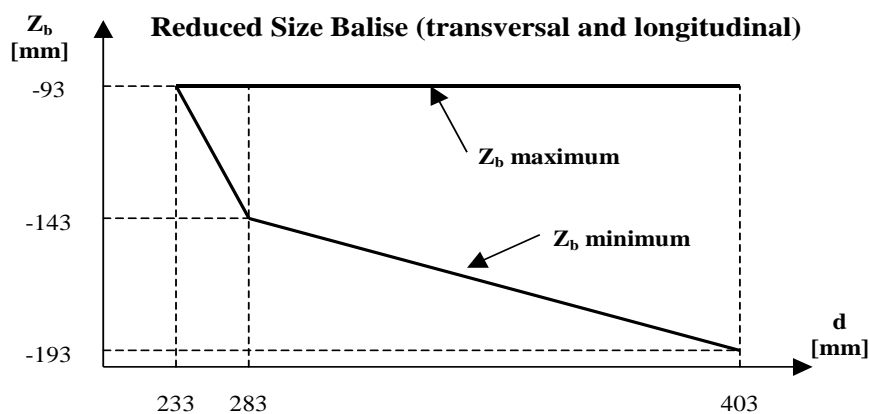
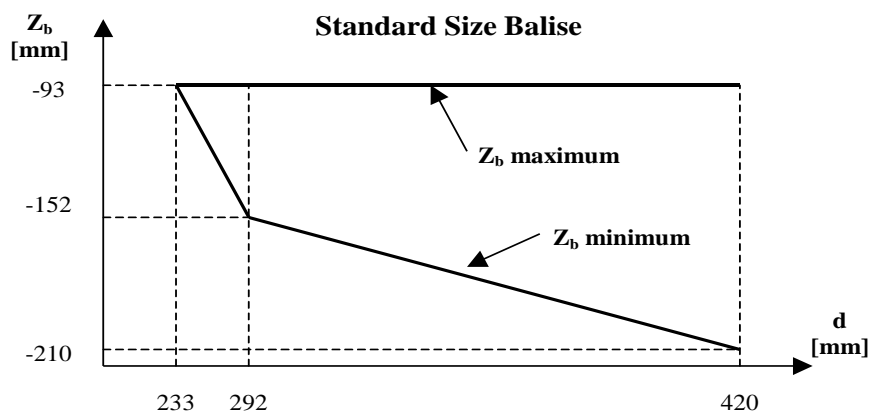
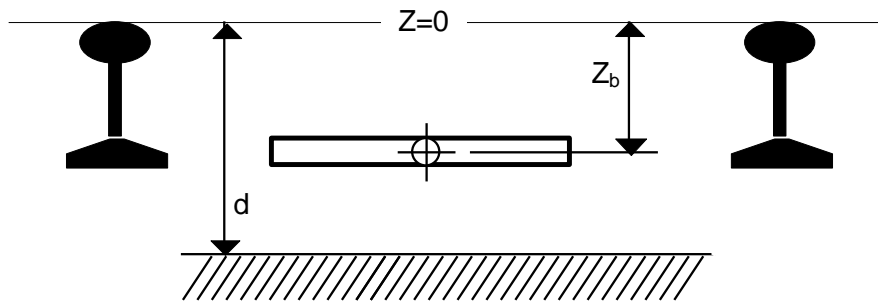
The following distances apply to allowed configurations:

- $Z_p \geq 80$  mm
- $W \leq 500$  mm
- $93 \text{ mm} \leq Z_b \leq 138$  mm
- $d \geq 140$  mm
- $l_1 \geq 1$  m
- $l_2 \geq 0.5$  m

### 5.7.10.5 Other interfering Conductive Material

If the surface below the Balise contains a conductive structure such as a metal sheet or a net of conductors that are connected in the crossing points <sup>40</sup>, and this metal is closer than 210 mm, then the mounting height  $Z_b$  must be adjusted. The mounting height  $Z_b$  and the distance  $d$  refer to the actual top of rail ( $Z=0$ ), for which the rail wear shall be considered.

The Balise mounting height ( $Z_b$ ) from the top of rail to the reference mark in the presence of a metal structure.



**Figure 35: Mounting heights for Balise in proximity to metal structure**

<sup>40</sup> It is common that iron reinforcement in concrete track beds forms a net of conductors that are connected in the crossing points.

### 5.7.10.6 Mounting in the extreme vicinity of Metal Planes

For mounting in the extreme vicinity of metallic planes, the specified mounting height shall be adjusted for the amount of metal masses near the Balise.

The requirements of this sub-clause are optional, and only apply to products intended to be used during the following conditions.

It is allowed that specifically tuned Balises are used in combination with this specific installation condition <sup>41</sup>.

Please observe that this specific installation case imposes that the Balise may be mounted higher than the general rule for the highest allowed Balise mounting defined in sub-clause 5.6.2.2 on page 84. In this case, the implication is that the below-defined case shall always include the metallic plane at the defined distance to the Balise when the limitations of sub-clause 5.6.2.2 on page 84 are violated. It is in this case also required that the metallic plane is significantly larger than the Balise <sup>42</sup>, and that it is centred with respect to the Balise reference marks. For testing purposes, the definitions of SUBSET-085 that correspond to sub-clause 5.7.10.5 on page 100 herein apply also to this case, except that the specific distances defined below shall be used.

The basic requirement is that the metallic plane may be positioned as high as 186 mm below the Top of Rail. For mounting conditions with the metallic plane more than 233 mm below the Top of Rail, see sub-clause 5.7.10.5 on page 100.

The distance between the Balise and the Top of Rail,  $Z_b$ , shall be in accordance with Figure 37 or Figure 38 below.

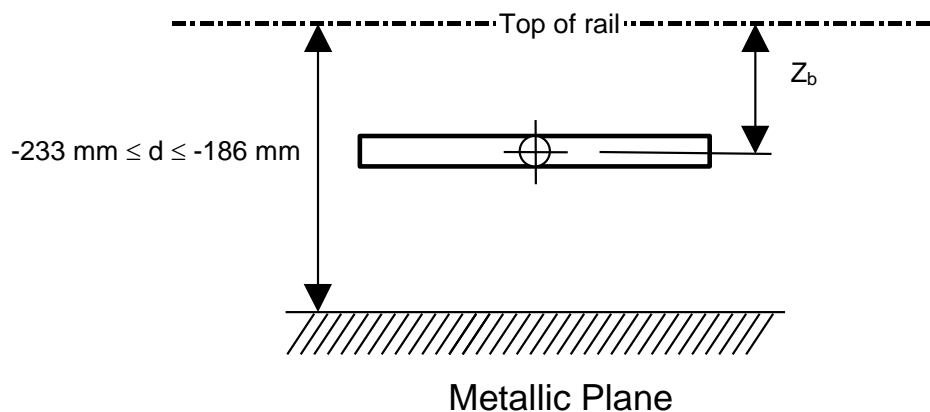
Regarding the lateral deviation of the Balise, the installation requirements for general applications in sub-clause 5.6.2.3 on page 85 apply.

This installation condition shall only be applied where the track curve radius is more than 1000 m.

For this installation condition, only short telegrams shall be used for Maximum Permitted Speed above 300 km/h (applies to both Standard Size Balises and Reduced Size Balises).

For this installation condition, a Maximum Permitted Speed of 180 km/h applies for the transversally mounted Reduced Size Balise.

It is not allowed to combine the use of toggling modulation with this specific installation.



**Figure 36: Balise mounted in the extreme vicinity of Metal Planes**

<sup>41</sup> In such cases, since the metal plane can be regarded as an integral part of the Balise, all applicable requirements shall be fulfilled in the presence of the metallic plane, with the exception of Field Conformity, in which free air conditions apply.

<sup>42</sup> This installation case does not apply to reinforcement in concrete, which is considered covered by sub-clause 5.7.10.5 on page 108. This case typically applies to metal bridges or other solid metal surfaces.

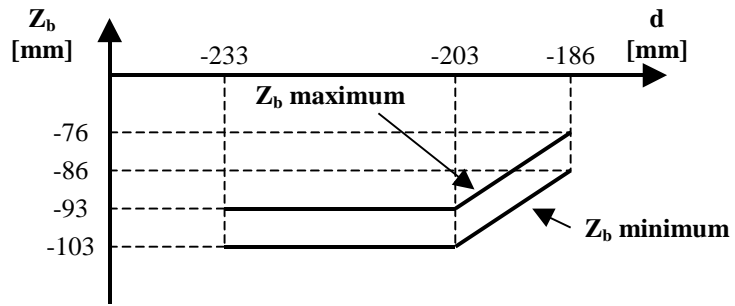


Figure 37: Mounting height, Standard Size Balise

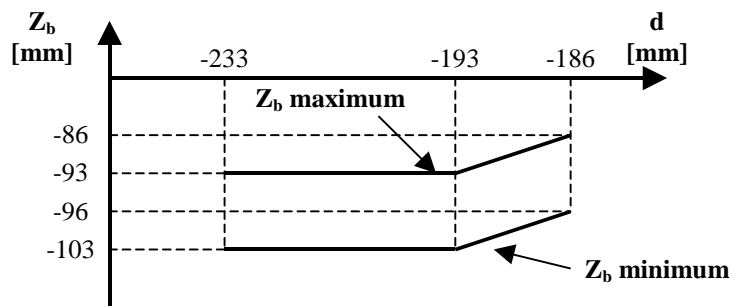
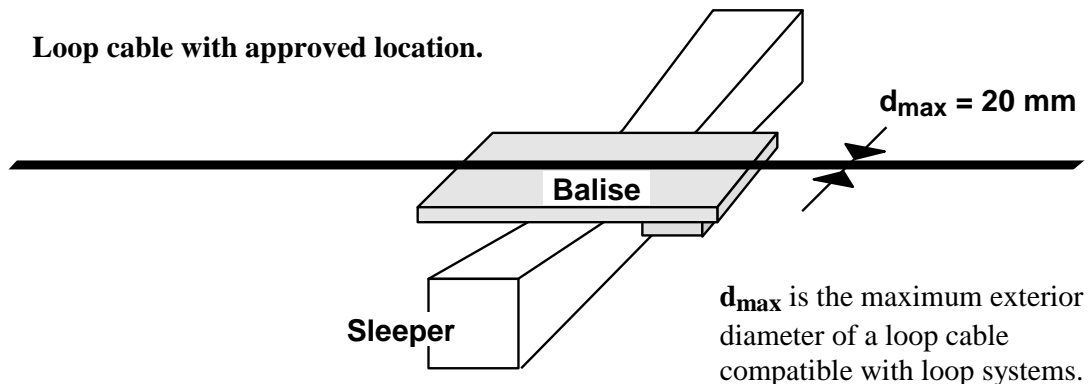


Figure 38: Mounting height, Reduced Size Balise

## 5.7.10.7 Interfering Conductive Cables

### 5.7.10.7.1 LZB Cables

To ensure cross-talk protection there are restrictions in the way cables can be placed in the proximity of the Balise. The surface above the Balise shall be free from cables and metal material other than those approved. Figure 39 shows the approved mounting of a conductive loop cable on top of and along the X-axis of the Balise. The conductive loop cable may be positioned either on top of the Balise, or underneath the Balise.



**Figure 39: Location of a conductive loop cable**

The company specific Balise installation rules (i.e., installation tolerances and the related fastening devices for the conductive loop cable) shall ensure that the maximum Up-link induction into the conductive loop cable is limited to 0.3 mA (see sub-clause 6.6.10 on page 128). The centre of the conductive loop cable shall always be positioned more than 75 mm below the top of rail during coexistence with Eurobalise.<sup>43</sup>

The acceptance criteria are company specific, and shall consider the company specific installation rules. The test limit (0.3 mA), under the responsibility of the Balise manufacturer, shall consider installation rules, source and load impedance, matching conditions, type of soil, metallic bridges, metallic structures, and cable crossings (phenomena likely to cause resonance phenomena). For test purposes, the specific set-up of SUBSET-085 applies.

The company specific Balise installation rules (i.e., installation tolerances, the related fastening devices for the conductive loop cable, and in some exceptional cases recommended suitable ferrite devices) shall also ensure that the maximum allowed Tele-powering induction into the conductive loop cable does not generate a malfunction of the Balise (e.g., an erroneous start-up behaviour and/or a continuously activated Balise).

<sup>43</sup> In rare circumstances (e.g., unfavourable combinations of the length of the conductive loop cable related to the wave propagation properties), full intrinsic cross-talk protection can not be guaranteed on a single Balise level. However, additional protection is ensured on system level (such as Balise Groups with multiple Balises, linking, etc.).

It is assumed that the maximum allowed induction generated by the On-board Transmission Equipment, induced into conductive loop cables, is limited and defined according to sub-clause 6.6.10 on page 128<sup>44</sup>. The current into real conductive loop cables might be different, and may fluctuate along the conductive loop cable due to electromagnetic coupling with the surroundings of the cable.

When installing Balises, it shall be guaranteed that the current level defined below is not exceeded above the Balise. The solution is that suitable ferrite devices are applied on the LZB cable (at least one ferrite on each side of the Balise) in some exceptional cases for the purpose of reducing the 27 MHz current. Key parameters for the suitable devices are found in Annex C (clause C2 on page 140). In installations where the centre of the LZB cable is always positioned more than 105 mm below the top of the rail, ferrite devices should not be used. In installations where the centre of the LZB cable is anywhere along the cable segment positioned within the interval 75 mm to 105 mm below the top of rail, and/or longitudinal mounting of Reduced Size Balises applies, ferrite devices with properties as defined in clause C2 on page 140 shall be applied. It is assumed that the LZB cable is never installed higher than 75 mm below the top of the rail (during coexistence with Eurobalises).

The acceptance criteria for the purpose of 27 MHz testing of Balises, shall consider the company specific installation rules. The test limit shall consider the same aspects as for Up-link induction above, and shall be 250 mA.

For test purposes, the specific set-up of SUBSET-085 applies. Please observe that during laboratory testing, using the set-up of SUBSET-085 and the limit above, no ferrite devices shall be applied.

The acceptance criteria for Balise testing may be limited to checking that the Balise does not start generating any Up-link signal (defined as no Up-link signal exceeding  $I_{u1} - 10$  dB), and that it shows correct start-up behaviour when subjected to a typical dynamic Tele-powering ramp (CW and toggling).

The company specific installation rules shall consider the fluctuation of the resultant current along the conductive loop cable due to electromagnetic coupling to the surroundings of the conductive loop cable (e.g., reflections, standing waves, etc.).

The above requirements related to the Balise in the presence of LZB cables only apply to products intended for this use.

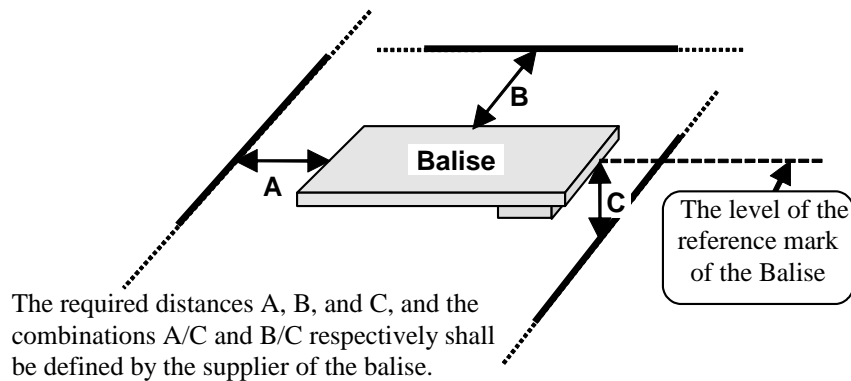
---

<sup>44</sup> The values of sub-clause 6.6.10 on page 138 are assumed under the condition of minimum serial loop impedance of 75  $\Omega$  for the installed LZB cable.



### 5.7.10.7.2 Other Cables

The Balise shall be installed in such a way that the interaction with other cables is low. The Balise shall be far enough from a cable to guarantee that the interaction with the cable is kept below the levels defined in the following.



**Figure 40: Location of other cables**

When defining the distances A, B, and C, the metal free volume in sub-clause 5.7.10.1 on page 94 shall be respected.

The Balise shall be installed in such a way that the induction from the Up-link signal to any nearby cable causes a current:

- Less than 2 mA in the Up-link frequency band when the cable passes the same track at another position, or passes another track. At those passing positions, the applicable vertical distance is equal to or exceeds 93 mm below the top of the rail in this case.
- Less than 10 mA in the Up-link frequency band when the cable passes the same track at another position, or passes another track. At those passing positions, the applicable vertical distance is equal to or exceeds 493 mm below the top of the rail in this case.

These values consider the maximum Up-link current possible for the specific Balise under consideration.

The Balise shall be installed in such a way that a current of a certain maximum value being induced in a nearby cable from a Tele-powering signal does not generate a malfunction of the Balise (e.g., input-to-output characteristic).

It is assumed that the maximum allowed induction generated by the On-board Transmission Equipment, induced into cables at a position underneath the Antenna Unit, is limited and defined according to sub-clause 6.6.10 on page 128. The current into real cables might be different, and may fluctuate along the cable due to electromagnetic coupling with the surroundings of the cable.

The company specific installation rules shall handle the current arising in the vicinity of the Balise (Up-link and Tele-powering) by rules that limit the influence to the Balise so that the requirements above are fulfilled (no cross-talk or no malfunction respectively).

For the case of cables equal to or more than 93 mm below top of rail, it can be assumed that the requirements are fulfilled if a cable is more than two meters away from the Balise. In the same way, the distance one metre is assumed sufficient for the 493 mm case. This applies to both Up-link and Tele-powering, and assuming normal conditions.

The installation rules shall consider the fluctuation of the resultant current along the cable due to electromagnetic coupling to the surroundings of the cable (e.g., reflections, standing waves, etc.).

For the Interface 'C' cable, all installation rules shall be defined by the supplier of the Balise. However, the maximum induced currents specified above shall be respected.

## **5.8 Specific EMC Requirements**

### **5.8.1 In-band Emission**

The Up-link Balise shall comply with EN 302 608.

### **5.8.2 Out-band Emission**

The Up-link Balise shall comply with EN 302 608.

### **5.8.3 Susceptibility Requirements**

The Up-link Balise shall comply with the applicable items of table 1 and table 2 in sub-clause 6.2 of EN 50121-4. This requirement does neither apply for the in-band frequency band  $4.234 \text{ MHz} \pm 1 \text{ MHz}$ , nor for the frequency range  $\pm 500 \text{ kHz}$  centred on the Tele-powering carrier frequency.

## **5.9 Specific Electrical Requirements**

### **5.9.1 General**

During normal operation, as well as in accidental conditions, the installation of the Balises and the related Balise controlling interface cables shall be provided with suitable means to ensure:

- protection of persons against electric shock hazard (e.g., stepping over the Balise);
- protection of equipment against damage due to over-voltage.

### **5.9.2 Provisions against accidental contact with the traction power voltage**

In accordance with sub-clause 6.2.1 of EN 50122-1, the parts that are located within the “Overhead contact line zone, or pantograph zone” (as defined in sub-clause 3.3.8 of EN 50122-1), shall be protected according to the provisions defined in sub-clauses 6.2.3 and 6.2.4 of EN 50122-1.

### 5.9.3 Insulation co-ordination

For the insulation co-ordination according to EN 50124-1, special attention shall be given to sub-clause 6.1 of EN 50124-1. For the Balise, the following parameters apply:

- Over-voltage category

Over-voltage category OV3 shall be considered for the Balise either in stand-alone use, or connected via the Balise controlling interface cable to the LEU.

- Working voltage

The worst case working voltage shall be determined, considering the Tele-powering originated voltage (as per sub-clause 5.2.2.6 on page 63), induced voltages (as per sub-clause 6.1.3 of EN 50124-1), as well as the auxiliary energy source (as per sub-clause 5.3.3 on page 73).

- Rated impulse voltage

The Rated Impulse Voltage ( $U_{Ni}$ ) shall be determined on the basis of Table A.1 of EN 50124-1.

For Balises, a minimum Rated Impulse Voltage of 4 kV shall be considered between any metallic part in the Balise (e.g., fixing devices, connectors, etc.) directly or indirectly connected to the earth, and the Balise case.

- Pollution degree

For parts that are placed outdoors (the Balise itself, and the Balise controlling interface cable), the pollution degree PD4B shall be considered.

### 5.9.4 Dielectric Tests

Dielectric tests shall be carried out on specimen of stand alone Balises, or on typical arrangements of Balises with the Balise controlling interface cable, in order to verify the fulfilment of the insulation requirements of sub-clause 5.9.3 above. Tests shall be organised and carried out in accordance with Annex B of EN 50124-1.

## 5.10 Requirements for Test Tools and Procedures

See SUBSET-085, which includes a complete set of test specifications, test procedures, and test tools regarding the mandatory tests.

## 5.11 Quality and Safety Assurance

All actions shall comply with the methodology stated in EN 50126, and with the methods stated in EN 50129 and EN 50128 (if applicable).

## 6 On-board Equipment

### 6.1 Architectural Layouts

The On-board Transmission Equipment is part of the ERTMS/ETCS On-board Constituent, and has the main functions to generate Tele-powering signals to the Balise, to receive and process Up-link signals from the Balise, to constitute the interface between the air-gap (Interface 'A') and the ERTMS/ETCS Kernel, and to provide applicable test data to the Test Interfaces via an Interface Adapter.

The On-board Transmission Equipment includes an Antenna Unit, and a functional block denominated the BTM function.

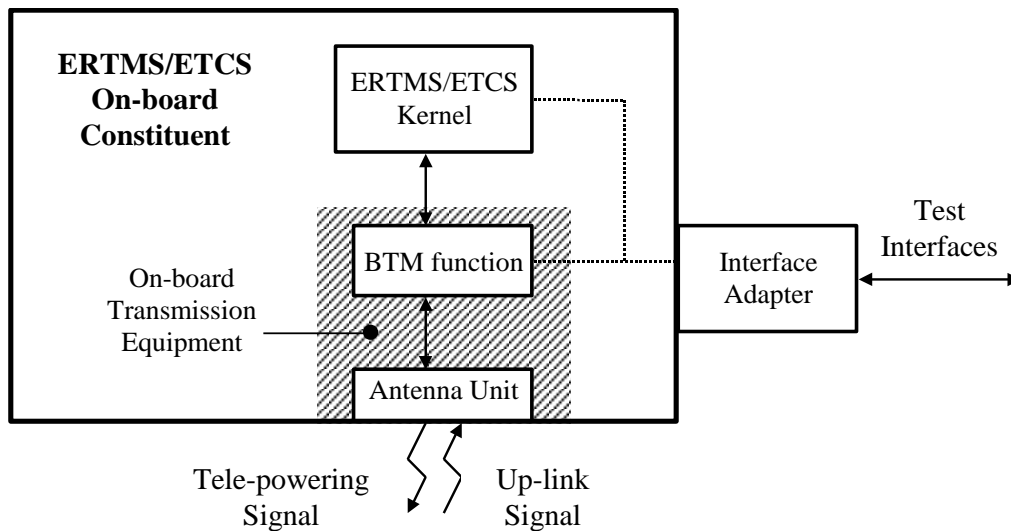


Figure 41: On-board Transmission Equipment and its main interfaces

### 6.2 Antenna Air-gap Interface

#### 6.2.1 Tele-powering Energy Transmission

##### 6.2.1.1 Transmission Medium

The On-board Antenna Unit shall provide power to the wayside Up-link Balises by generating a magnetic field. This field shall be produced in a transmit loop of the Antenna Unit, and induce a voltage in a reception loop of the Up-link Balise. The induced voltage in the Balise shall be based mainly on the vertical component of the magnetic field that flows through the Balise loop.

A Standard Size Up-link Balise and a Reduced Size Up-link Balise exist. The definition of Balise size is related to the size of the reference area that the performance of the Balise is related to. The field distribution from the Antenna Unit shall be such that an Up-link Balise gets enough power to be able to provide an output signal forming the contact volume for the Antenna Unit in question. This also relates to the specific Up-link Balise (Reduced or Standard Size) and the specific conditions.

## 6.2.1.2 Tele-powering Electrical Data

### 6.2.1.2.1 CW Tele-powering signal

The magnetic field shall be produced at a frequency of 27.095 MHz with a tolerance of  $\pm 5$  kHz.

The signal shall be a continuous wave (CW). The carrier noise shall be  $< -110$  dBc/Hz at frequency offsets  $\geq 10$  kHz.

### 6.2.1.2.2 Toggling Modulation

For interoperable systems, the On-board Transmission Equipment shall be able to pulse width modulate the Tele-powering carrier signal by a 50 kHz synchronisation signal according to clause D1 of Annex D on page 141.

Only one kind of modulation may take place at any given time of operation. See sub-clauses 4.2.6 on page 31, and 4.2.7 on page 31.

### 6.2.1.2.3 Intentionally Deleted

## 6.2.1.3 Compatibility Requirements on the Tele-powering signal

The On-board Transmission Equipment shall transmit a 27 MHz CW Tele-powering signal when passing over KVB, Ebicab, or RSDD Balises in order not to be disturbed by these Balises.<sup>45</sup>

In order to achieve compatibility with old types of KER Balises, the maximum flux from the On-board Transmission Equipment shall be 200 nVs in a Standard Size Reference Area positioned at a vertical distance of 93 mm below the top of rail. Alternatively, the maximum flux level 140 nVs applies in a Standard Size Reference Area positioned at a vertical distance of 150 mm below the top of rail. The respective flux levels refer to a CW Tele-powering flux level where the KER Balises shall not be destroyed or degraded.

For the purpose of testing, the minimum absolute value of the complex impedance of the KER Balise is assumed to be  $40 \Omega$ , measured at a flux level of 3 dB below the respective maximum flux levels (i.e., 140 nVs and 100 nVs respectively).

The heights refer to the vertical position of the Standard Size Reference Area, and during testing the Test Antenna shall be positioned at respectively 220 mm and 277 mm above the KER Balise.

## 6.2.1.4 Antenna Unit and Balise interaction

See sub-clause 5.2.2.3 on page 57.

The On-board Transmission Equipment shall guarantee that, in all possible operational conditions, the magnetic flux concatenated with the Balise reference areas (standard size, reduced size, and reduced size with transversal installation) never exceeds the applicable  $\phi_{d4}$  value (see sub-clause 5.2.2.6 on page 63), in both CW and toggling mode, when the Balise impedance fulfils the requirements of sub-clause 5.2.2.6 on page 63.

---

<sup>45</sup> A KVB, RSDD, or Ebicab Balise might transmit one or two bits (at an ASK modulated data rate of 50 kbit/s) before it turns silent again. This shall not affect the BTM function.

### 6.2.1.5 Tele-powering Field Distribution

The field distribution from the Antenna Unit shall be such that the Balise gets enough power to be able to provide an output signal forming the Contact Volume for the Antenna Unit in question. This also relates to the specific Balise (Reduced Size or Standard Size), and the specific conditions.

The field strength from the Antenna Unit shall be defined as the total flux into a Balise reference area placed in any position relative to the Antenna Unit in accordance with sub-clause 5.2.2.4 on page 58. The total flux through this area can be measured by a calibrated Reference Loop (see sub-clause 5.2.2.4 on page 58). The input signal to the Balise, for different positions relative to the Antenna Unit, is the flux through the Reference Area in accordance with sub-clause 5.2.2.4 on page 58.

The deviation of the field form from the Antenna Unit, due to debris and proximity of conductive material, relative to the field form in free air, shall be considered in the Antenna Unit design (see also sub-clause 5.2.2.5 on page 59).

Debris and the proximity to conductive material may influence the efficiency of the Antenna Unit itself. Such influence shall be within the specified limits for the performance of the Antenna Unit.

The levels of debris, nominated as Class A and Class B layers, are defined herein. The Antenna Unit design shall be such that both Class A and Class B Balises are properly handled.

### 6.2.1.6 Procedure control and Error Handling

Side lobes shall be handled by the BTM function based on the received signals from Interface 'A1', and on the time and odometer information.

The On-board Transmission Equipment shall normally use the lobe where the Antenna Unit and the Balise are aligned to each other (in the case of stopping over a preceding side lobe, the received data may be passed on to the ERTMS/ETCS Kernel after a time-out, see sub-clause 6.2.2.5 on page 113). This lobe is called the main lobe. Outside this lobe, the magnetic flux through the reference area of the Balise changes sign, and a side lobe is generated by the Antenna Unit. If the flux in this side lobe is strong enough to activate the Balise, the Balise may respond with an Up-link signal. The filtering of this Up-link signal shall be made by the BTM function. The activation of the Balise before or after the main lobe shall not disturb the transmission in the main lobe.

The On-board Transmission Equipment shall filter the lobes of data transmission based on the physical properties of the Balise signal, and on the Balise configuration data given by the Balise telegram. The field distribution and the design of the Antenna Unit may generate more than one lobe while passing a Balise. Thus one Balise may be interpreted as two or more Balises. Consequently, even if more than one lobe has been received from one Balise, the BTM function shall report to the ERTMS/ETC Kernel that only one Balise has been passed.

The level of field strength from the Antenna Unit that is needed to activate the Balise in the contact volume required for Balise detection shall be supervised by the On-board Transmission Equipment. If the transmitted level of the Tele-powering signal is so low that Balises may not be detected by the On-board Transmission Equipment, this is an error and shall be detected by the On-board Transmission Equipment. If the level of the Tele-powering signal is so high that it may generate cross-talk, this error shall be detected by the On-board Transmission Equipment.

An alternative to the ability of detecting these errors is that the errors are shown to have a low enough probability to occur.

### 6.2.1.7 Metal Masses outside of the specified Metal Mask

In general, there could be metallic objects in the track that might obstruct the ability of the On-board Transmission Equipment to check that it can detect a Balise. However, objects complying with the criteria in sub-clause 6.5.2 on page 123 shall not impact the On-board Transmission Equipment from this perspective. This is further dealt with in sub-clause 6.2.1.8.

While passing a metal mass that is outside the specified metal mask <sup>46</sup> according to Table 18 on page 123, the On-board Transmission Equipment shall be allowed to give an alarm to the ERTMS/ETCS Kernel. The ERTMS/ETCS Kernel shall ignore this alarm by having been informed in advance, e.g., by the appropriate Balise information.

The metal mass is considered outside the allowed mask if:

- Being positioned higher than specified in Table 18.
- Having a larger width than specified in Table 18, and the object is positioned in the range between the specified maximum height and 50 mm below the specified maximum height.
- Having a length exceeding 10 m, and being positioned in the range between the specified maximum height and 50 mm below the specified maximum height.

The distance from the end of such a metal mass to the centre of a Balise shall exceed <sup>47</sup>:

$$d_b \text{ [m]} \geq 0.2 \text{ [s]} \cdot \text{Maximum Permitted Speed [km/h]} / 3.6$$

Other metallic objects important for the air-gap transmission (but not having impact on obstructing the ability of the On-board Transmission Equipment to check that it can detect a Balise) are defined in sub-clause 5.7.10 on page 94.

### 6.2.1.8 Metal Masses and Distances to Balises

In the presence of metallic objects according to category 1 of sub-clause 6.5.2 on page 123, the distance  $d_{object}$  in longitudinal direction from this metallic object to the centre of a nearby Balise shall be according to the following equation <sup>48</sup>, where the length of the metallic object is  $l_{object}$ :

$$d_{object} \geq 0.35 \cdot \sqrt{l_{object}} + 1.1 \text{ [m]}$$

For metallic objects according to category 2 of sub-clause 6.5.2 on page 123, the distance  $d_{object}$  in longitudinal direction from this metallic object to the centre of a nearby Balise shall be according to the following equation.

$$d_{object} \geq 1.1 \text{ m}$$

For metallic objects according to category 3 of sub-clause 6.5.2 on page 123, the normal Balise installation requirements according to sub-clause 5.7.10.1 on page 94 apply.

---

<sup>46</sup> For example a metal bridge.

<sup>47</sup> It shall be allowed for the On-board Transmission Equipment to use 200 ms to recover its normal function, the ability to detect and read Balises, when the influence from the metal mass has disappeared.

<sup>48</sup> The equation is considering the maximum acceleration of the train.

## 6.2.2 Up-link Data Reception

### 6.2.2.1 Up-link Balise Detection

The On-board Transmission Equipment shall ensure that it is able to detect Balises in accordance with sub-clause 6.4.5 on page 116. The only exception shall be when there is full safety protection by other means on system level. One example is related to situations where large metallic objects are being passed (see sub-clause 6.2.1.7 on page 111).

It is a requirement that there is a threshold within the BTM function that is based on a voltage representing the received field strength. The actual implementation is supplier dependent. It shall be possible to verify this threshold (hereafter referred to as  $V_{th}$ ) using a certain current encircling the borders of the specified reference area positioned in a defined geometrical position. It is not a requirement that the actual threshold voltage level is available (but the function is subject to verification).

The BTM function shall not deliver any received telegram to ERTMS/ETCS Kernel when the received field strength is lower than a threshold value of  $V_{th}$ .  $V_{th}$  shall be set to correspond to a field that is generated by the current  $I_{uth}$  encircling the borders of the specified reference area in the geometrical worst case position. The value of the field strength that corresponds to the current  $I_{uth}$  depends on the size and orientation of the specified reference areas (two different sizes with two different orientations for the smaller size reference area are possible), and on the design of the Antenna Unit.<sup>49</sup> The level is fundamental for the cross-talk protection and the detection of the Balise.

The BTM function shall detect a Balise when the field strength from the Balise is higher than  $V_{th}$  during a minimum time  $T_{DET}$ .  $T_{DET}$  may vary with the speed and it depends on the design of the Antenna Unit.

### 6.2.2.2 Telegram Reception

The BTM function shall be able to receive a telegram from a Balise in the Contact Volume.

The distance in the X direction above the Balise where reliable transmission shall take place shall be longer than the minimum required contact length, in which the coding requirements and the dynamic start-up times for the Balise and the On-board Transmission Equipment are taken into account.

The contact length  $S$  shall be:

$$S > V \cdot (R \cdot T_{BL} + T_{BAL} + T_{BTM} + T_{REL}) \quad (\text{see footnote } ^{50})$$

- $V$  = The maximum specified speed for the combination of Antenna Unit, Balise, and telegram length.
- $R$  = A factor for safe reception of a telegram. It will correspond to a number of extra bits, which is defined by the coding requirements.
- $T_{BL}$  = The transmission time for the longer and the shorter telegram respectively.
- $T_{BAL}$  = The start-up time for the Balise.
- $T_{BTM}$  = The start up time for the BTM function and Antenna Unit together.
- $T_{REL}$  = Extra time that is needed to have the required reliable transmission.<sup>51</sup>

For the On-board receiver, both the MTIE requirements of Figure 9 on page 55 and Figure 10 on page 55 apply.

<sup>49</sup> This means three values of  $I_{uth}$  for each type of Antenna Unit.

<sup>50</sup> The terms  $R$ ,  $T_{BTM}$ , and  $T_{REL}$  shall be defined by the manufacturer of the equipment.

<sup>51</sup> The time  $T_{REL}$  shall be considered and set by the user of the system, taking into account the desired availability of the system with respect to the expected level of external noise that may disturb the transmission.



### 6.2.2.3 Decoding Requirements

See sub-clause 4.3 on page 36.

### 6.2.2.4 Reporting

After the Balise passage, both data and reference position shall be made available to the ERTMS/ETCS Kernel. Different telegrams, possibly received during a telegram switching, are not normally required to be reported. If more than one valid telegram is received by the On-board Transmission Equipment from a single Balise (due to telegram switching), then only one telegram with the appropriate location information should be reported to the ERTMS/ETCS Kernel. The choice of the reported telegram is free.

In general, the BTM function shall report Balise detection to the ERTMS/ETCS Kernel when a Balise is detected but no telegram is decoded. In particular, a continuous transmission of only logical '0' or '1' shall be reported in the same way.

### 6.2.2.5 Reporting at low speed (Informative Only)

In case of Balise passage at low speed, more telegrams (due to telegram switching) may be reported for the same Balise.

Under circumstances where the Balise is not passed within the reporting period from the start of the transmission, then the BTM function should make preliminary location reference information and data available to the ERTMS/ETCS Kernel after a time-out of the reporting period after the start of transmission.<sup>52</sup> The location reference information should be made available each reporting period as long as the Balise has not been passed. In the event that the functionality is not implemented for operational purposes, it could exist for the purpose of test and verification.

The reporting period could be between 50 ms and 600 ms.

---

<sup>52</sup> Under circumstances when the vehicle has stopped, for example with the Antenna Unit over the first side lobe of the Balise, then the preliminary location reference may be made available to the ERTMS/ETCS Kernel after a time-out of the reporting period, and it may be based on the side lobe information.

### 6.2.2.6 Cross-talk Conditions

Cross-talk protection is based on the following properties regarding the Antenna Unit and its accompanied installation rules:

- Company specific geometrical conditions for the Antenna Unit (height, and lateral and angular displacements in free air).
- Company specific maximum transmitted levels of field strength.
- Company specific minimum receiving threshold.
- Maximum input-to-output characteristics specified for the Balise.
- Maximum conformity deviation for Up-link in the cross-talk zone of the Balise.
- The assumption that the deviation of the conformity for Tele-powering in the cross-talk zone (for the purpose of cross-talk protection demonstration) is respecting the B value as specified in the side-lobe zone (see sub-clause 5.2.2.5 on page 59).
- The assumption that the provisions specified in sub-clause 5.7.10.4 on page 97 regarding Guard Rail are sufficient to avoid any influence related to cross-talk.
- The influence of cables in the track under all conditions is limited according to sub-clause 6.6.10 on page 128.
- The fulfilment of the company specific installation rules.

The worst case condition when two Antenna Units are involved is that the output signal level of the Balise equals the horizontal line  $I_{u3}$  (independent of the Antenna output field strength of the Antenna Unit that has the Balise in its cross-talk protected zone). In free air propagation, the conformity tolerance B in Figure 14 on page 60 and Figure 15 on page 61 shall be considered for the Balise for Up-link in the Balise cross-talk zone.

## 6.3 Intentionally Deleted

## 6.4 RAMS Requirements

### 6.4.1 On-board Transmission Equipment functionality

Table 16 below defines the functionality of the On-board Transmission Equipment, together with a linking to the top-level functionality of sub-clause 4.4.2 on page 42 and top-level hazards of sub-clause 4.4.6.3 on page 46.<sup>53</sup> Optional functions and barriers defined in sub-clause 4.1.4 on page 24 are intentionally excluded.

On-board functionality:	Related top-level functions	Related top-level hazards
Generation of correct Tele-powering signal	F1, F2	H1, H3, H5, and H6 apply
Detection of Up-link Balises	F1	H1, H2, and H3 apply
Up-link signal filtering and demodulation	F1, F2	H1, H3, H4, H5, and H6 apply
Physical Cross-talk protection	F1, F2, F3, F4	H2, H7, H8, and H9 apply
Physical prevention of transmission of Side lobes, and/or management of Side lobe effects in data and in location	F2, F3, F4	H5, H7 and H8 apply
Immunity to environmental noise	F1, F2	H1, H2, H4, H5, and H6 apply
Checking of Up-link incoming data with respect to Coding Requirements	F2	H4, H5, and H6 apply
Detection of telegram type and decoding	F2	H4, H5, and H6 apply
Extraction of user data	F2	H4, H5, and H6 apply
Telegram Filtering	F2	H4, H5, and H6 apply <sup>54</sup>
Management of Up-link telegram switching within a Balise passage	F2	H4, H5, and H6 apply
Time and odometer stamping of output data	F3, F4	H7 and H8 apply
Support for Balise Localisation (for vital and non-vital purposes)	F3, F4	H7 and H8 apply
Detection of Bit Errors	F2	H4, H5, and H6 apply

**Table 16: On-board Transmission Equipment functionality and related top-level hazards**

The hazards H2, H3, H5, and H6 are not explicitly quantified for reasons mentioned in sub-clause 4.4.6.3 on page 46. For hazard H4, see also the concept of the non-trusted channel in sub-clause 4.4.6.4 on page 47.

<sup>53</sup> Only the defined functionality is mandatory, but not a specific structure or design solution.

<sup>54</sup> For example, a decision based on longer duration of sufficient quality will reduce the probability of H4.

## 6.4.2 Reliability

See sub-clause 4.4.3 on page 42.

## 6.4.3 Availability

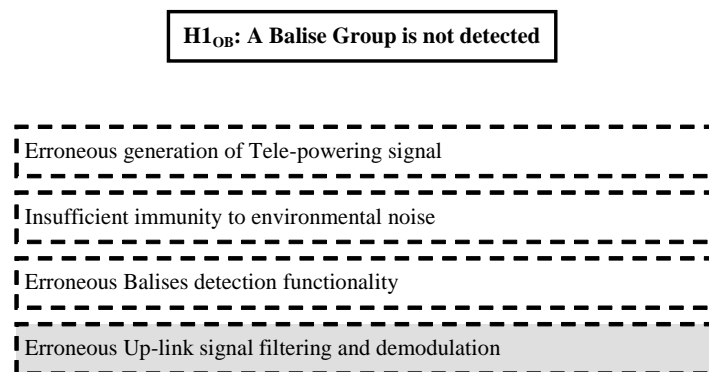
See sub-clause 4.4.4 on page 43.

## 6.4.4 Intentionally Deleted

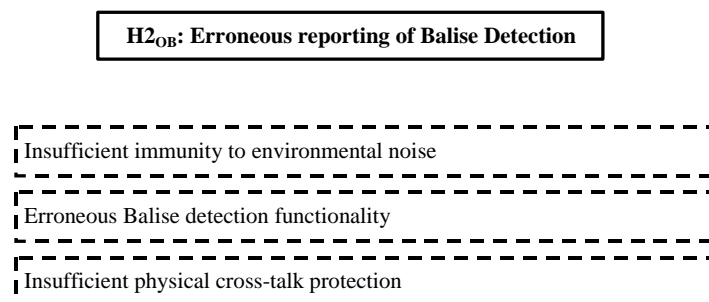
## 6.4.5 Safety

### 6.4.5.1 Hazards and Failure Trees

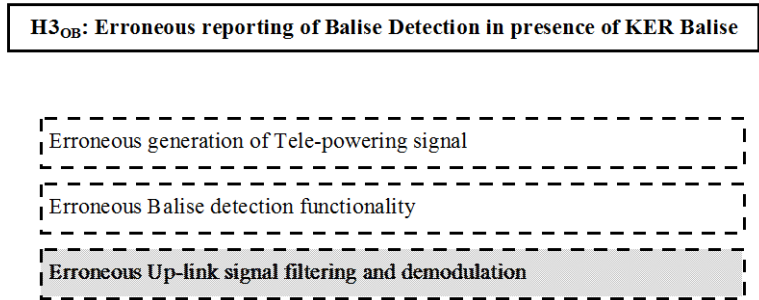
The top-level hazards defined in sub-clause 4.4.6.3 on page 46, and the related Balise functionality of Table 16 in sub-clause 6.4.1 on page 115, are apportioned and broken down as follows. How each failure contributes to the respective hazards  $HX_{OB}$  is company specific, and dependent on implementation of suitable barriers. However, the quantification of sub-clause 6.4.5.2 on page 120 shall be fulfilled. Shaded boxes below include functionality belonging to the platform, which are not included in the quantification of sub-clause 6.4.5.2.



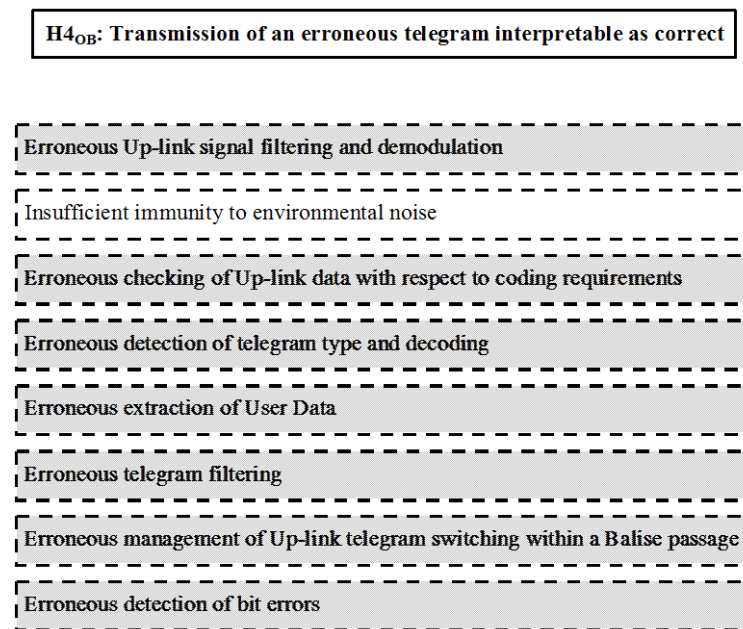
**Figure 42: Balise Group Detection**



**Figure 43: Erroneous Reporting of Balise Detection**

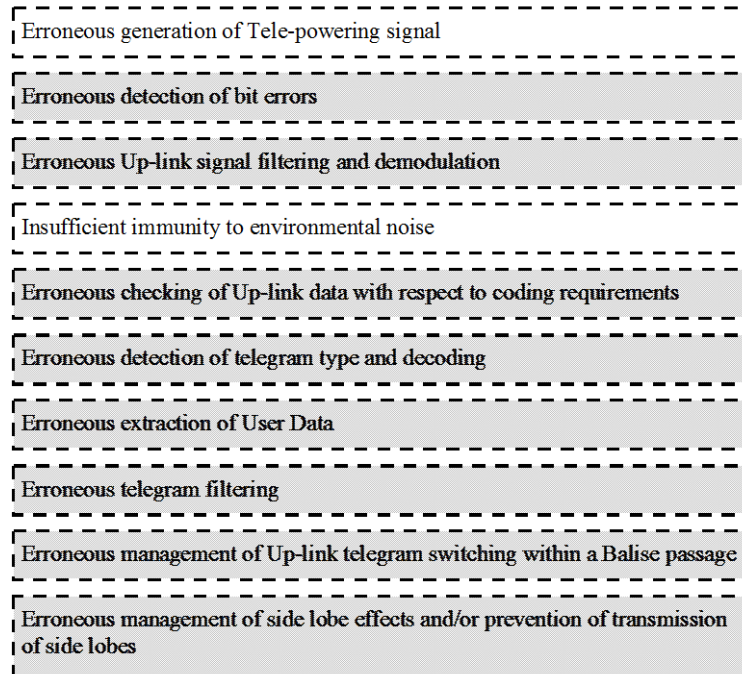


**Figure 44: Erroneous Reporting of Balise Detection in presence of KER Balise**



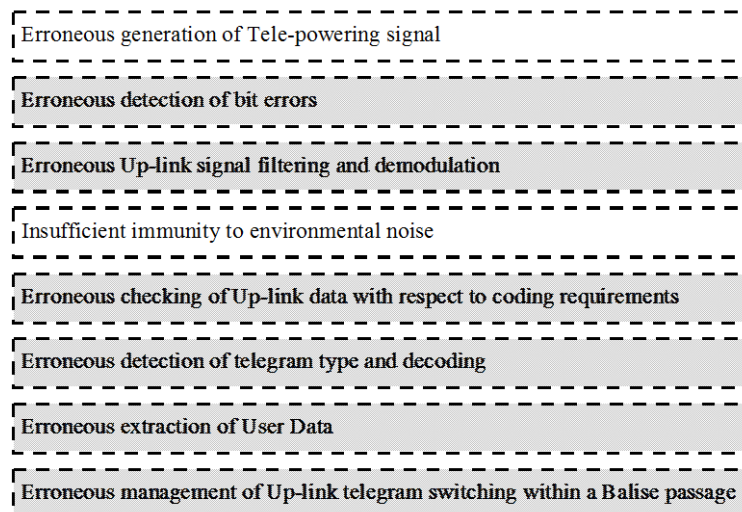
**Figure 45: Erroneous telegram interpretable as correct**

**H5<sub>OB</sub>: Loss of telegram intended for full performance**



**Figure 46: Loss of telegram for full performance**

**H6<sub>OB</sub>: No transmission of default telegram in case of wayside failures**



**Figure 47: No transmission of Default Telegram**

**H7<sub>OB</sub>: Erroneous Balise localisation**

Insufficient physical cross-talk protection

Erroneous management of side lobe effects and/or prevention of transmission of side lobes

Erroneous time and odometer stamping of output data

Erroneous support for Balise localisation

**Figure 48: Erroneous Localisation**

**H8<sub>OB</sub>: The order of reported Balises is erroneous**

Insufficient physical cross-talk protection

Erroneous management of side lobe effects and/or prevention of transmission of side lobes

Erroneous time and odometer stamping of output data

Erroneous support for Balise localisation

**Figure 49: Order of reported Balises is erroneous**

**H9<sub>OB</sub>: Erroneous reporting of Balises in a different track**

Insufficient physical cross-talk protection

**Figure 50: Reporting of Balises in a different track**

### 6.4.5.2 Quantification

Table 17 defines the requirements that shall be fulfilled for the On-board Transmission Equipment hazards of sub-clause 6.4.5.1 on page 116, when assuming that the specified maintenance is fulfilled.

No.	Hazard Description	$\lambda$ [f/h]
H1 <sub>OB</sub>	A Balise Group is not detected <sup>55</sup>	SUBSET-091, ETCS_OB07 denominated Failure of Balise Group Detection.
H2 <sub>OB</sub>	The On-board Transmission Equipment erroneously reports that it has detected a Balise	-
H3 <sub>OB</sub>	The On-board Transmission Equipment erroneously reports detection of a Eurobalise in presence of a KER Balise	-
H4 <sub>OB</sub>	Transmission of an erroneous telegram interpretable as correct	SUBSET-091, ETCS_OB06 denominated Corruption of Balise Message.
H5 <sub>OB</sub>	Loss of the telegram, from a certain Balise, intended for full performance	-
H6 <sub>OB</sub>	No transmission of Default Telegram in case of wayside failures	-
H7 <sub>OB</sub>	Erroneous localisation of a Balise with reception of valid telegram	See requirements for O1 and O2 below, and further explanations in Annex F.
H8 <sub>OB</sub>	The order of reported Balises, with reception of valid telegram, is erroneous	See requirements for O1 and O2 below, and further explanations in Annex F.
H9 <sub>OB</sub>	Erroneous reporting of a Balise in a different track, with reception of valid telegram	See requirements for O1 and O2 below, and further explanations in Annex F.

**Table 17: Quantification for On-board Transmission Equipment**

From the overall requirements in UNISIG SUBSET-091 and the methodology of Annex F, the following mandatory requirements on unavailability apply:

- $O1 \leq 10^{-6}$
- $O2 \leq 10^{-6}$

O1 means that the On-board equipment is more sensitive than expected. It is assumed that it can not be more than 30 dB sensitive than a fault free equipment.

O2 means that the On-board equipment is transmitting more Tele-powering field than specified. It is assumed that it can not transmit more than 10 dB higher field than specified (i.e., not more than  $\phi_{d4} + 10$  dB).

The hazards H7<sub>OB</sub>, H8<sub>OB</sub>, and H9<sub>OB</sub> are caused by failures in the threshold function of the On-board Transmission Equipment and/or significantly excessive Tele-powering signal.

<sup>55</sup> A Balise group, which contains information that if it is missed could lead to a hazardous consequence, shall consist of a minimum of two Balises. See ETCS\_TR07 in SUBSET-091.



The quantification of Hazard H4<sub>OB</sub> does not include the non-trusted channel (see sub-clause 4.4.6.4 on page 47).

The figures might originate from a hardware failure, and is thus dependent on MTTR (including the detection time) and the actual failure frequency. The combination of these aspects is the sums quantified in Table 17 above.<sup>56</sup>

The hazards H2<sub>OB</sub>, H3<sub>OB</sub>, H5<sub>OB</sub>, and H6<sub>OB</sub> are not explicitly quantified for reasons mentioned in sub-clause 4.4.6.3 on page 46.

### 6.4.5.3 Independence of hazard causes

For some of the hazards, dependencies also have to be considered when calculating the figures of Table 17 on page 120.

Crosswise unavailability of each type of hazard is independent between the On-board Transmission Equipment and the Balise.

Effects of faults shall be analysed in the presence of noise from the air-gap. If the actual worst case noise situation is known, then the faults shall be analysed against this known noise effect, otherwise if the effect is unknown then any ratio of random decoded bit error rate shall be analysed.

### 6.4.5.4 Conditions/Assumptions

The apportionment of the figures of Table 17 on page 120 is based on the following presumptions:

- The Mean Time to Restore (MTTR) is irrelevant for the purpose of the quantification included in sub-clause 6.4.5.2 on page 120 (a faulty On-board Transmission Equipment results in the vehicle being taken out of operation).
- The mean time for detection of On-board Transmission Equipment failures is company specific, and might differ between the various hazards of sub-clause 6.4.5.2 on page 120. The Mission Profile defined in higher system level documentation shall be considered in the company specific choices.
- The dependencies with air-gap related aspects shall be considered. See sub-clause 4.4.6.5 on page 48.
- H5<sub>OB</sub> and H6<sub>OB</sub> means that a physical Balise is either detected or undetected, and that the telegram in question is corrupted and/or not transmitted (i.e., H5<sub>OB</sub> and H6<sub>OB</sub> are always more probable than H1<sub>OB</sub>).
- H6<sub>OB</sub> is assumed to be identical to H5<sub>OB</sub> from an On-board Transmission Equipment standpoint (the On-board Transmission Equipment is transparent from a telegram contents standpoint).
- H8<sub>OB</sub> and H9<sub>OB</sub> are implicitly also included in the case that the Balise is erroneously located (i.e., the figures H8<sub>OB</sub> and H9<sub>OB</sub> are always lower than the figure H7<sub>OB</sub>).
- Erroneous localisation in H7<sub>OB</sub> means that the requirements of sub-clause 4.2.10.2 on page 35 are not fulfilled.
- Only random aspects are included.

---

<sup>56</sup> In which relation those hazards are related to safety is determined by hazard analyses on higher system level.

- The Basic Receiver defined in sub-clause 4.3.4 on page 41 is assumed to be implemented. In case of other receiver principles, the entire analysis included herein needs to be re-considered.
- The On-board Transmission Equipment functionality is an integrated part of the ERTMS/ETCS Constituent. The quantified hazards for the On-board Transmission Equipment (Table 17 on page 120) include potential contribution from dependencies with other On-board functions. For example, assume that in a specific design of an On-board Transmission Equipment the BTM functionality is dependent on information from other functional blocks within the ERTMS/ETCS Constituent (that generates e.g., odometer data or time information), then the specified value of Table 17 includes the effect of this dependency.
- All figures are based on mean detection times. The analyses should be supported by sensitivity analyses wherever deemed necessary.

The following aspects are not within the scope of the quantification of Table 17 on page 120:

- Vandalism
- Exceptional occurrences (e.g., exceptional environmental conditions outside specification)
- Erroneous installation
- Erroneous maintenance
- Occupational Health
- Mechanical damage due to maintenance (causing conditions outside specification)

The quantification should, as far as possible, be based on data acquired by experience. If such data is not available, data from MIL-HDBK 217 or other similar recognised database should be used. Data may be tailored considering manufacturer experience (if available), but explicit justifications are required.

## 6.5 Installation Requirements for Antennas

### 6.5.1 Reference Axes

See sub-clause 4.5 on page 50.

### 6.5.2 Metal Masses in the Track

Metal masses in the track may have a disturbing effect on the On-board Transmission Equipment. For example, metal masses may obstruct the ability of the On-board Transmission Equipment to check that it can detect a Balise.

For compatibility reasons the On-board Transmission Equipment shall tolerate the following metal masses (i.e., not issue an alarm), and be able to properly detect a Balise compliantly with the installation rules defined in sub-clause 6.2.1.8 on page 111.

Category 1:

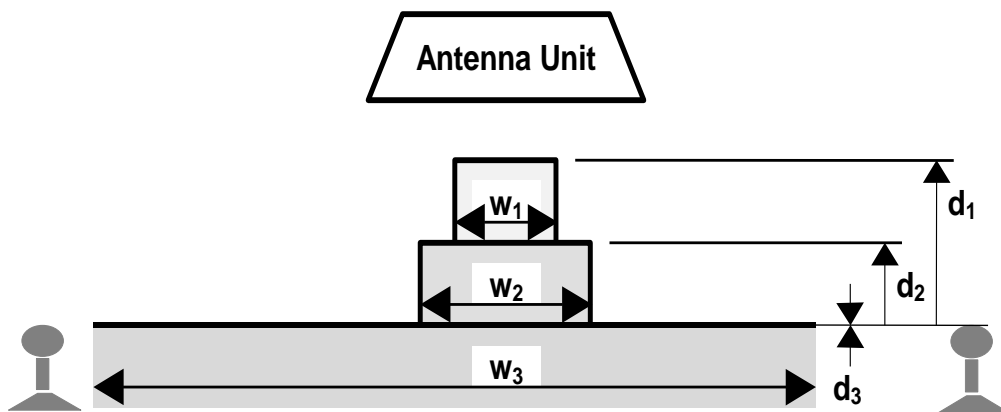


Figure 51: Metal masses in the track

Width	Highest distance from top of rail
$w_1 \leq 120 \text{ mm}$	$d_1 = 92 \text{ mm}$
$w_2 \leq 200 \text{ mm}$	$d_2 = 50 \text{ mm}$
$w_3 > 200 \text{ mm}$	$d_3 = 0 \text{ mm}$

Table 18: Metal masses in the track, Category 1

Within this category 1, the length of the object shall not exceed 10 m. The above defined shapes are considered part of this category if they are positioned in the range between the specified maximum height of Table 18 and 50 mm below the specified maximum height of Table 18.

Category 2:

Width	Highest distance from top of rail
$w_1 \leq 120$ mm	$d_1 = 42$ mm
$w_2 \leq 200$ mm	$d_2 = 0$ mm
$w_3 > 200$ mm	$d_3 = -50$ mm

**Table 19: Metal masses in the track, Category 2**

Within this category 2, there is no restriction on the maximum length of the metallic object. Objects belonging to this category are wider than 100 mm. The above defined shapes are considered part of this category if they are positioned in the range between the specified maximum height of Table 19 and 80 mm below the top of the rail.

Approved installation in the vicinity of guard rails is explicitly dealt with in sub-clause 5.7.10.4 on page 97.

Category 3:

This includes all other cases that form less demanding cases.

In case of potential overlapping between categories, the most restrictive case shall apply.

Other restrictions concerning metal masses in the track shall be handled on a higher system level and are defined in sub-clauses 6.2.1.7 on page 111 and 6.2.1.8 on page 111.

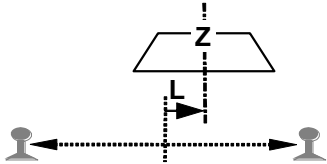
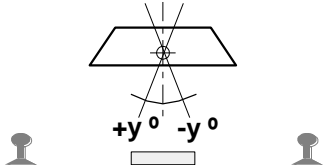
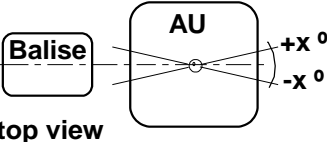
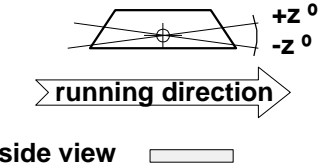
A step by step guideline for determining the relevant category of the object is found in Annex G on page 153.

### 6.5.3 Antenna sizes and Mounting Requirements

Manufacturer dependent.

### 6.5.4 Allowed displacements for the Antenna Unit

The allowed static and dynamic displacements of the Antenna Unit relative to the track should be specified in a table having the following shape. The reference axes and angles are described in sub-clause 4.5 on page 50.

	Dynamic displacement	Static position	Total displacement	
The minimum vertical distance from the reference marks of the Antenna Unit to the top of rails:	ddd mm	sss mm	ttt mm	
The maximum vertical distance from the reference marks of the Antenna Unit to the top of rails:	ddd mm	sss mm	ttt mm	
The total maximum lateral deviation (L) between the Z reference mark of the Antenna Unit and the centre axis <sup>57</sup> of the track:	$\pm$ ddd mm	$\pm$ sss mm	$\pm$ ttt mm	
Maximum tilting of the Antenna Unit:	$\pm y^\circ$	$\pm y^\circ$	$\pm y^\circ$	
Maximum yawing of the Antenna Unit:	$\pm x^\circ$	$\pm x^\circ$	$\pm x^\circ$	
Maximum pitching of the Antenna Unit:	$\pm z^\circ$	$\pm z^\circ$	$\pm z^\circ$	

<sup>57</sup> The centre axis of the track is located half the distance between the web of the rails. The value of the lateral deviation shall include the influence from lateral rail wear.

## **6.6 Specific Environmental Conditions for Antennas**

### **6.6.1 Operational Temperature**

The Antenna Unit shall fulfil one of the classes of the sub-clause 4.3 (Temperature) of EN 50125-1.

### **6.6.2 Storage**

During transit and storage, i.e., within a maximum of two weeks, the Antenna Unit should not be damaged by exposure to ambient temperatures in the following range:

$$T_{\min} = -40 \text{ }^{\circ}\text{C}$$

$$T_{\max} = +85 \text{ }^{\circ}\text{C}$$

The Antenna Unit should be designed to be held in storage for a maximum period of 5 years without any requirements for test and inspection. During such storage, the ambient temperature should not exceed the following range.

$$T_{\min} = +15 \text{ }^{\circ}\text{C}$$

$$T_{\max} = +35 \text{ }^{\circ}\text{C}$$

### **6.6.3 Sealing, Dust and Moisture**

The Antenna Unit enclosures should be designed as to allow correct operation at minimum at the IP65 environmental rating as defined in the EN 60529.

The Antenna Unit should be sealed against the effects of moisture, mould growth and contamination.

### **6.6.4 Mechanical Stress**

The Antenna Unit shall fulfil applicable parts of the sub-clause 4.12 (Vibrations and Shocks) of EN 50125-1.

### **6.6.5 Meteorological Conditions**

The Antenna Unit shall fulfil applicable parts of sub-clauses 4.4 (Humidity), 4.5 (Air movement), 4.6 (Rain), 4.7 (Snow and Hail), 4.8 (Ice), and 4.9 (Solar Radiation) of EN 50125-1.

### **6.6.6 Chemical Conditions**

The Antenna Unit shall fulfil applicable parts of sub-clause 4.11 (Pollution) of EN 50125-1.

### **6.6.7 Biological Conditions**

The Antenna Unit shall fulfil applicable parts of sub-clause 4.11 (Pollution) of EN 50125-1.

### 6.6.8 Debris

Table 20 gives examples of debris under the Antenna Unit. The manufacturer shall specify the performance of the Antenna Unit and its maximum allowed debris.

Material	Description	Layer below the bottom of the Antenna Unit [mm]	
		Minimum	Maximum
Snow	Fresh, 0 °C	20	top of Balise
	Wet, 20 % water	10	top of Balise
Ice		10	top of Balise
Mud	Without salt water	10	50
	With salt water, 0.5 % NaCl (weight)	-	50
Iron Ore	Hematite (Fe <sub>2</sub> O <sub>3</sub> )	-	5
	Magnetite (Fe <sub>3</sub> O <sub>4</sub> )	-	5
Iron dust	Braking dust	2	5
Coal dust	8 % sulphur	-	5
Oil and Grease		2	20

**Table 20: Examples of debris under the Antenna Unit**

### 6.6.9 Metallic Masses

The Antenna Unit shall be mounted in such a way that metal is avoided in a well-defined area as specified by the manufacturer.

### 6.6.10 Cables

To ensure the proper operation of the Antenna Unit, there are restrictions for cables placed around the Antenna Unit.

The area under the Antenna Unit should be free from cables.

Cables in the area around the Antenna Unit shall be placed at a distance that guarantees that no influence is possible to/from other On-board Transmission Equipment in compliance with the manufacturer installation rules.

The On-board Transmission Equipment shall be able to handle induced currents in cables, in the track underneath the Antenna, from a cross-talk Balise, of:

- Less than 2 mA in the Up-link frequency band when the cable passes the track at a height equal to or lower than 93 mm below the top of the rail.
- Less than 10 mA in the Up-link frequency band when the cable passes the track at a height equal to or lower than 493 mm below the top of the rail.

The above stated current levels are applicable with the return current passing less than 0.5 m underneath the above mentioned cable, simulated by the reference set-up defined in SUBSET-085.

The On-board Transmission Equipment shall limit the induction into suitable test cables, which assume that the return current is passing at 0.5 m below the cable under consideration, so forming a vertical loop underneath the Antenna Unit, and presenting a characteristic impedance of 400  $\Omega$ . The two extremities of the loop shall be closed by the characteristic impedance. This loop shall be checked with longitudinal and transversal orientation with respect to the Antenna Unit. The maximum value of the current at the position of best coupling, and at the minimum company specific height for the Antenna Unit, shall be according to one of the classes in Table 21 below.

Class	Current
1	< 10 mA
2	< 25 mA

**Table 21: Maximum induced current (excluding conductive loop cable)**

Class 1 is applicable to a mounting condition where cables between the rails are positioned at a height equal to or lower than 493 mm below the top of the rail. Class 2 is applicable when cables between the rails are positioned at a height equal to or lower than 93 mm below the top of the rail.

In particular, regarding interaction with the conductive loop cable defined in sub-clause 5.7.10.7.1 on page 103, the following apply.

The On-board Transmission Equipment shall be able to handle induced Up-link currents in the loop cable, from a Balise, not exceeding 0.3 mA. The centre of the LZB cable is always positioned more than 75 mm below the top of rail during co-existence with Eurobalise.

The above stated current level is applicable using the reference set-up defined in SUBSET-085 (defining an impedance level of 75  $\Omega$  and a vertically oriented loop emulating the real LZB cable).



The On-board Transmission Equipment shall also limit the Tele-powering induction into the reference set-up defined in SUBSET-085. The maximum value of the current at the position of best coupling, and at the minimum company specific height for the Antenna Unit, shall not exceed:

- 250 mA in installations where the centre of the LZB cable is always positioned more than 105 mm below the top of the rail.
- 400 mA in installations where the centre of the LZB cable is anywhere along the track positioned within the interval 75 mm to 105 mm below the top of rail.

The LZB cable shall not be installed higher than 75 mm below the top of the rail when coexistence with Eurobalise is required.

For the purpose of testing, the configuration and test tool defined in SUBSET-085 apply.

It is assumed that existing On-board KER systems do not induce currents exceeding the current levels specified herein.

It is assumed there are only two active On-board systems on a specific loop segment, of which one is intended to read the Balise.

## **6.7 Specific EMC Requirements for Antennas**

### **6.7.1 General**

This considers only aspects related to radiation in the air-gap.

### **6.7.2 In-band Emission**

The in-band emission from the Eurobalise On-board Transmission Equipment, when transmitting CW Tele-powering, shall comply with EN 302 608.

For toggling Tele-powering, the frequency mask of sub-clause D1.3 on page 142 applies.

### **6.7.3 Out-band Emission**

The emission from the Eurobalise On-board Transmission Equipment shall comply with EN 302 608.

#### **6.7.4 Eurobalise Transmission Susceptibility**

The manufacturer shall provide information related to the susceptibility of the on-board equipment, to support its integration in the vehicle. This information should make reference to recognised technical standards.

#### **6.7.5 Out-band Susceptibility**

Radiated immunity requirements shall comply with the applicable items of table 9 in clause 8 of EN 50121-3-2. This requirement does neither apply for the frequency band 2.5 MHz to 6.0 MHz, nor for the frequency range  $\pm 500$  kHz centred on the Tele-powering carrier frequency.

### **6.8 Specific Electrical Requirements**

The On-board Transmission Equipment shall comply with the applicable electrical requirements of EN 50155.

### **6.9 Requirements for Test Tools and Procedures**

See SUBSET-085, which includes a complete set of test specifications, test procedures, and test tools regarding the mandatory tests.

### **6.10 Quality and Safety Assurance**

All actions shall comply with the methodology stated in EN 50126, and with the methods stated in EN 50129 and EN 50128.

## Annex A (Informative), Additional technical information

### A1 Coding background

#### A1.1 Encoding

##### A1.1.1 General

Encoding is done as follows:

1. Choose the 12 scrambling bits.
2. Scramble the data bits (in a way that depends on the scrambling bits).
3. Transform the scrambled data by blocks of 10 bits, thereby expanding each block to an 11-bit word.
4. Check the shaping constraints, as far as possible, on the information bits. If they are not satisfied, go to 1.
5. Choose the 10 extra shaping bits (if all  $2^{10}$  combinations are exhausted, go to 1).
6. Form the check bits.
7. Check the shaping constraints. If the telegram passes, stop. Otherwise, go to 5.

These steps are described in sub-clause 4.3.2 on page 37.

The testing in step 4 is not necessary from a purely logical viewpoint. All the testing could be done in step 7. For efficiency reasons, however, it is preferable to reject candidate telegrams as soon as possible, and to have the “inner loop” 5-6-7 that changes only the extra shaping bits.

The general idea behind the format is as follows. Every telegram is a code word in a cyclic code that provides ample protection against random bit errors and burst errors. The 10-to-11-bit transformation improves the protection against bit slips and insertions and excludes long runs of consecutive zeros or consecutive ones. The testing of the candidate telegrams (steps 4 and 7) excludes telegrams that are potentially vulnerable to bit slips and also excludes long telegrams with bit patterns too “close” to a short telegram. The scrambling makes sure that, for given user data, sufficiently many alternative candidate telegrams can be formed so that one of them eventually passes the final test.

The advantage of this probabilistic encoding scheme, with repeated encoding attempts, is that certain properties that are required for a rigorous safety proof are easy to test for any given candidate telegram but are very difficult to ensure by a deterministic encoding procedure (unless a significant number of information bits is sacrificed). However, it is theoretically possible that certain user data cannot be encoded because the shaping bits are exhausted before any candidate telegram passes all tests. The probability of this is very low (less than  $10^{-100}$  for random data). If it should ever happen, a slight change in the user data (such as, e.g., a decrease of the speed limit by 1 km/h) will suffice to make the data encodable. It should also be pointed out that the number of candidate telegrams that must be generated before one is found acceptable can be quite large. In contrast, the receiver is comparatively simple and fast.

### A1.1.2 Comment to the 10-to-11-Bit Transformation

The transformation serves several purposes. First, it does “run length shaping”. The length of the longest run of consecutive zeros or ones is at most 8. This follows from the fact that none of the following 250 words are valid:

00000xxxxxx, xxxxxx00000, 10000000001,  
11111xxxxxx, xxxxxx11111, 01111111110.

Secondly, since none of the following 20 words are valid, a shift of up to 4 positions between the extra bits (see sub-clauses 4.3.4.2 (page 41), 4.3.4.3 (page 41), 4.3.4.4 (page 42), and sub-clause A1.1.1 of this Annex), and the corresponding first bits within the considered window can be detected by the receiver:

0101010101, 10101010101,  
00100100100, 01001001001, 10010010010,  
11011011011, 10110110110, 01101101101,  
00010001000, 00100010001, 01000100010, 10001000100, 00110011001, 01100110011,  
11101110111, 11011101110, 10111011101, 01110111011, 11001100110, 10011001100.

Thirdly, the alphabet was chosen (by empirical search) to support the Off-Synch-Parsing Condition of sub-clause 4.3.2.5.3 on page 40. In particular, shifting any valid word by one position, to the left or to the right, with an arbitrary “new” bit, is unlikely to produce a valid word. Of all words that can be obtained from shifting a valid word to the left, with an arbitrary new bit, only 316 are valid. Of all right shifts, only 324 words are valid.

Finally, the alphabet is transparent to inversion. Inverting all bits of a valid word results in another valid word.

## A1.2 Decoding

### A1.2.1 Synchronisation

Let  $v = [v_{n-1}, \dots, v_0]$  be a length- $n$  block of the bit stream emitted by the Balise (for the long and short format,  $n=1023$  and  $n=341$ , respectively). The block  $v$  is a cyclically shifted version of the transmitted telegram, as illustrated in Fig. 3. In polynomial notation,  $v(x) = Rx^{s-1}[xs \cdot b(x)]$ , where  $b = [b_{n-1}, \dots, b_0]$  is the transmitted telegram and where the integer  $s$  is the number of bits elapsed since the beginning of the telegram, see Figure 52.

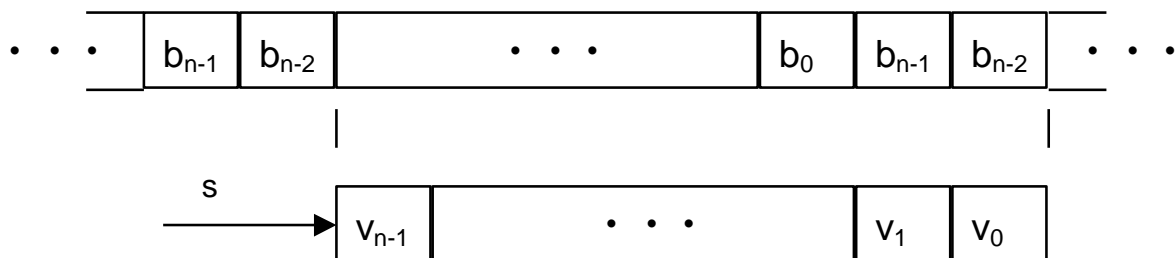


Figure 52: The received data in a length- $n$  window

To determine the value of  $s$ ,  $0 \leq s < n$ , the syndrome  $s_f(x)$  is computed as

$$s_f(x) = R_{f(x)}[v(x)], \quad (\text{A-1})$$

where  $f(x) = f_L(x)$  for the long format and  $f(x) = f_S(x)$  for the short format. It can be shown that

$$s_f(x) = R_{f(x)}[x^s o(x)], \quad (\text{A-2})$$

with  $o(x) = g(x)$  as in sub-clause 4.3.2.4 on page 39. Furthermore, the value of  $s_f(x)$  uniquely determines the value of  $s$  and thus allows synchronisation. Finally, it can be shown (by noting that  $f(x)$  is not a multiple of  $x-1$ ) that

$$R_{f(x)}[v(x) + x^{n-1} + x^{n-2} + \dots + x^2 + x + 1] = R_{f(x)}[v(x)], \quad (\text{A-3})$$

which implies that the synchronisation is transparent with respect to the inversion of all bits.

For an error-free telegram, the value of (A-2) is never 0. However, if  $v(x)$  is any length- $n$  vector that is periodic with a period that divides  $n$  (but is less than  $n$ ), it can be shown that

$$R_{f(x)}[v(x)] = 0. \quad (\text{A-4})$$

In particular, if a long-format receiver is given a repeated short telegram as input, the evaluation of (A-1) always results in  $s_f(x)=0$ .

### **A1.2.2 Comments to the Receiver Operation**

The following comments apply to sub-clause 4.3.4.1 on page 41.

- To 1. The number of extra bits is larger for the short-format receiver to safely exclude long telegrams. The purpose of setting  $r = n$  when 7500 bits have been examined without finding an error-free telegram is to obtain a fixed upper bound, per Balise passage, on the probability of an undetected error (for  $r$  as large as  $n$ , the probability of accepting a corrupted telegram is “zero”). The specific number (7500) is somewhat arbitrary.
- To 2. “Shifting the window” is of course only possible as long as there are additional received bits available. The shifting may be done either by one or several bit positions at a time.
- To 3. Testing the extra bits serves several purposes. For the short format, it guarantees the safe rejection of long telegrams. For both formats, it is essential for the detection of bit slips and insertions.
- To 4. “Impossible” values: For the short format, only 341 (of 1024) values are possible with an error-free telegram. In the long-format receiver, an error-free long telegram cannot produce  $R_{f(x)}[v(x)] = 0$ , but a repeated error-free short telegram always produces  $R_{f(x)}[v(x)] = 0$ .
- To 5. In a practical implementation, it is natural to combine this step with 9. It is essential, however, that all words are tested, not only those in the shaped-data part of the telegram.

It is recommended that each receiver records how often it uses each of the different “go to 1” branches. For example, it is conjectured that such branches other than from step 2 and (for a long-format receiver only) from step 4 occur extremely seldom. Knowing such statistics from the receivers in operation would be valuable for future safety reviews.

## A1.3 Safety Considerations

This is not part of the formal specification. It outlines the deterministic protection that is guaranteed by the basic receiver. Probabilistic aspects are not discussed.

### A1.3.1 Introduction

The telegram format and the basic receiver were designed together with a safety proof for an upper bound of  $10^{-18}$  for the probability, per Balise passage, of accepting a corrupt telegram. The following hazards were considered:

- random bit errors;
- burst errors;
- bit slips and bit insertions, and all combinations thereof;
- potential problems with telegram change and format misinterpretation (long versus short telegrams);
- some further special error modes.

This safety proof is not reproduced here.

What *is* given here is a brief discussion of the “rigid” or “deterministic” error detection capabilities of the basic receiver such as the minimum Hamming distance of the cyclic code or the maximum number of bit slips that are always detected. Note, however, that a rigorous safety analysis cannot be based on such rigid properties alone. For example, the minimum distance is of little help in determining the probability of an undetected error for independent random bit errors that occur with a probability of  $10^{-2}$ .

Apart from the distinction between “rigid” (or “deterministic”) and probabilistic, a number of further distinctions are also important for any safety analysis.

**Engineering approximations versus mathematical proofs.** A simple-minded approach to error detection is to choose some code with  $m$  check bits and hope that the error probability stays below  $2^{-m}$ . A sufficient safety factor is included for cases where this hope is not fulfilled. The problem with this approach is to know how much is “sufficient”. On the other extreme is a rigorous mathematical analysis with explicit upper bounds on the probability of an undetected error for all relevant error models. Unfortunately, the latter approach is not always feasible.

**Uniform versus data-dependent protection.** The protection of a linear code (such as the cyclic code of the present format) against random bit errors and additive burst errors is independent of the user data. All code words enjoy exactly the same protection. On the other hand, the protection by the same code against bit slips depends strongly on the particular code word, with variations from “absolutely safe” to “essentially unprotected”.

**“Random” versus worst-case telegram.** In the average, over all possible telegrams, the protection against bit slips and insertions as provided by  $g(x)$  alone is excellent. This gives little comfort, however, when one of the weak telegrams happens to be the standard message of a Balise outside the central station. Any rigorous safety analysis therefore faces the possibility that the worst-case telegram is in use. Similar worst-case considerations apply also to telegram change (see sub-clause A1.3.4 of this Annex) and format mixing (see sub-clause A1.3.5 of this Annex).

### A1.3.2 Random Bit Errors and Burst Errors

The cyclic codes determined by  $g(x)$  provide excellent protection against random bit errors and (additive) burst errors. The minimum distance of the code for the long format is (at least) 15. That of the short format is (at least) 17. Less errors within the window are always detected by the basic receiver.

Any burst error of length at most 75 bits is also detected by the code. Many combinations of shorter bursts are also guaranteed to be detected. For example, any two bursts of length not exceeding 41 and 24, respectively, are always detected.

### A1.3.3 Bit Slips and Insertions

Any combination of bit slips and insertions with a total of not more than 3 events within the window (length  $n+r$ ) is always detected by the basic receiver (as with random bit errors, most cases with more events are also detected).

### A1.3.4 Telegram Change

We distinguish between two cases, depending on the position of the receiver's length  $n+r$  window. For the purpose of clarity, it is assumed that the transition is marked by (at least) 75 intermediate zeros. The case of intermediate ones is analogous.

- Case 1:** The window starts (or ends) within the transition and contains at most 75 bits from the transition. In this case, at least  $n$  consecutive bits are not affected by the telegram change. On these  $n$  bits, the full protection by the cyclic code applies.
- Case 2:** The window overlaps the transition or contains more than 75 bits from the transition. Consider 75 bits within the transition (in the absence of transmission errors, these 75 bits are either all zeros or all ones). Whatever was received outside the 75 bits determines a unique code word; only *one* 75-bit pattern can thus possibly be accepted by the receiver. If that unique acceptable pattern has less than 13 ones, no error can occur because any such pattern is rejected by step 5 (checking valid words) of the receiver. Therefore, any undetectable error pattern has at least 13 ones within these 75 bits.

### A1.3.5 Format Mixing

**Long telegram and short-format receiver.** The discrimination relies exclusively on testing the 121 extra bits. The Aperiodicity Condition (see sub-clause 4.3.2.5.4 on page 40) gives a Hamming distance of at least 15 if there are no bit slips, and a Hamming distance of at least 4 if there are up to 3 bit slips or insertions.

**Short telegram and long-format receiver.** A repeated short telegram is "almost" a valid long telegram: it satisfies the parity check with respect to the long format (see equation (4) of sub-clause 4.3.2.4 on page 39) as well as the Alphabet Condition, the Off-Synch-Parsing Condition, and the Under-sampling Condition of sub-clause 4.3.2.5 on page 39 (the last of these is actually not needed here). The only two conditions that are not satisfied are the Aperiodicity Condition and the "impossible" synchronisation value  $s_f(x)=0$  (see equation (A-4) of sub-clause A1.2.1 of this Annex), neither of which has any safety role in the long-format receiver. In other words, a repeated short telegram is treated and protected exactly like a long telegram, except that synchronisation fails because of the "impossible" synchronisation value  $s_f(x)=0$ .

### A1.3.6 Over-sampling and Under-sampling

Over-sampling by a factor  $k$  is the process of repeating each bit  $k$  times. Under-sampling was defined in sub-clause 4.3.2.5.5 on page 40. Such events are unlikely to occur during normal operation but might be caused by defect hardware. The reason for considering such error modes is that cyclic codes have a systematic weakness against over-sampling or under-sampling by a power of 2 (because  $a(x^2)=a(x)^2$  for any binary polynomial  $a(x)$ ).

Over-sampling by a factor larger than 8 results in too long runs of zeros and ones that are detected by testing the Alphabet Condition. Over-sampling by an even factor smaller than 8 is covered by the extra bits (which are shifted with respect to the corresponding first  $r$  bits in the telegram).

Under-sampling by a factor of 2, 4, 8, or 16 is covered by the Under-sampling Condition. A large Hamming distance is not required in these cases because the under-sampled pattern is a code word in, and thus protected by, the cyclic code.

## Annex B (Normative), Additional technical requirements

### B1 Requirements on the Tele-powering signal

#### B1.1 Toggling Tele-powering signal

Specification of the toggling Tele-powering signal:

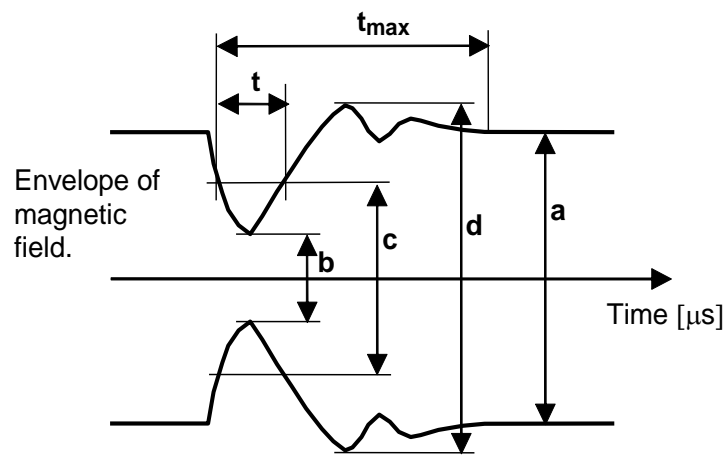


Figure 53: Definition of AM pulse parameters, toggling Tele-powering

- Amplitude modulation shall be at 50 kHz  $\pm$ 200 ppm.
- The off-edge of the signal shall be constant in phase, with less than  $\pm 0.1 \mu\text{s}$  jitter.
- The modulation depth,  $(a-b)/a$ , shall be 100 %,  $+0/-50$  %.
- The pulse width,  $t$ , shall be defined at 50 % of the actual modulation depth,  $c=(a+b)/2$ .
- The pulse width,  $t$ , shall be between 2.0  $\mu\text{s}$  and 3.5  $\mu\text{s}$ .
- Within the defined limits of  $t$ , the pulse width shall alternate between two different values, counted from the off-edge to the on-edge. The difference between the two values of pulse width shall be 1.2  $\mu\text{s}$ ,  $+0.3/-0.4 \mu\text{s}$ .
- The overshoot,  $(d-a)/a$ , shall not exceed 10 %.
- After the time  $t_{max} \leq 7 \mu\text{s}$  the amplitude  $a$  shall not vary more than  $\pm 0.5$  %.

#### B1.2 Non-toggling Tele-powering signal

The definition of the non-toggling Tele-powering signal is found in UNISIG SUBSET-100.

This sub-clause is subject to considerations until the Eurobalise – KER compatibility aspects have been further explored.



---

## B2 The 10-to-11 bit Transformation Substitution Words

The words are listed in octal.

00101, 00102, 00103, 00104, 00105, 00106, 00107, 00110, 00111, 00112,  
00113, 00114, 00115, 00116, 00117, 00120, 00121, 00122, 00123, 00124,  
00125, 00126, 00127, 00130, 00131, 00132, 00133, 00134, 00135, 00141,  
00142, 00143, 00144, 00145, 00146, 00147, 00150, 00151, 00152, 00153,  
00154, 00155, 00156, 00157, 00160, 00161, 00162, 00163, 00164, 00165,  
00166, 00167, 00170, 00171, 00172, 00173, 00174, 00175, 00176, 00201,  
00206, 00211, 00214, 00216, 00217, 00220, 00222, 00223, 00224, 00225,  
00226, 00231, 00233, 00244, 00245, 00246, 00253, 00257, 00260, 00261,  
00272, 00273, 00274, 00275, 00276, 00301, 00303, 00315, 00317, 00320,  
00321, 00332, 00334, 00341, 00342, 00343, 00344, 00346, 00352, 00353,  
00357, 00360, 00374, 00376, 00401, 00403, 00404, 00405, 00406, 00407,  
00410, 00411, 00412, 00413, 00416, 00417, 00420, 00424, 00425, 00426,  
00427, 00432, 00433, 00442, 00443, 00445, 00456, 00457, 00460, 00461,  
00464, 00465, 00470, 00471, 00472, 00474, 00475, 00476, 00501, 00502,  
00503, 00504, 00505, 00506, 00507, 00516, 00517, 00520, 00521, 00522,  
00523, 00524, 00525, 00530, 00531, 00532, 00533, 00534, 00535, 00544,  
00545, 00546, 00547, 00550, 00551, 00552, 00553, 00554, 00555, 00556,  
00557, 00560, 00561, 00562, 00563, 00571, 00573, 00576, 00601, 00602,  
00604, 00605, 00610, 00611, 00612, 00613, 00614, 00615, 00616, 00617,  
00620, 00621, 00622, 00623, 00624, 00625, 00626, 00627, 00630, 00634,  
00635, 00644, 00645, 00646, 00647, 00650, 00651, 00652, 00653, 00654,  
00655, 00656, 00657, 00660, 00661, 00662, 00663, 00666, 00667, 00672,  
00674, 00675, 00676, 00701, 00712, 00713, 00716, 00717, 00720, 00721,  
00722, 00723, 00730, 00731, 00732, 00733, 00734, 00735, 00742, 00743,  
00744, 00745, 00746, 00747, 00750, 00751, 00752, 00753, 00754, 00755,  
00756, 00757, 00760, 00761, 00764, 00765, 00766, 00767, 00772, 00773,  
00776, 01001, 01004, 01005, 01016, 01017, 01020, 01021, 01022, 01023,  
01024, 01025, 01030, 01031, 01032, 01033, 01034, 01035, 01043, 01044,  
01045, 01046, 01047, 01054, 01057, 01060, 01061, 01062, 01075, 01076,  
01101, 01102, 01103, 01110, 01114, 01115, 01116, 01117, 01120, 01121,  
01122, 01123, 01124, 01125, 01126, 01127, 01130, 01131, 01132, 01133,  
01142, 01143, 01144, 01145, 01146, 01147, 01151, 01152, 01153, 01154,  
01155, 01156, 01157, 01160, 01164, 01166, 01167, 01176, 01201, 01214,  
01217, 01220, 01221, 01222, 01223, 01224, 01225, 01226, 01227, 01230,  
01231, 01232, 01233, 01243, 01244, 01245, 01253, 01254, 01255, 01256,  
01257, 01260, 01261, 01272, 01273, 01274, 01275, 01276, 01301, 01302,  
01303, 01305, 01306, 01307, 01317, 01320, 01321, 01332, 01334, 01335,  
01342, 01343, 01344, 01345, 01350, 01351, 01352, 01353, 01355, 01356,  
01357, 01360, 01361, 01364, 01365, 01370, 01371, 01372, 01373, 01374,  
01376, 01401, 01403, 01406, 01407, 01414, 01415, 01416, 01417, 01420,  
01424, 01425, 01431, 01433, 01434, 01435, 01443, 01445, 01456, 01457,  
01460, 01462, 01474, 01475, 01476, 01501, 01502, 01503, 01504, 01505,  
01516, 01517, 01520, 01524, 01532, 01533, 01544, 01546, 01550, 01551,  
01552, 01553, 01554, 01557, 01560, 01561, 01562, 01563, 01566, 01567,  
01576, 01601, 01603, 01604, 01605, 01606, 01607, 01610, 01611, 01612,  
01613, 01614, 01615, 01616, 01617, 01620, 01621, 01622, 01623, 01624,

01625, 01626, 01630, 01631, 01632, 01633, 01635, 01643, 01644, 01645,  
01650, 01651, 01652, 01653, 01654, 01655, 01656, 01657, 01660, 01661,  
01672, 01674, 01675, 01676, 01701, 01720, 01744, 01745, 01746, 01747,  
01750, 01751, 01752, 01753, 01754, 01755, 01756, 01757, 01760, 01761,  
01762, 01763, 01764, 01765, 01766, 01767, 01770, 01771, 01772, 01773,  
01774, 01775, 02002, 02003, 02004, 02005, 02006, 02007, 02010, 02011,  
02012, 02013, 02014, 02015, 02016, 02017, 02020, 02021, 02022, 02023,  
02024, 02025, 02026, 02027, 02030, 02031, 02032, 02033, 02057, 02076,  
02101, 02102, 02103, 02105, 02116, 02117, 02120, 02121, 02122, 02123,  
02124, 02125, 02126, 02127, 02132, 02133, 02134, 02142, 02144, 02145,  
02146, 02147, 02151, 02152, 02153, 02154, 02155, 02156, 02157, 02160,  
02161, 02162, 02163, 02164, 02165, 02166, 02167, 02170, 02171, 02172,  
02173, 02174, 02176, 02201, 02210, 02211, 02214, 02215, 02216, 02217,  
02220, 02223, 02224, 02225, 02226, 02227, 02231, 02233, 02244, 02245,  
02253, 02257, 02260, 02261, 02272, 02273, 02274, 02275, 02276, 02301,  
02302, 02303, 02315, 02317, 02320, 02321, 02332, 02334, 02342, 02343,  
02344, 02346, 02352, 02353, 02357, 02360, 02361, 02362, 02363, 02370,  
02371, 02374, 02376, 02401, 02403, 02404, 02405, 02406, 02407, 02412,  
02413, 02416, 02417, 02420, 02421, 02422, 02424, 02425, 02426, 02427,  
02432, 02433, 02434, 02435, 02442, 02443, 02445, 02456, 02457, 02460,  
02470, 02471, 02472, 02474, 02475, 02476, 02501, 02502, 02503, 02504,  
02505, 02516, 02517, 02520, 02521, 02522, 02523, 02524, 02532, 02533,  
02534, 02544, 02545, 02546, 02547, 02550, 02551, 02552, 02553, 02554,  
02555, 02556, 02557, 02560, 02563, 02576, 02601, 02610, 02611, 02613,  
02617, 02620, 02621, 02622, 02623, 02624, 02625, 02626, 02630, 02631,  
02632, 02633, 02634, 02635, 02644, 02645, 02646, 02647, 02650, 02651,  
02652, 02653, 02654, 02655, 02656, 02657, 02660, 02661, 02662, 02663,  
02667, 02674, 02675, 02676, 02701, 02702, 02715, 02716, 02717, 02720,  
02723, 02730, 02731, 02732, 02733, 02734, 02742, 02743, 02744, 02745,  
02746, 02747, 02752, 02753, 02754, 02755, 02756, 02757, 02760, 02761,  
02772, 02773, 02776, 03001, 03004, 03005, 03010, 03011, 03012, 03013,  
03016, 03017, 03020, 03021, 03022, 03023, 03024, 03025, 03026, 03027,  
03030, 03031, 03032, 03033, 03034, 03035, 03042, 03043, 03044, 03045,  
03046, 03047, 03054, 03055, 03056, 03057, 03060, 03061, 03064, 03065,  
03076, 03101, 03102, 03103, 03105, 03110, 03111, 03114, 03115, 03116,  
03117, 03120, 03121, 03122, 03123, 03124, 03125, 03126, 03127, 03130,  
03131, 03132, 03133, 03142, 03143, 03147, 03150, 03151, 03152, 03153,  
03154, 03155, 03156, 03157, 03160, 03161, 03162, 03163, 03164, 03165,  
03166, 03167, 03172, 03173, 03175, 03176, 03201, 03204, 03206, 03214,  
03215, 03216, 03217, 03220, 03221, 03222, 03223, 03224, 03225, 03226,  
03227, 03230, 03231, 03232, 03233, 03242, 03243, 03244, 03245, 03246,  
03247, 03252, 03253, 03254, 03255, 03256, 03257, 03260, 03261, 03270,  
03271, 03272, 03273, 03274, 03275, 03276, 03301, 03302, 03303, 03305,  
03306, 03307, 03312, 03313, 03316, 03317, 03320, 03321, 03332, 03334,  
03335, 03344, 03345, 03350, 03351, 03352, 03353, 03357, 03360, 03361,  
03364, 03365, 03366, 03367, 03370, 03371, 03372, 03373, 03374, 03376,  
03401, 03403, 03417, 03420, 03424, 03425, 03431, 03433, 03434, 03435,  
03436, 03443, 03445, 03456, 03457, 03460, 03462, 03474, 03476, 03501,  
03502, 03503, 03504, 03505, 03516, 03517, 03520, 03524, 03531, 03532,  
03533, 03544, 03546, 03551, 03552, 03553, 03554, 03555, 03557, 03560,

03561, 03563, 03566, 03571, 03576, 03601, 03602, 03603, 03604, 03605,  
03606, 03607, 03610, 03611, 03612, 03613, 03614, 03615, 03616, 03617,  
03620, 03621, 03622, 03623, 03624, 03625, 03626, 03627, 03630, 03631,  
03632, 03633, 03634, 03635, 03636, 03642, 03643, 03644, 03645, 03646,  
03647, 03650, 03651, 03652, 03653, 03654, 03655, 03656, 03657, 03660,  
03661, 03662, 03663, 03664, 03665, 03666, 03667, 03670, 03671, 03672,  
03673, 03674, 03675, 03676

The 1024 words in this list shall be “valid”. All other 11-bit words *shall be* “invalid” (for check purposes, the sum of the first 512 words is 267528, and the sum of all 1024 words is  $512 \cdot 2047 = 1048064$ ).

## **Annex C (Normative), Additional Technical Requirements**

### **C1 Return Loss Definition**

For the purpose of defining Return Loss in Interface 'C', the following definition applies:

The Return Loss is defined as the ratio (in dB) of the incident power into the LEU output port to the reflected power from the LEU, with reference to the conventional impedance of 120  $\Omega$  for Interface 'C1' and 170  $\Omega$  for Interface 'C6'. In this case, the reflected power does not include the direct signal intentionally transmitted from the LEU

### **C2 Ferrite Devices for LZB cable applications**

In case the Balise is intended for applications where an LZB cable is passing the Balise, suitable ferrite devices shall be applied to the LZB cable (at least one device on each side of the Balise) for the purpose of reducing 27 MHz currents. These devices shall be positioned at a maximum distance of 0.5 m from the Balise. This presumption is mandatory when applying the herein defined test levels for testing the Balise related to induced 27 MHz current.

The following key parameter applies to the ferrite devices:

Nominal Impedance at 27 MHz  $\geq 120 \Omega$

## **Annex D (Informative), Recommended and Optional Requirements**

### **D1 Interoperability with earlier generations of ATP**

#### **D1.1 Requirements on the Tele-powering link to make Interoperability possible**

Interoperability with earlier generations of ATP systems that already operate with the Magnetic Transponder Technology in the Eurobalise frequency ranges is not required, but shall be and remain possible. This applies to earlier generations of systems operating with a Tele-powering frequency of either 27.115 MHz or 27.095 MHz.

Specifically for interoperable systems, the On-board Transmission Equipment shall be able to pulse width modulate the 27.095 MHz carrier signal by a “toggling” 50 kHz synchronisation signal.

The specification of the toggling Tele-powering signal is defined in sub-clause B1.1 of Annex B on page 136.

#### **D1.2 Transfer Syntax**

##### **D1.2.1 Intentionally Deleted**

##### **D1.2.2 Handshaking**

No handshaking shall be required.

##### **D1.2.3 Disconnection**

The Up-link telegram shall be sent uninterrupted as long as the Up-link Balise receives enough power from the On-board Antenna Unit.

##### **D1.2.4 Synchronisation**

A BCH cyclic block code shall be used. The block length shall be 341 or 1023 bits. The code shall be sent cyclically. To avoid the need for awaiting the start bit of one data block this code shall be modified in such a way that the beginning of the message content can be found after a redundancy check has been performed.

### D1.3 EMC Requirements for Tele-powering

The emission from the Eurobalise On-board Transmission Equipment transmitting the toggling Tele-powering signal is according to Figure 54 below.

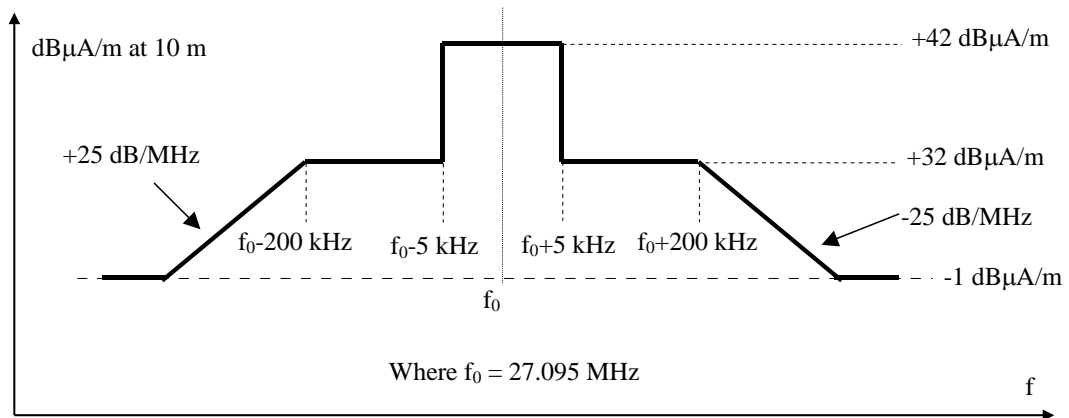


Figure 54: Requirements for interoperable mode

## D2 Intentionally Deleted

## D3 Earlier ATP systems, Considered Products

The following list of products is referred to in this document:

- Ebicab 700/900
- KVB
- RSDD
- Crocodile
- Signum

## D4 Balise Blocking Signal Output (Interface ‘C4’)

### D4.1 General

Interface ‘C4’ is optional and not mandatory. When it is implemented, it shall be used for transmitting the information to the LEU that the Balise is powered by a train. This then requires that the LEU shall not be allowed to switch telegram for a certain time period.

Details at the LEU connector will be based on mutual agreements between concerned manufacturers.

### D4.2 Physical Transmission

#### D4.2.1 Transmission Medium

##### D4.2.1.1 General

The signal shall be polarity independent. This means that interchanging the two inputs leads shall not affect the function of the interface.

The transmission shall be base band signals on electrical conductors. The conductor shall be a balanced, shielded, twisted pair cable.

##### D4.2.1.2 Cable Characteristics

The following applies.

Parameter	Limits
Maximum attenuation at 8.8 kHz	2.0 dB/km
Maximum attenuation at 100 kHz	4.0 dB/km
Characteristic Impedance at 8.8 kHz	100 $\Omega$ to 200 $\Omega$
Characteristic Impedance at 100 kHz	100 $\Omega$ to 170 $\Omega$

For the purpose of determining the cable attenuation, EN 50289 applies.

## D4.2.2 Electrical Data

### D4.2.2.1 General

The signal shall consist of temporarily lowered input impedance of the Balise. This impedance change shall be detected by the LEU through its effect on the output of the Interface 'C6' signal.

### D4.2.2.2 Signal Duration

The impedance change duration (the time when the impedance is below 'signal active' load impedance) shall be

min. 150 $\mu$ s
max. 350 $\mu$ s

### D4.2.2.3 Load Impedance of the Balise

The magnitude of the 'signal not active' load impedance shall be  
(in the relevant frequency band, 8.820 kHz  $\pm$ 0.1 kHz)

$150 \Omega <  Z  < 300 \Omega$
---------------------------------

The magnitude of the 'signal active' load impedance shall be  
(in the relevant frequency band, 8.820 kHz  $\pm$ 0.1 kHz)

$ Z  \leq 10 \% \text{ of 'signal not active' load impedance}$
--

## D4.2.3 Functional Data

The Interface 'C1' signal shall not be disturbed by the impedance change.



## D4.3 Transmission of Messages on Application Level

### D4.3.1 General

The interface shall handle a single message, defined according to this sub-clause.

### D4.3.2 Message Description

Sender:	Balise
Receiver:	LEU
Purpose:	Inhibiting telegram switching for a certain time period
Trigger event:	The Balise is sufficiently powered through Interface 'A'
Type:	Command

**Table 22: Messages**

### D4.3.3 Repetition Rate

The Balise shall send the Interface 'C4' message each time it starts being powered through the air gap. The pulse shall begin when the flux level is within the window  $\phi_{d1}-10$  dB to  $\phi_{d1}$ . An additional time delay of maximum 150  $\mu$ s after the passage of  $\phi_{d1}$  is allowed. The applicable level of  $\phi_{d1}$  is found in sub-clause 5.2.2.6 on page 63.

### D4.3.4 Re-triggerability

The LEU shall not be re-triggerable during the inhibition time.

## D4.4 Safety

No safety related requirements apply for Interface 'C4'. A failure is related to availability, not to safety.

## Annex E Intentionally Deleted

## Annex F (Informative), Cross-talk analysis method

### F1 Background

A THR (here referred to as  $THR_{\text{cross-talk}}$ ) is possible to extract from UNISIG SUBSET-091.

However,  $THR_{\text{cross-talk}}$  can not be directly interpreted as the THR for the equipment involved in potential cross-talk, because:

- It only refers to the total contribution to the ETCS top hazard coming from potential cross-talk problems in one hour. There are a number of critical scenarios where cross-talk can happen, which need to be investigated for potential barriers.
- It refers to the hazardous situation, not the technical failures. Thus, there needs to be a link established between the hazard and the technical failures.
- It needs to be split between track-side and On-board.

Therefore, the following matrix (see clause F2) shall be used as a guideline to determine the requirements for On-board and track-side respectively.

This annex contains a description of the matrix (see clause F2).

The content of the matrix is a recommendation, but the methodology shall be applicable.

The Q values for track-side are given as a guideline. The overall safety target may also be achieved by refining the Q-value considering the project specific aspects of system implementation (e.g., maintenance, engineering, etc.). The On-board values are mandatory.

### F2 Matrix

#### F2.1 General

The information herein is split into two parts:

- “Methodology to demonstrate compliance with THR”, which contains the actual calculations. This is the worksheet referred to in clause F3.
- “I/O diagrams”, which contains a description of what is meant by the failure modes for Balise failures B1, B2, and B3 in the matrix.

## F2.2 Methodology to demonstrate compliance with THR

<b>FR = Frequency of vulnerable scenarios [per hour] :</b>	2	For cross-talk distance $\geq 3$ m (normal adjacent tracks)
	0.01	For cross-talk distance 1.4 - 3 m (adjacent tracks closer than normal, e.g. before point) and Balise group contains MA or other permissive data
	0	It is not allowed to place balises closer than 1.4 m to another track

Failure mode	$\lambda$ [f/h]	MTTR	Q [-]	Cross-talk with cables				Cross-talk without cables			
				Scen 1 $\geq 3$ m	Scen 2 $\geq 3$ m	Scen 3 $\geq 3$ m	Scen 4 $\geq 3$ m	Scen 5 1.4 - 3 m	Scen 6 1.4 - 3 m	Scen 7 1.4 - 3 m	
<b>Resulting cross-talk distance :</b>											
<u>Balise group failures</u>											
B1	Balise group too sensitive to Tele-powering (<10 dB) and Out <lu3	C.S.	C.S.	5.0E-02							5.0E-02
B2	Balises energised via Interface 'C' and Out <lu3	C.S.	C.S.	5.0E-02			5.0E-02			5.0E-02	
B3	Balise group too strong (from lu3 to lu3+20 dB)	C.S.	C.S.	6.0E-06	6.0E-06	6.0E-06			6.0E-06		
<u>BTM function failures</u>											
O1	On-board equipment too sensitive to Up-link (<30 dB)			1.0E-06			1.0E-06	1.0E-06		1.0E-06	
O2	On-board equipment has too strong Tele-powering (<10 dB)			1.0E-06		1.0E-06			1.0E-06		1.0E-06
<u>External conditions</u>											
E1	Presence of approved cables in ground (first balise)			0.1	0.1	0.1	0.1	0.1			
E2	The cables layout are in a systematic way (second balise)			0.1	0.1	0.1	0.1	0.1			
E3	Above cables create a group			0.9	0.9	0.9	0.9	0.9			
E4	Resonance in both cables near Up-link frequency			0.01			0.01				
E5	Resonance in both cables near Tele-powering frequency			0.01		0.01					
E6	A second antenna is activating the balises (two antennae case)			0.01	0.01						0.01
E7	Probability that a fully correct telegram is received			0.5	0.50	0.50	0.50	0.50	0.50	0.50	0.50
<b>ProdQ</b>					2.7E-10	2.7E-16	2.3E-12	4.5E-11	3.0E-12	2.5E-08	2.5E-08
<b>Resulting Hazard Rate:</b>					5.4E-10	5.4E-16	4.5E-12	9.0E-11	3.0E-14	2.5E-10	2.5E-10
<b>Target Hazard Rate (THR for ETCS_TR05/ETCS_OB08):</b>					1.0E-09						
From					SUBSET-091						

Comment to O1: The On-board equipment is more sensitive than specified. It is assumed that it can not be more than 30 dB more sensitive than a fault-free on-board equipment.

Comment to O2: The On-board equipment is sending more Tele-powering field than specified. It is assumed that it cannot send more than 10 dB more than a fault-free on-board equipment.

Comment to E1: Cables approved according to company specific installation rules that give protection for non faulty equipment. This cable shall both pass in the vicinity of the balise (e.g., < 2m) and then pass the track at a different position.

Comment to E4: With "resonance" it is meant that current in cable is amplified due to the lay out of the cable and the impedance to ground. Without resonance it is assumed that the current at the vicinity of the track is at least 20 dB lower than what i

Comment to E5: With "resonance" it is meant that current in cable is amplified due to the lay out of the cable and the impedance to ground. Without resonance it is assumed that the current at the vicinity of the track is at least 20 dB lower than what is

### F2.3 I/O Diagrams

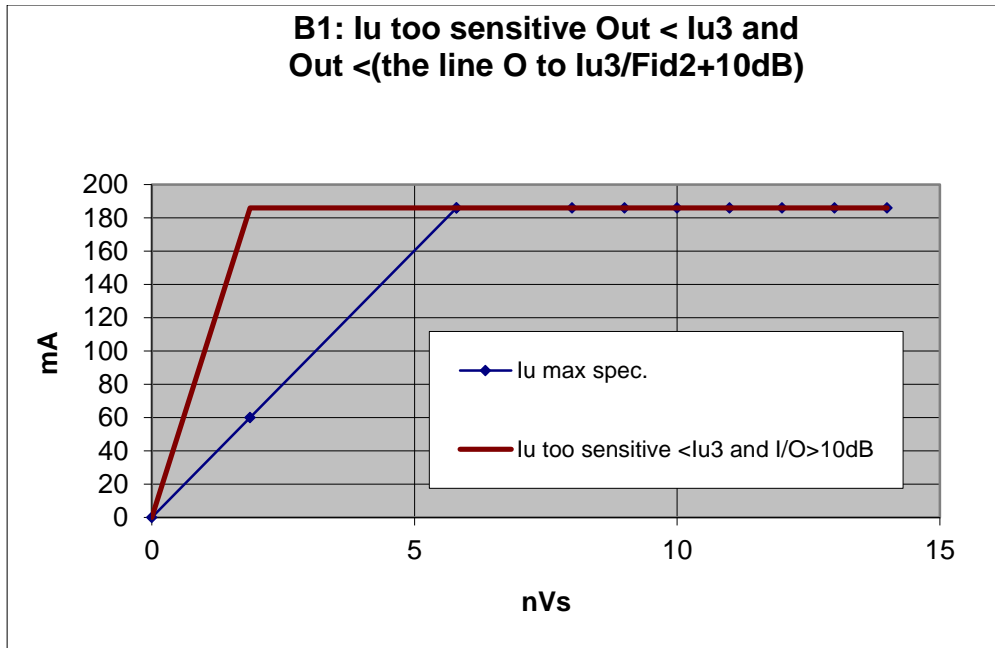


Figure 55: Reduced Size, Failure Mode B1

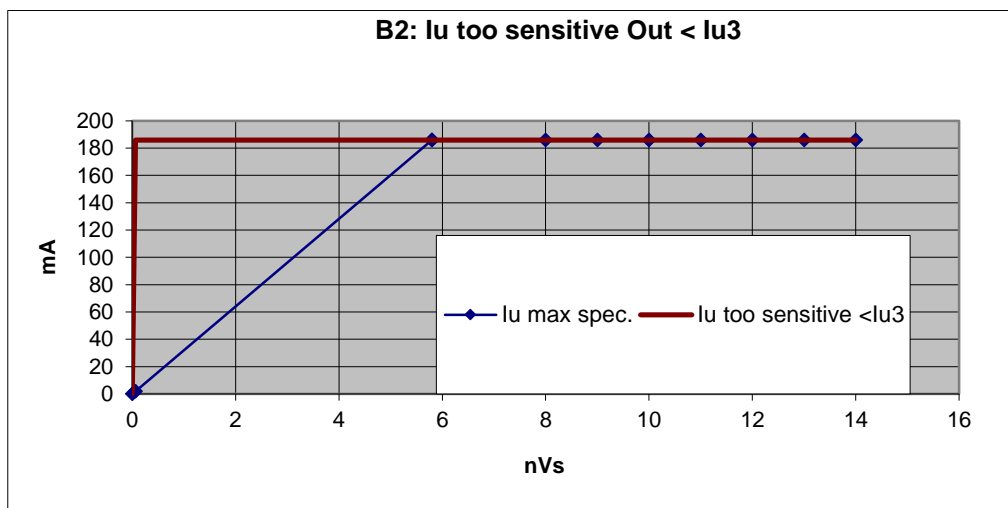


Figure 56: Reduced Size, Failure Mode B2

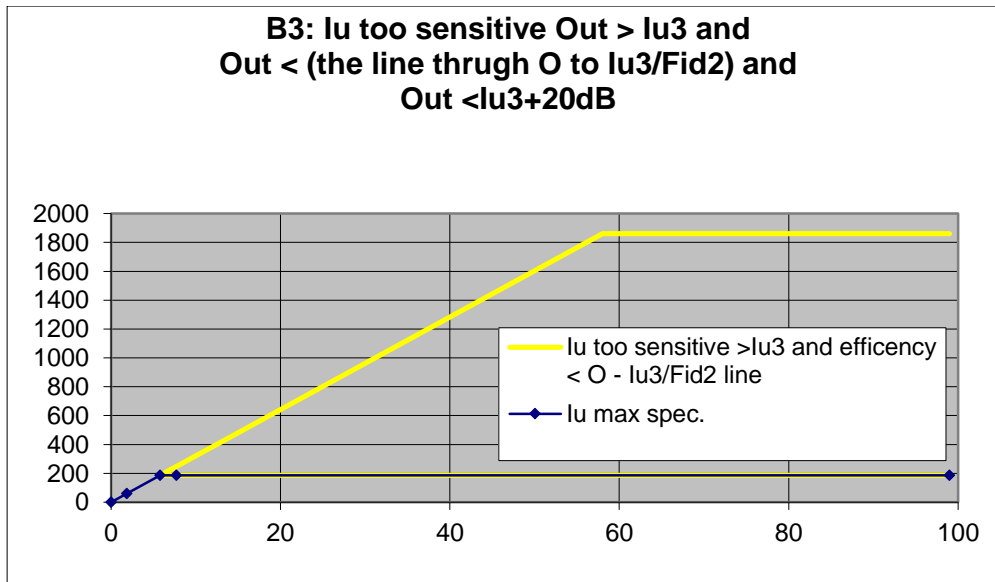


Figure 57: Reduced Size, Failure Mode B3

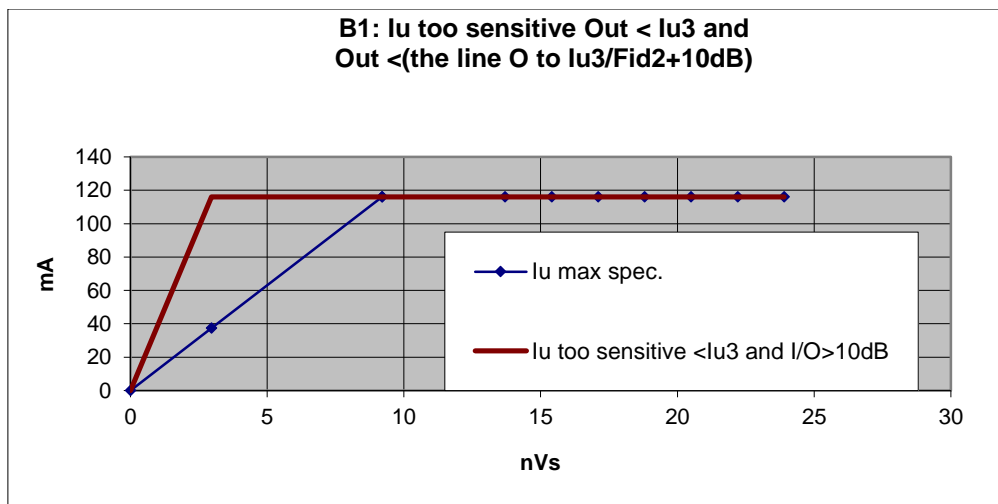


Figure 58: Standard Size, Failure Mode B1

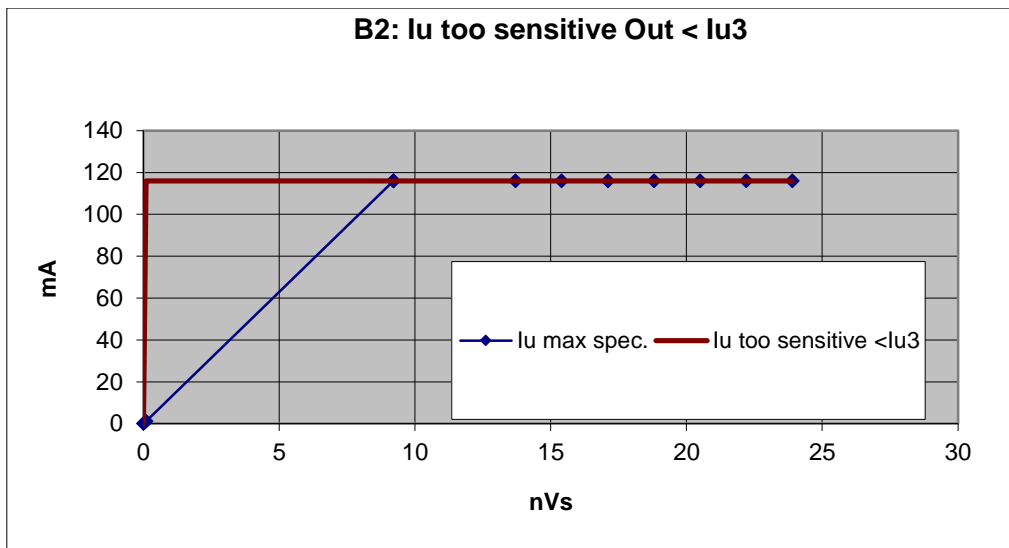


Figure 59: Standard Size, Failure Mode B2

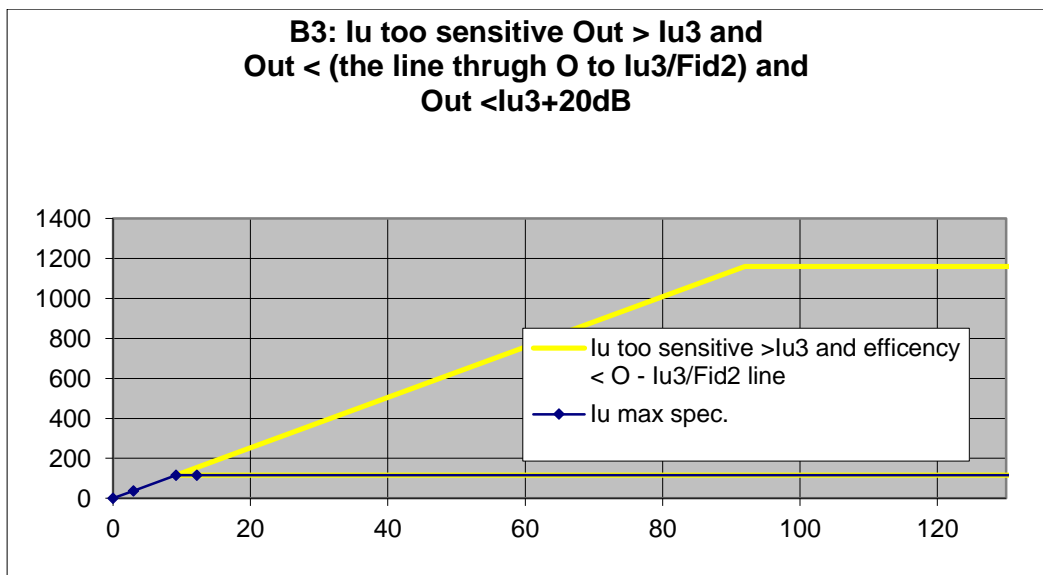


Figure 60: Standard Size, Failure Mode B3

## F3 Step-by-step Methodology

The following step-by-step methodology shall be followed when working with the cross-talk matrix of clause F2:

1. Decide on failure modes

The list of failure modes, second column, shall first be finalised according to expert judgement.

2. Set up scenarios

Each scenario is set up according to expert judgement, and is made up of the combination of the failure modes that are necessary for obtaining cross-talk. For the failure modes that are a part of the scenario, the value in fifth column, "Q-value", is copied to the scenario column.

3. Fill in frequency of vulnerable scenarios

The frequencies (FR) of the cells including "frequency of vulnerable scenarios" are filled in according to the input from UNISIG SUBSET-091.

4. Calculate Hazard Rate for all scenarios by  $HR=FR*ProdQ$

For all scenarios, the Resulting Hazard Rate is calculated according to  $HR=FR*ProdQ$ , where ProdQ is the product of all Q-values in the scenario.

5. Output: iterate on Q to achieve Hazard Rate  $< THR_{cross-talk}$  for all scenarios

The result from the matrix is obtained by manually iterating on Q for the technical failures, so that the Resulting Hazard Rate becomes less than the initial target  $THR_{cross-talk}$  (considering a reasonable margin for undefined phenomena). Finally, the yellow fields give the Requirements (Q-value) for each technical failure, after completed iteration.

Note that Q-values (unavailability) are defined herein because it allows for flexibility in MTTR (Maintenance requirements).

The Q-values and the equipment failure rate  $\lambda$  relates to each other by MTTR, or vice versa, through the equations  $Q \leq 1 - e^{-(\lambda * MTTR)}$ <sup>58</sup>, or  $Q \leq 1 - 2e^{-(\lambda * MTTR)} + e^{-(2\lambda * MTTR)}$ <sup>59</sup>. Failure rates and MTTR are supplier specific.

<sup>58</sup> Single failure calculation.

<sup>59</sup> Double failure calculation.

## F4 Description of Scenarios

The scenarios that are in the current version of the matrix are briefly outlined here:

Scenario	Description
1	Both Balises in a Balise Group are able to output too much energy. A second antenna that is moving over the Balise Group in a similar pattern as the first antenna (i.e., two trains running in parallel) energises them. Cables in the ground are present for both Balises, and they create a consistent group in the wrong track. The cables need not be resonant.
2	Both Balises in a Balise Group are able to output too much energy. They are energised by the train itself, which outputs too much Tele powering. In this case, it is also necessary to have resonance near 27 MHz; otherwise the Tele powering will not energise the Balise.
3	Both Balises in a Balise Group are erroneously energised via Interface 'C'. If cables are present, the on-board equipment can receive the Up-link signal if the receiver is too sensitive. The cables have to be resonant at 4.5 MHz.
4	A second antenna that is moving over the Balise group in a similar pattern as the first antenna (i.e., two trains running in parallel) energises them. Cables in the ground are present for both Balises, and they create a consistent group in the wrong track. The cables need not be resonant. The On-board equipment can receive the Up-link signal if the receiver is too sensitive.
5	Both Balises in a Balise Group are able to output too much energy. They are energised by the train itself, which has too strong Tele powering. The train can receive the Balise Group if the distance is closer than 3 m.
6	Both Balises in a Balise Group are erroneously energised via Interface 'C'. If the distance is closer than 3 metres, the Up-link signal can be received by the On-board equipment in case the receiver is too sensitive.
7	Both Balises in a Balise Group are too sensitive to Tele powering, so they start transmitting if they are energised by the train itself, which has too strong Tele-powering. If the distance is closer than 3 metres, the Up-link signal can be received by the train.

Note that scenarios 5, 6, and 7 (cross-talk distances from 1,4 m to 3 m) can only happen in specific cases (e.g., before points). In this case, no other train can run (due to loading gauge). Therefore, on one hand, only the single antenna case is applicable. On the other hand, from a signalling point of view, cross-talk data received from the other track should usually not contain Movement Authority (MA) or other permissive data, which are in contradiction to the current route set. Nevertheless, exceptions are possible like repositioning information. However, if two consecutive repositioning information points (Balise Groups) are found, this shall result in a safe reaction by the On-board system. This rule is defined in UNISIG SUBSET-091.

Note that some scenarios may, if justified, be excluded in specific applications, and others might be added if shown relevant.



# **Annex G (Normative), Guidelines related to Metallic Masses**

## **G1 Introduction**

This guideline provides a step by step instruction for interpreting and applying the requirements related to metallic objects. It clarifies the relations between already defined requirements. The categories herein refer to the definitions of sub-clause 6.5.2 on page 123. The requirements of the main text take precedence in the unlikely case that there become inconsistencies.

## **G2 Guidelines for Determining Applicable Rules**

### **G2.1 Step 1**

Is the top surface of the object situated lower than 80 mm below the top of rail ?

If the answer is YES, this is a category 3 object, and:

- This does not impose any constraints for the purpose of the On-board system.
- The installation of the Balises needs only to fulfil the normal installation rules as defined in sub-clauses 5.6 and 5.7.10.

If the answer is NO:

- Go to Step 2.

## G2.2 Step 2

Does the top surface of the object fit into the following ranges ?

Width [mm]	Highest distance from top of rail <sup>60</sup> [mm]
100 – 120	-80 – +42
100 – 200	-80 – 0
> 200	-80 – -50

If the answer is YES, this is a category 2 object, and:

- This does not impose any constraints for the purpose of the On-board system.
- The installation of the Balises needs to fulfil the normal installation rules as defined in sub-clauses 5.6 and 5.7.10, and in addition respect the  $d_{\text{object}} \geq 1.1$  m as defined in sub-clause 6.2.1.8 on page 111.

If the width is less than 100 mm, but the distance is still within the ranges defined in the table above, then it is a category 3 object, and:

- See consequences according section Step 1 above.

If the top surface of the object is situated higher than the upper limit of the ranges defined in the table above, then:

- Go to Step 3.

---

<sup>60</sup> A negative sign means below top of rail, and a positive sign means above top of rail.

## G2.3 Step 3

Does the top surface of the object fit into the following ranges and the length is less than 10 m ?

Width [mm]	Highest distance from top of rail <sup>61</sup> [mm]
≤ 120	+42 – +92
≤ 200	0 – +50
> 200	-50 – 0

If the answer is YES, this is a category 1 object, and:

- This does not impose any constraints for the purpose of the On-board system.
- The installation of the Balises needs to fulfil the normal installation rules as defined in sub-clauses 5.6 and 5.7.10, and in addition respect the  $d_{object} \geq 0.35 \bullet \sqrt{l_{object}} + 1.1$  m as defined in sub-clause 6.2.1.8 on page 111.

If the top surface of the object is situated higher than the upper limit of the ranges defined in the table above, then:

- Go to Step 4.

If the top surface of the object is within the ranges defined in the table above, but the length is exceeding 10 m, then:

- Go to Step 4.

## G2.4 Step 4

When reaching this step, we have an object that is considered outside the allowed metallic mask. The consequences are:

- The On-board Transmission Equipment is allowed to give an alarm to the ERTMS/ETCS Kernel. The ERTMS/ETCS Kernel shall ignore this alarm by having been informed in advance, e.g., by the appropriate Balise information (as defined in sub-clause 6.2.1.7 on page 111).
- In addition to the normal Balise installation rules as defined in sub-clauses 5.6 and 5.7.10, the distance from the end of such a metal mass to the centre of a Balise shall exceed  $d_b [m] \geq 0.2 [s] \bullet \text{Maximum Permitted Speed [km/h]} / 3.6$  (as defined in sub-clause 6.2.1.7 on page 111).
- In order to generally treat two nearby metallic objects, concluded being outside the allowed metallic mask, as constituting two separated objects, the minimum distance between such objects shall be more than  $2 \bullet (0.2 [s] \bullet \text{Maximum Permitted Speed [km/h]} / 3.6)$  (twice the distance defined in sub-clause 6.2.1.7 on page 111).

<sup>61</sup> A negative sign means below top of rail, and a positive sign means above top of rail.